

Skeleton Motors

Sleeve Bearing - Shaded Pole

Chrome Plated Shafts!

Reversible!

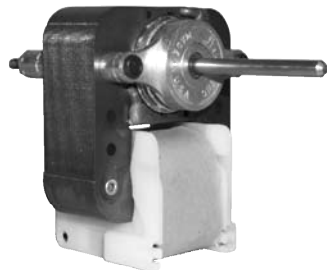

- Chromalox
- Dimplex
- Oulette
- Westcan

Long Life Bearings!

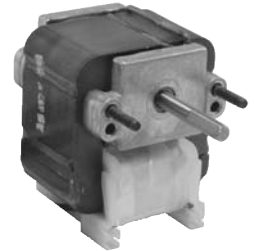

- Construction Heaters

- Blanchard
- Hussman
- Kool Air
- Rapid
- Ref Plus
- QBD

Rust Treated!

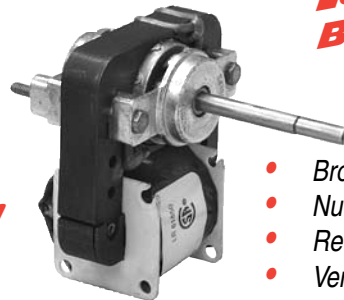









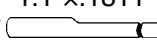

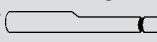
- Broan
- Nutone
- Reversomatic
- Venmar

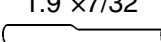
Totally Enclosed Bearing Design!

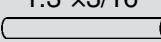
Motors

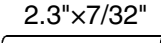
3000 R.P.M.

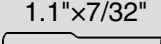
Part #	Amps	Volts	HP	Stack	Rot.	Shaft	Rated	Features	Comment
R617 	0.20	208 230	1/230	0.40	C.C.W.	1.1" x .1811" 	1900 RPM 0.22 Amps 1/285 HP	C-ring groove, Cord & spade terminal	CHROMALOX ELECTROHOME 04-290-004, 12657005, SM607
R616 	0.35 0.19	115 230	1/200	0.40	C.C.W.	1.1" x .1811" 	2100 RPM 0.37 Amps 1/250 HP	Cord w/ spade terminal, Dual Voltage	DIMPLEX/WESTCAN 2000060001, 2000060003
R630 	0.38	120	1/180	0.50	C.W.	1.9" x 7/32" 	2000 RPM 0.42 Amps 1/250 HP	Cord & plug	REVERSOMATIC EB50,(60 CFM)
R673 	0.40	115	1/110	0.63	C.W.	1.3" x 3/16" 	3000 RPM 0.40 Amps 1/110 HP	KIT-Wire leads, two speed, c/w two fan blades & mounting kit	GEN. REPLACEMENT 4673, 14007, J673, K673, SM-673
R3500 	0.40	115	1/200	0.65	C.C.W.	2.3" x 7/32" 	3000 RPM 0.40 Amps 1/200 HP	Cord & plug	GEN. REPLACEMENT 65102
R621 	0.42	115	1/180	0.55	C.W.	1.1" x 7/32" 	3000 RPM 0.42 Amps 1/180 HP	Wire leads	QBD 47-0410-001/015, IN DC5 & DC7

Skeleton Motors Continued on next page

Rotation determined opposite shaft end
Double shaft determined at lead end

Shaft length measured from hub face to shaft end











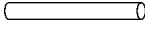



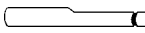

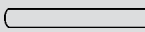
www.rotom.ca

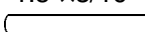
Skeleton Motors

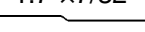
Sleeve Bearing - Shaded Pole

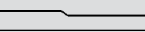
3000 R.P.M.

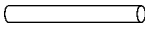
Skeleton Motors continued from previous

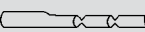
Part #	Amps	Volts	HP	Stack	Rot.	Shaft	Rated	Features	Comment
 R670	0.45	115	1/130	0.65	C.C.W.	1.3"×3/16" 	3000 RPM 0.45 Amps 1/130 HP	KIT-Cord & plug c/w two fan blades & mounting kit	65670,14001,600,700,710,EM-670,SM-670
 R602	0.45	115	1/125	0.65	C.W.	1.6"×.1811" 	3000 RPM 0.45 Amps 1/125 HP	Wire leads	RAPID REFRIGERATION
 R603	0.45	115	1/110	0.65	C.W.	2.2"×7/32" 	2400 RPM 0.52 Amps 1/125 HP	C-ring groove, cord & plug	NUTONE 81058, 81096, 81795,81826, 81827, 81993,81994, 82230
 R620	0.45 0.25	115 230	1/150	0.63	C.C.W.	1.5"×3/16" 	3000 RPM 0.45 Amps 1/150 HP	Cord & plug + 1 lead, Dual voltage	WESTWARD 14003, GEM EM671
 R3670	0.45 0.25	115 230	1/150	0.63	C.C.W.	1.5"×3/16" 	3000 RPM 0.45 Amps 1/150 HP	KIT-Cord & plug c/w two fan blades & mounting kit Dual Voltage	600, 602, 700, 702, 710,EM670, EM672, 14001, 14005
 RF100-2	0.50	115	1/155	0.65	C.C.W.	FAN	(low speed) 3000 RPM 0.55 Amps 1/260 HP	Bracket & blade inc., Fireplace blower, Two Speed	ELECTROHOME 2811-581-002,EF100-2
 R3100	0.50	115	1/130	0.65	C.W.	1.7"×7/32" 	3000 RPM 0.50 Amps 1/130 HP	KIT-Cord & plug c/w fan blade	BROAN NUTONE 65100, 33-100, C65878, EM-550,SM-550,VFM-100
 R619	0.50	115	1/130	0.50	C.W.	1.7"×7/32" 	3000 RPM 0.50 Amps 1/130 HP	Cord & plug	BROAN NUTONE FASCO K111
 R606	0.50	115	1/130	0.65	C.C.W.	1.1"×7/32" 	3000 RPM 0.50 Amps 1/130 HP	Spades	HABCO C021795
 R613	0.50	115	1/125	0.65	C.W.	2.5"×7/32" 	1600 RPM 0.55 Amps 1/260 HP	Two C-ring grooves, cord & plug	G.E. NUTONE 152B677B011, 64620

Skeleton Motors Continued on next page









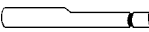

Motors

Skeleton Motors

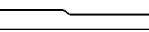
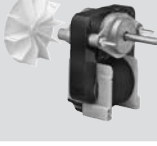
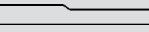
Sleeve Bearing - Shaded Pole

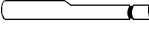
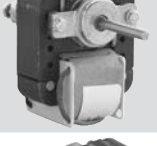
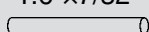
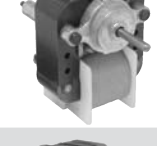
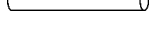
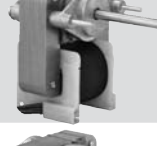
3000 R.P.M.

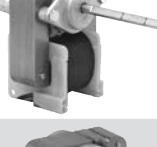
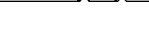
Skeleton Motors continued from previous

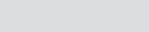
Part #	Amps	Volts	HP	Stack	Rot.	Shaft	Rated	Features	Comment
 R611	0.50	115	1/215	0.55	C.W.	1.7" x 1.811" 	1500 RPM 0.55 Amps 1/300 HP	C-ring groove, Cord & plug	ELECTROHOME SM601, NUTONE 23303, BROAN 3008001
 R634	0.50	208 230	1/40	1.10	C.C.W.	1.0" x 7/32" 	1730 RPM 0.60 Amps 1/90 HP	Cords c/w spades	WESTCAN, DIMPLEX
 R3550	0.60	115	1/115	0.55	C.W.	1.7" x 7/32" 	3000 RPM 0.60 Amps 1/115 HP	KIT-Cord & plug c/w fan blade, Rear mounting	BROAN NUTONE 65100, 33-100, C65878, EM-550, SM-550, VFM-100
 R3549	0.60	115	1/115	0.55	C.W.	1.7" x 7/32" 	3000 RPM 0.60 Amps 1/115 HP	KIT-Cord & plug c/w fan blade, Front mounting	Front Mounting R3550
 R601	0.70	115	1/80	0.90	C.W.	2.2" x 1/4" 	3000 RPM 0.70 Amps 1/80 HP	Cord & plug	BROAN NUTONE 30080007, 162,
 R3101	0.70	115	1/80	0.98	C.C.W.	1.6" x 7/32" 	3000 RPM 0.70 Amps 1/80 HP	Cord w/ three pin two speed plug	BROAN NUTONE C52367, C27987, EM551, EM554, VFM101, VFM105, R3551
 R1014	0.70	115	1/65	0.88	C.W.	1.1" x 3/16" 	3000 RPM 0.70 Amps 1/65 HP	30" cord	BLANCHARD E1014, KOOL AIR, REF PLUS, CANCOIL
 R3553	0.75	115	1/70	0.80	C.W.	1.8" x 7/32" 	3000 RPM 0.75 Amps 1/70 HP	Cord w/ ring terminal	BROAN NUTONE 65104, 33-104, C66582, EM-552, SM-553, VFM-104
 R3103	0.75	115	1/70	0.80	C.W.	2.4" x 7/32" 	3000 RPM 0.75 Amps 1/70 HP	Cord & plug,	BROAN NUTONE C63676, C66582, C68626, 27, EM552, 553, 555, VFM103, 104, 106
 R3552	0.80	115	1/55	0.90	C.W.	1.2" x 7/32" 	3000 RPM 0.80 Amps 1/55 HP	Cord & plug, Ground wire	BROAN NUTONE 65105, 33-103, C63675 EM-552, SM-552, VFM-103

Skeleton Motors Continued on next page

Rotation determined opposite shaft end
Double shaft determined at lead end











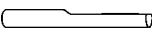

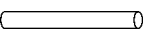

Shaft length measured from hub face to shaft end

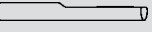
Skeleton Motors

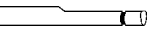
Sleeve Bearing - Shaded Pole

3000 R.P.M.

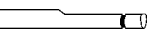
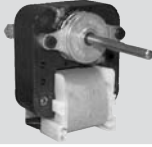
Skeleton Motors continued from previous

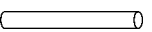
Part #	Amps	Volts	HP	Stack	Rot.	Shaft	Rated	Features	Comment
 R635	0.80	208 230	1/40	1.50	C.W.	1.5"x1/4" 	1700 RPM 0.95 Amps 1/75 HP	Cord c/w spades	CHROMALOX, WESTCAN CONSTRUCTION HEATER
 R3555	0.85	115	1/80	0.65	C.W.	2.4"x7/32" 	3000 RPM 0.85 Amps 1/80 HP	Cord & plug	BROAN NUTONE 65106,33- 106,C68627, EM- 555,SM-555, VFM-106
 R605	0.85	115	1/55	0.90	C.W.	1.7"x.1811" 	2800 RPM 0.90 Amps 1/55 HP	30" cord	HUSSMAN BLANCHARD SM605, 79103, 79104, E310131, P211116966A
 R3551	0.90	115	1/45	0.90	C.C.W.	1.4"x7/32" 	3000 RPM 0.90 Amps 1/45 HP	C-ring groove, three pin two speed plug	BROAN NUTONE 656101, 33-101, C52367, EM-551, SM-551, VFM-101
 R610	0.90	115	1/50	0.90	C.W.	1.2"x7/32" 	2400 RPM 1.00 Amps 1/60 HP	C-ring groove, cord w/ insulated spades, 2 speed	BROAN NUTONE 27898, 64586, 64964, 67846,81734, 81795, 81798, 81800
 R604	0.90	115	1/90	0.65	C.W.	1.2"x.181" 	2700 RPM 0.92 Amps 1/85 HP	Cord & plug	BROAN, NUTONE 217A9871P2, 5007S, 5018S, SM604, 5030S, 04290001, 12657006
 R3554	1.00	115	1/50	0.90	C.W.	1.5"x7/32" 	3000 RPM 1.00 Amps 1/50 HP	C-ring groove, three pin two speed plug	BROAN NUTONE 65105, 33-105, C27987, EM-554, SM-554, VFM-105
 R684	1.00	115	1/70	0.80	C.C.W.	2.1"x7/32" 	3000 RPM 1.00 Amps 1/70 HP	Cord & plug	NUVENT 2000A, D90CB 2584SP, MR. WHISPER
 R607	1.10	115	1/35	1.15	C.C.W.	1.7"x7/32" 	2300 RPM 1.30 Amps 1/50 HP	Spades	HABCO CO21617

General Replacement

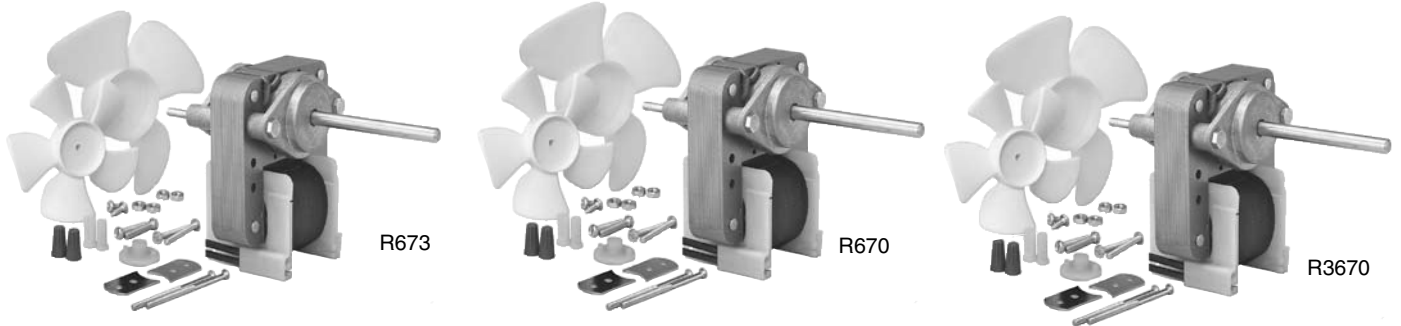

Part #	Amps	HP	Volts	Stack	Rot.	Shaft	Rated	Features	Comment
R673	0.40	1/110	115	0.63	C.W	1.3" x 3/16"	3000 RPM 0.40 Amps 1/110 HP	KIT-Wire leads, two speed, c/w two fan blades & mounting kit	GEN. REPLACEMENT 4673,14007, J673, K673, SM-673
R670	0.45	1/130	115	0.65	C.C.W.	1.3" x 3/16"	3000 RPM 0.45 Amps 1/130 HP	KIT-Cord & plug c/w two fan blades & mounting kit	GEN. REPLACEMENT 65670, 14001, 600, 700, 710, EM-670,SM-670
R3670	0.45 0.25	1/150	115 230	0.63	C.C.W.	1.5" x 3/16"	3000 RPM 0.45 Amps 1/150 HP	KIT-Cord & plug c/w two fan blades & mounting kit Blades:55432, 35431	ACME 600, 602, 700, 702, 710,EM670, EM672, 14001, 14005

Direct Replacement(Nutone)

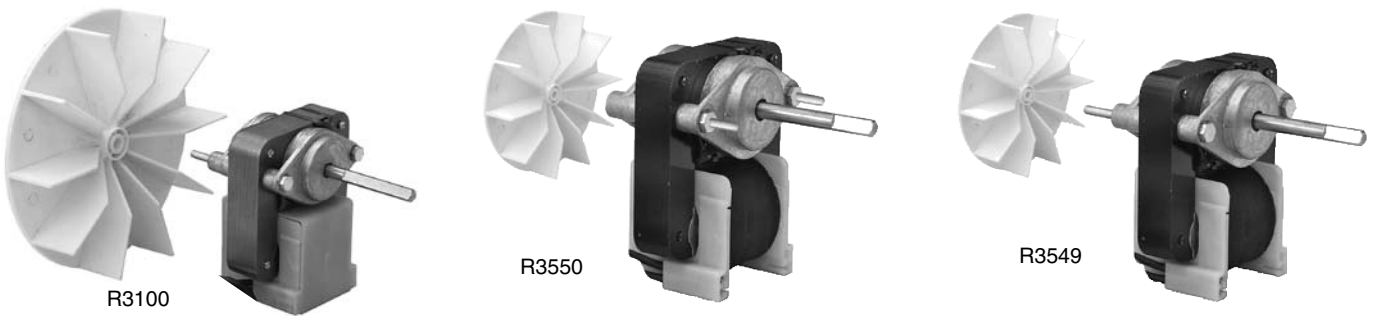

Part #	Amps	HP	Volts	Stack	Rot.	Shaft	Rated	Features	Comment
R3100	0.50	1/130	115	0.65	C.W.	1.7" x 7/32"	3000 RPM 0.50 Amps 1/130 HP	KIT-Cord & plug c/w fan blade	BROAN NUTONE 65100, 33-100, C65878, EM-550,SM-550,VFM-100
R3550	0.60	1/115	115	0.55	C.W.	1.7" x 7/32"	3000 RPM 0.60 Amps 1/115 HP	KIT-Cord & plug c/w fan blade, Rear mounting	BROAN NUTONE 65100, 33-100, C65878, EM-550,SM-550,VFM-100
R3549	0.60	1/115	115	0.55	C.W.	1.7" x 7/32"	3000 RPM 0.60 Amps 1/115 HP	KIT-Cord & plug c/w fan blade, Front mounting	Front Mounting R3550

Reversomatic Ventilation Fan Motors & Kits

Exhaust Fan Motors, Blowers, Brackets & Wheels

- 115 Volt
- Shaded Pole
- CW Rotation
- Blowers include motor, bracket & blade.

Motors

Motor Part #	Fig.	Blwr. Part #	Fig.	HP	Amps	RPM	CFM	Shaft	Bracket #	Blower #	Dia.	Width	Bore	Rot.
R630	4	RB20	1B	1/35	0.76	1/1550	60	1.90"x7/32"	A8600	A7105	5"	1 1/8"	7/32"	CCW
R260	5	RB22	2B	1/90	0.60	1/1550	75	1.10"x5/16"	A8602	A508202	5 1/16"	2"	5/16"	CCW
R261	5	-	-	1/200	0.31	1/1550	77	1.75"x5/16"						
R262	5	RB24	2B	1/40	1.10	1/1550	116	1.80"x5/16"	A8602	A508216	5 1/16"	2 5/32"	5/16"	CCW
		RB25	2B				130							
R264	6	RB26	2B	1/75	0.70	1/1550	141	2.00"x5/16"	A8604	A610215	6 1/16"	2 5/32"	5/16"	CCW
R265	5	-	-	1/90	0.65	1/1400	115	1.60"x5/16"						
R266	6	RB28	2B	1/20	1.45	1/1550	201	1.40"x5/16"	A8604	A610215	6 1/16"	2 5/32"	5/16"	CCW
R267	5	-	-	1/50	0.85	1/1550	118	1.50"x5/16"						
R2602	7	RB29	3B	1/35	1.15	1/1550	268	2.20"x1/2"	A8606	A610220	6 1/16"	2 5/32"	1/2"	CW
R2603	7	RB30	3B	1/35	1.15	1/1550	268	2.20"x1/2"	A8606	A610220	6 1/16"	2 5/32"	1/2"	CW
R2604	7	-	-	1/10	2.87	1/1550	300	2.00"x1/2"						
R2605	7	-	-	1/12	3.0	1/1050	450	1.60"x1/2"						

Comment

Motor Part #	Blower Part #	Comment
R630	RB20	013005, EB50
R260	RB22	B60, 013012, EB60
R261	-	QB60-80
R262	RB24	B100, K100
	RB25	
R264	RB26	QK100, 013020
R265	-	QB100
R266	RB28	BK100, 013024
R267	-	BB-100, 013019
R2602	RB29	SAME AS RB30 BUT OPPOSITE ROTATION
R2603	RB30	DK260, DB200, FRANKLIN 75003, 013041, 013040
R2604	-	DB300, 013062
R2605	-	QBD300

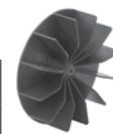

A7105



A610215

Blower
Wheels

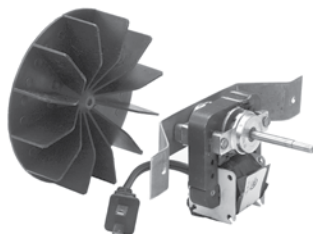

Figure 1B
RB20



Figure 2B
RB24
RB22
RB25
RB26
RB28



Figure 3B
RB30
RB29

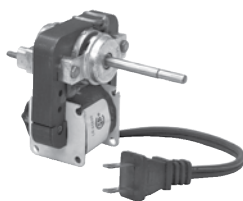

Figure 4
R630



Figure 5
R262
R260
R261
R265
R267



Figure 6
R264
R266



Figure 7
R2605

Evaporator Fan Motors

Sleeve Bearing - Shaded Pole



GEFM-1

Features

- Complete with hardware
- Use original fan blade
- Identical 2 or 3 point mounting

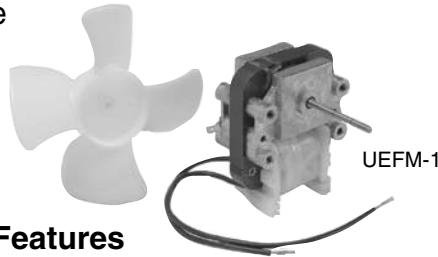

UEFM-1

Features

- Complete with fan blade (93-40421)
- Use original hardware & bracket
- Break off shaft for proper length

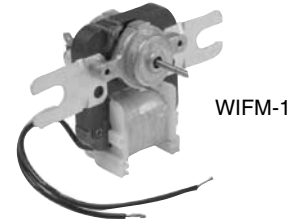

WIFM-1

Features

- Identical 2-point Westinghouse Mount or Whirlpool-Inglis bracket mount
- Complete with hardware and a fan hub.
- Use original fan blade
- Break off shaft for proper length.

Part #	HP	Volts	RPM	Amps	Rot	Stack	Shaft	Features	Comment
GEFM-1	1/350	115	2600	0.30	C.W.	0.50	1.5"x1/8"	2 or 3 point mounting	902065, WR60M103, WR60M113, WR60X104,108, 203, 5023
UEFM-1	1/500	115	2600	0.22	C.C.W.	0.38	1.5"x1/8"	Two C-ring grooves on shaft, 7" cord c/w bare wire leads, c/w fan blade	901293,292,241, 401767-101, WR60M111, 115, 1202159, 6494
WIFM-1	1/250	115	3000	0.40	C.C.W.	0.38	1.5"x1/8"	One C-ring groove on shaft, 7" cord c/w bare wire leads, Bracket mount c/w all hardware	WR60M109,902440 446,C289446,C38791,20141846,2 0144334

Humidifier Motors

Sleeve Bearing - Shaded Pole



71-2800

71-2897

Complete with applicable drive coupling

Part #	Watts	Volts	RPM	Amps	Features	Comment
71-2800	4	24	1	0.83	Gen. Replacement, Includes 3 shaft adapters	35,105,37,76,240,447,465,801,45S,90S,MD 035,60
71-2897	4	24	1	0.83	C/W mounting plates and 2 shaft adapters	Autoflow 97, Lennox WD2-2-0

Agitator Motors

Single Speed - CW Rotation

Part #	Amps	Volts	RPM	Body	Dia	Features	Comments	Fig
R6207	0.29	115	1550	2.10"	3.3"	With 2" Shaft Extension	Habco, C020106, C020114	1
R6287	0.47	115	1550	3.00"	3.3"	10" Leads	Habco, C020287	1
R4119	0.60	115	1550	3.50"	3.9"	Two Pin Plug, Thr. Shaft	Scotsman 15W	2
R6203	0.60	115	1550	3.50"	3.9"	Two Pin Plug	Cornelius 15W, QBD	2
R6208	0.60	115	1550	3.40"	3.9"	10" Leads	Habco C020942, 15W	2
R5713	0.60	115	1550	3.50"	3.9"	Cord & Plug	15W, CCW	2
R6209	0.60	115	1550	3.40"	3.9"	10" Leads	Habco C020943, 15W	2
R4110	0.80	115	1550	4.00"	3.9"	Two Pin Plug	Whirlpool, Frigidaire 23W	3
R6204	1.10	115	1550	3.50"	3.9"	Two Pin Plug	Cornelius 25W, QBD	2
R6205	1.10	115	1550	3.50"	3.9"	Two Pin Plug, Drive Pin	Cornelius 25W, QBD	2
R6206	1.70	115	1550	3.50"	3.9"	1.125" Flat on Shaft	Cornelius 50W, QBD	2

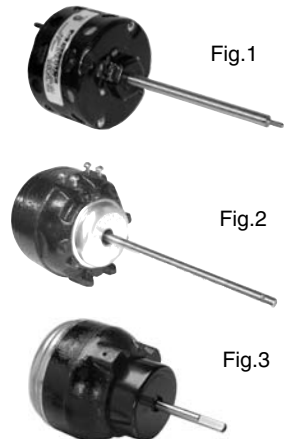

Fig.1

Fig.2

Fig.3

Rotation determined opposite shaft end
Double shaft determined at lead end

Shaft length measured from hub
face to shaft end

Dash Fans

Typical Applications:

Mobile Homes
Campers
Buses
Trucks
Cars

R961
R960
R963



12 & 24 Volt D.C. Dash Fans

Part #	CFM	Voltage	RPM	Amps	Speed	Rotation	Features	Comment
R960	180	12	3000	2.20	TWO	C.C.W.	Black	2899-006-077, MOBILE HOMES,
R961	180	12	3000	2.20	TWO	C.C.W.	Black	2899-006-021, MOBILE HOMES,
R963	190	24	3200	1.20	TWO	C.C.W.	Black	2899-006-033, MOBILE HOMES,

3.0" Diameter - Series Wound & Permanent Magnet

Typical Applications:

Bus & Truck HVAC

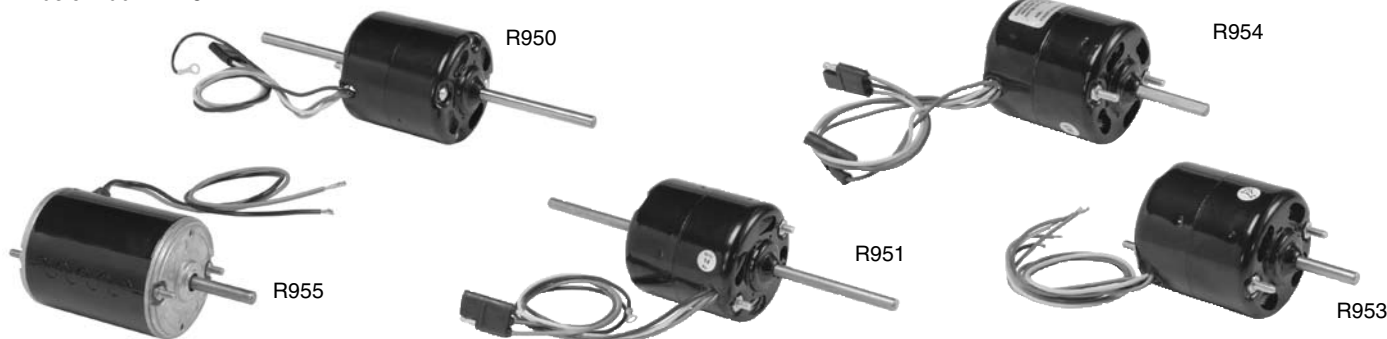

12 & 24 Volt D.C. 3.0" Motors

Part #	Watts	Voltage	RPM	Amps	Speed	Rotation	Shaft	Comment
R953	50	12	3200	6.80	TWO	REV.	1.8"x5/16"	2807-510-146
R951	80	24	3500	6.20	THREE	C.C.W.	3.5"x5/16"x3.5"	2899-006-021
R955	90	12	3000	10.00	ONE	REV.	1.7"x5/16"	2809-531-146
R950	91	12	4100	12.80	THREE	C.C.W.	3.5"x5/16"x3.5"	2807-510-143
R954	95	12	4200	12.30	THREE	REV.	2.1"x5/16"	2807-510-154

Bilge Blowers

Typical Applications:

Boat Bilges
Galley
Engine Rooms
Campers

UL Approved - Guide BCHW # MQ302
BIA Listed Code 190100

92-A286 Kit For Universal Mounting



R958
R959

12 & 24 Volt D.C. Bilge Blowers

Part #	CFM	Voltage	RPM	Amps	Speed	Rotation	Features	Comment
R959	125	24	4800	4.00	ONE	C.W.	Mounting Flange	2898-125-002 BCHW/#MQ302
R958	128	12	4800	8.00	ONE	C.W.	Mounting Flange	2898-125-001, BCHW/# MQ302,

Open Construction - Single Shaft

Sleeve & Ball Bearing - Shaded Pole & P.S.C.



Fig. 1
R302



Fig. 2
R304 R317
R308 R320
R309 R325
R311 R395
R315



Fig. 3
R306
R322
R410



Fig. 4
R337
R90015
R90014



Fig. 5
R370
R371
R91125



Fig. 6
R130
R326

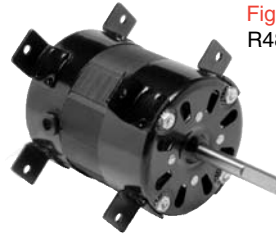

Fig. 7
R480



Fig. 8
R90575

1550 RPM-115, 208, 230 volts

Part #	Amps	Volts	H.P.	Rot.	Shaft	Body	Feature	Comment	Fig.
R302	0.20	230	1/100	C.W.	2.0"x1/4"	2.25	4 studs rear	Camco, FPE	1
R325	0.33	115	1/125	C.C.W.	2.3"x1/4"	2.09	16" leads shaft end	W.C.Woods	2
R410	0.35	115	1/130	C.W.	2.0"x5/16"	2.75	L.K.Fitting-int.fan	Enterprise Fdry.	3
R371	0.38	230	1/20	C.W.	2.6"x5/16"	4.00	PSC/Cap. inc., Plug, Ball Bearing	Keeprite 501909, 501525	5
R337	0.40	115	1/200	C.C.W.	1.5"x1/4"	2.30	2 speed motor	Hunter 902538	4
R326	0.40	115	1/110	C.W.	1.4"x1/4"	2.09	U Brk. 35" leads	Blanchard E1001,2,3	6
R311	0.47	115	1/100	C.W.	1.2"x5/16"	2.09	Hex Hubs, cord & plug	Nutone 81176, 23405	2
R320	0.47	115	1/100	C.W.	1.3"x1/4"	2.10	18" leads	Moyer & Diebel	2
R91125	0.50	208/230	1/12	CW	2.63"x5/16"	3.66	PSC/Cap.Inc	9720A, D1125, 41125	5
R315	0.53	115	1/90	C.C.W.	1.2"x1/4"	2.09	Hex Hubs, cord & plug	Nutone 82598, 82599, 65070	2
R317	0.60	115	1/65	C.C.W.	1.6"x1/4"	2.30	Hex hubs	Nutone 65072	2
R306	0.65	115	1/60	C.W.	1.2"x1/4"	2.92	Internal Fan / oilers	Coleman	3
R309	0.68	115	1/70	C.W.	2.4"x1/4"	2.00	12.5" leads	Gen. Replacement	2
R90015	0.70	115	1/70	CW	2.24"x1/4"	2.14	4 Studs front & rear	15, D121, 40121, 3M539	4
R90014	0.70	115	1/70	CCW	2.24"x1/4"	2.14	4 Studs front & rear	14, D120, 40120, 3M538	4
R308	0.70	115	1/70	C.C.W.	2.3"x1/4"	2.00	12.5" leads	Gen. Replacement	2
R370	0.75	115	1/20	C.W.	2.8"x5/16"	4.00	Cap.inc.Plug, Ball Bearing	Keeprite 501895, 505124	5
R322	0.80	115	1/60	C.W.	1.3"x1/4"	2.00	Cord & plug	Broan 30080111, 112	3
R480	0.80	208/230	1/30	C.C.W.	2.4"x3/8"	4.00	4 Lugs Front and Back	Chromalox/Westcan	7
R130	0.80	230	1/25	C.W.	1.5"x5/16"	2.72	Single U Brk, 35" leads	Blanchard0.	6
R395	0.81	208/230	1/20	C.W.	2.5"x5/16"	2.75	Cord & plug	Larkin 2531195	2
R90575	0.89	230	1/20	CW	2.48"x5/16"	2.75	2 Pin plug	575, D1103, 41195,	8
R304	0.89	115	1/40	C.W.	1.5"x1/4"	2.50	LK fitting.	Nutone	2

3.3" Motors continued on next page.

3.3" Motors



Open Construction - Single Shaft

Sleeve & Ball Bearing - Shaded Pole & P.S.C.



Fig. 1
R359 R90188
R499 R90026
R1053 R90027
R90189 R90514



Fig. 2
R291
R319
R360
R362
R363



Fig. 3
R340



Fig. 4
R438



Fig. 5
R350
R409



Fig. 6
R205



Fig. 7
R90573
R90752



Fig. 8
R303

1550 RPM-115, 208, 230 volts

3.3" Motors continued from previous page

Part #	Amps	Volts	H.P.	Rot.	Shaft	Body	Feature	Comment	Fig.
R90189	0.90	230	1/20	CW	2.24"x5/16"	2.75	4 Studs front & rear	D189, 40189	1
R90188	0.90	230	1/20	CCW	2.24"x5/16"	2.75	4 Studs front & rear	D188, 40188	1
R319	0.90	115	1/50	C.C.W.	2.2"x1/4"	2.10	Cord & plug, 1430 RPM	Camco/Nutone	2
R340	0.90	230	1/20	C.C.W.	2.0"x5/16"	3.15	2 studs front	G.E.	3
R362	0.90	115	1/45	C.C.W.	2.3"x5/6"	2.25"	4 Studs front & rear	U.E. 26,28, D126, D130, 2868-507-150	2
R363	0.90	115	1/45	C.W.	2.3"x5/6"	2.25"	4 Studs front & rear	U.E. 27,29, D127, D131 2868-507-151	2
R360	1.00	115	1/35	C.W.	1.6"x1/4"	2.50	3 studs front	Keeprite 504249	2
R359	1.00	230	1/20	C.C.W.	3.2"x5/16"	3.30	2 Pin plug	Blanchard E1059	1
R1053	1.00	230	1/20	C.C.W.	3.2"x5/16"	3.00	2 Pin plug	Blanchard E1053	1
R499	1.00	115	1/15	C.C.W.	2.3"x5/16"	4.55	PSC (4/370), 4 studs front, 1625 RPM	Grainger 3M499B	1
R438	1.05	115	1/14	C.W.	1.5"x5/16"	4.25	PSC (4/370), 3 lugs, 1600 RPM, Two speed	Venmar HRV 01038	4
R90027	1.10	115	1/40	CW	2.24"x5/16"	2.44	4 Studs front & rear	27, D127, 40127, 3M544	1
R90026	1.10	115	1/40	CCW	2.24"x5/16"	2.44	4 Studs front & rear	26, D126, 40126, 3M543	1
R409	1.10	115	1/40	C.C.W.	1.5"x5/16"	2.20	20" leads, Ball Bearing	Gen. Replacement	5
R291	1.10	115	1/30	C.W.	1.6"x1/4"	2.80	3 studs front	Keeprite 1043291	2
R205	1.20	115	1/35	C.W.	1.8"x1/4"	2.50	Trinangular Brk. + cord & plug.	Keeprite 11796-8	6
R350	1.20	115	1/55	C.W.	1.5"x5/16"	2.85	1050 RPM, Two Speed	Mark Hot	5
R90573	1.20	208/230	1/15	CCW	3.03"x5/16"	3.50	2 Pin plug	573A, D1126, 45008T	7
R90752	1.30	120	1/40	CW	1.3"x1/4"	2.15	1500 RPM	40752	7
R90514	1.30	115	1/30	CCW	2.38"x5/16"	2.69	4 Studs front & rear	D514, 40514	1
R303	1.40	115	1/25	C.C.W.	3.3"x5/16"	3.84	Triangular Brk, Int.Fan, B/B	Trane Unit Htr.	8

3.3" Motors continued on next page.

Open Construction - Single Shaft

Sleeve & Ball Bearing - Shaded Pole & P.S.C.



Motors

1550 RPM-115, 208, 230 volts

3.3" Motors continued from previous page

Part #	Amps	Volts	H.P.	Rot.	Shaft	Body	Feature	Comment	Fig.
R318	1.50	115	1/25	C.W.	2.8"x5/16"	2.80	U Brk	Blanchard 79105	1
R332	1.50	115	1/25	C.W.	1.5"x5/16"	2.60	2 Pin plug	Bohn / Blanchard	2
R336	1.50	115	1/25	C.C.W.	1.2"x1/4"	2.60	Special leads	W.C.Woods	3
R384	1.50	115	1/25	C.W.	1.5"x5/16"	2.80	Conduit Box	DELHI 8840011, RB245, 8213915061	9
R90031	1.60	115	1/25	CW	2.57"x5/16"	2.75	4 Studs front & rear	31, 40031	4
R90030	1.60	115	1/25	CCW	2.57"x5/16"	2.75	4 Studs front & rear	30, 40030	4
R394	1.60	115	1/20	C.W.	2.5"x5/16"	2.75	Cord & Plug	Larkin 2531194	5
R368	1.72	115	1/20	C.W.	2.5"x5/16"	2.80	4 Studs + 2 pin plug	Ref. Plus RMT 0012	4
R356	1.75	115	1/20	C.C.W.	2.2"x5/16"	2.60	4 studs front & rear	Gen. Replacement	5
R357	1.75	115	1/20	C.W.	2.3"x5/16"	2.60	4 studs front & rear	Gen. Replacement	5
R421	1.75	115	1/15	C.C.W.	2.3"x5/16"	3.54	Internal Fan Cooled, Studs front	Coleman	3
R90572	1.80	115	1/15	CCW	3.03"x5/16"	3.00	2 Pin Plug	572A, D1124, 45008S	6
R90133	1.80	115	1/20	CW	2.24"x5/16"	2.75	4 studs front & rear	D133, 40133	4
R90132	1.80	115	1/20	CCW	2.24"x5/16"	2.75	4 studs front & rear	D132, 40132, 3M547	4
R90574	1.90	115	1/20	CW	2.48"x5/16"	2.75	2 Pin plug	574, D1101, 41194	6
R358	2.00	115	1/20	C.C.W.	3.2"x5/16"	3.30	2 Pin plug	Blanchard E1058	4
R1052	2.00	115	1/20	C.C.W.	3.2"x5/16"	3.00	2 Pin plug	Blanchard E1052	4
R90672	2.10	115 208/230	1/15	CCW	2.24"x5/16"	5.00	Mechanical Duty	672, 81672	7
R90671	2.10	115 208/230	1/15	CW	2.24"x5/16"	5.00	Mechanical Duty	671, 81671	7
R355	2.20	115	1/15	C.W.	1.9"x5/16"	3.11	Hex Hubs	Nutone	3
R313	2.30	115	1/15	C.C.W.	3.0"x5/16"	3.60	2 Pin plug	Bohn	3
R422	2.90	115	1/6	C.W.	2.1"x3/8"	4.90	3 lugs, 3/1690 RPM	Venmar HRV 02209	8

Rotation determined opposite shaft end
Double shaft determined at lead end

Shaft length measured from hub
face to shaft end

3.3" Motors



Totally Enclosed - Single Shaft

Sleeve & Ball Bearing - Shaded Pole



Fig. 1
R212
R215



Fig. 2
R230
R401
R502
R503
R506
R511
R512



Fig. 3
R260
R261
R265
R222
R500



Fig. 4
R206
R403



Fig. 5
R204
R210
R217
R231
R232



Fig. 6
R227
R228



Fig. 7
R454



Fig. 8
R224
R225
R223

1550 RPM-115, 208, 230 Volt

Part #	Amps	Volts	HP	Rot	Shaft	Body	Features	Comment	Fig.
R215	0.22	230	1/115	C.C.W.	2.3"x5/16"	2.09	Triangular Brk.Front	Electric Unit Htrs.	1
R511	0.28	230	1/100	C.W.	2.0"x1/4"	2.10	C ring groove, 1350 RPM	FPE, Electrohome SN8401	2
R261	0.33	115	1/170	C.W.	1.7"x5/16"	2.09	Cord & plug	Reversomatic	3
R403	0.33	115	1/145	C.W.	1.5"x1/4"	2.75	On/off switch on mtr., 72" cord & plug.	Enterprise Fdry., Newmac	4
R401	0.35	115	1/165	C.C.W.	1.5"x1/4"	2.09	Conduit sleeve	Enterprise Fdry.	2
R503	0.40	115	1/130	C.W.	2.4"x1/4"	2.09	Notched shaft	Nutone, Air King 2108375001	2
R210	0.40	230	1/50	C.C.W.	1.5"x1/4"	2.40	24" Leads	Caloritech	5
R506	0.43	115	1/240	C.W.	2.0"x1/4"	1.90	Cord & plug, 1400 RPM	2N870, Nutone 80725	2
R227	0.45	115	1/110	C.C.W.	2.3"x1/4"	2.09	Cord & plug	Gen. Replacement	6
R228	0.45	115	1/110	C.W.	2.1"x1/4"	2.09	Cord & plug	Gen. Replacement	6
R502	0.50	115	1/100	C.C.W.	3.4"x1/4"	2.44	72"Cord & Plug	Electrohome	2
R217	0.50	240	1/35	C.W.	1.2"x1/4"	2.40	Electric heater, 1450 RPM	Chromalox	5
R212	0.55	230	1/30	C.C.W.	3.5"x5/16"	2.80	Triangular Brk. Ball Bearing	Chromalox electric heater	1
R206	0.56	115	1/80	C.W.	1.4"x1/4"	2.09	Two speed plug.	Miami-Carey, Air King, B.D. Waite	4
R512	0.62	115	1/75	C.W.	1.0"x1/4"	2.09	C ring groove	Electrohome 2N10201, 2N11601	2
R230	0.64	115	1/70	C.C.W.	1.3"x1/4"	2.30	2800 RPM	Coldstream	2
R260	0.65	115	1/80	C.W.	1.1"x5/16"	2.09	Cord & plug	Reversomatic	3
R265	0.65	115	1/75	C.W.	1.6"x5/16"	2.09	Cord & plug	Reversomatic	3
R500	0.66	115	1/70	C.C.W.	2.1"x1/4"	2.35	2 studs rear	Tweed Steel	3
R204	0.70	115	1/80	C.C.W.	1.1"x1/4"	2.10	Threaded shaft, 1100 RPM	Nutone, Leigh Metal	5
R231	0.70	115	1/70	C.W.	1.3"x1/4"	2.50	Two speed plug, 2800 RPM	Nutone	5
R232	0.70	115	1/70	C.C.W.	1.3"x1/4"	2.50	Two speed plug.	Nutone	5
R222	0.72	115	1/75	C.C.W.	2.3"x1/4"	2.09	Cord & plug	Nutone	3
R454	0.74	230	1/25	C.C.W.	2.5"x5/16"	4.25	Mechanical duty	Gen. Replacement	7
R224	0.75	115	1/50	C.C.W.	C.C.W.	2.20	Cord & plug, 1500 RPM	Gen. Replacement	8
R223	0.75	115	1/50	C.C.W.	C.C.W.	2.20	2 Studs front	Sylvan Source	8
R225	0.75	115	1/50	C.W.	2.3"x1/4"	2.20	Cord & plug, 1500 RPM	Gen. Replacement	8

3.3" Motors continued on next page.

Totally Enclosed - Single Shaft

Sleeve Bearing - Shaded Pole & P.S.C.

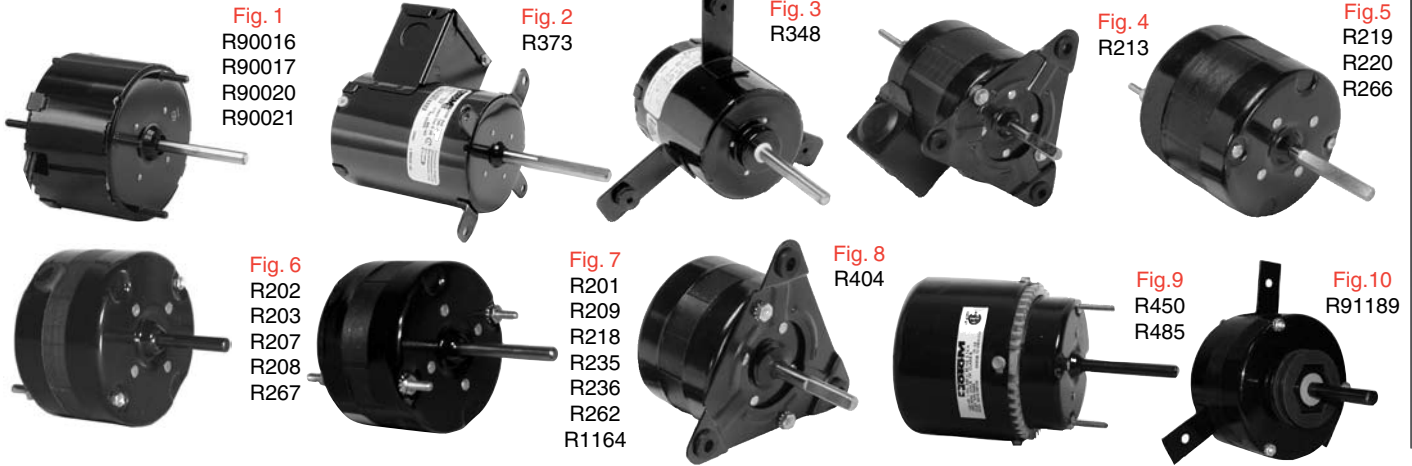

1550 RPM-115, 208, 230 Volt

3.3" Motors continued from previous page

Part #	Amps	Volts	HP	Rot	Shaft	Body	Features	Comment	Fig.
R90021	0.80	115	1/50	CW	2.24"x1/4"	2.44	4 studs front & rear	21, D125, 40125, 3M661	1
R90020	0.80	115	1/50	CCW	2.24"x1/4"	2.44	4 studs front & rear	20, D124, 40124, 3M554	1
R90017	0.60	115	1/80	CW	2.24"x1/4"	2.14	4 studs front & rear	17, D123, 40123	1
R90016	0.60	115	1/80	CCW	2.24"x1/4"	2.14	4 studs front & rear	16, D122, 40122	1
R207	0.80	115	1/70	C.W.	1.5"x1/4"	2.00	Cord & plug	Nutone	6
R203	0.80	115	1/70	C.C.W.	1.5"x1/4"	2.10	Cord & plug	Threaded shaft	6
R267	0.80	115	1/50	C.W.	1.5"x5/16"	2.25	Cord & plug	Reversomatic	6
R201	0.85	115	1/50	C.W.	2.3"x1/4"	2.20	1430 RPM	Camco/Nutone	7
R404	0.85	115	1/50	C.C.W.	1.8"x5/16"	2.48	Triangular Brk.	Clawsey Sohrt	8
R209	0.87	115	1/45	C.W.	1.5"x5/16"	2.30	Cord & plug	Nutone/Broan	7
R235	0.90	115	1/80	C.C.W.	1/4"x1.1"	2.35	C-ring groove, 1050 RPM	W.C.Woods	7
R373	0.90	115	1/15	C.C.W.	3.3"x3/8"	4.50	PSC/Cap. inc., 1400 RPM	Dayton greenhouse motor	2
R236	1.00	115	1/50	C.C.W.	1.1"x1/4"	2.25	C ring groove, Two speed, 1575 RPM	W.C.Woods	7
R218	1.00	115	1/40	C.C.W.	1.9"x1/4"	2.60	18" Leads	Gen. Replacement	7
R202	1.00	115	1/40	C.W.	1.3"x1/4"	2.50	Two speed plug	Nutone	6
R208	1.00	115	1/40	C.W.	1.9"x1/4"	2.60	2 studs front & rear	Gen. Replacement	6
R262	1.00	115	1/40	C.W.	1.5"x5/16"	2.40	Cord & plug	Reversomatic	7
R348	1.12	115	1/15	C.C.W.	3.4"x3/8"	4.10	PSC/inc., 3 ears, two speed	Vanee HRV M1703	3
R485	1.27	230	1/15	C.W.	2.0"x5/16"	4.50	Mechanical Duty, 1280 RPM, two speed	Gen. Replacement	9
R1164	1.30	115/230	1/25	C.C.W.	2.4"x5/16"	2.75	4 studs front & rear	431, 432, D1164, 2868-513-419	7
R450	1.35	115	1/25	C.C.W.	2.5"x5/16"	4.25	Mechanical Duty	Gen. Replacement	9
R213	1.40	115	1/25	C.C.W.	1.7"x5/16"	3.10	Triangular Brk/Box	Trane/Lincoln/Chromalox	4
R91189	1.6/8	115 208/230	1/20	CCW	1.65"x5/16"	3.15	3 ears	D1189, 41189	10
R219	1.60	115	1/20	C.W.	2.2"x5/16"	2.80	Cord & plug	Nutone	5
R220	1.60	115	1/20	C.C.W.	1.2"x5/16"	2.80	Cord & plug	Woods, Miami-Carey	5
R266	1.65	115	1/20	C.W.	1.4"x5/16"	2.80	Cord & plug	Reversomatic	5

3.3" Motors continued on next page.

Rotation determined opposite shaft end
Double shaft determined at lead end

Shaft length measured from hub
face to shaft end

3.3" Motors



Open - 3000 RPM - Single / Double Shaft

Sleeve & Ball Bearing - Shaded Pole & P.S.C. - 115 Volts



Single Shaft

Part #	Amps.	H.P.	Rotation	Shaft	Body	Feature	Comment	Fig.
R305	0.85	1/60	C.W.	1.5"x1/4"	2.30	Cord & plug, 2800 RPM	Nutone	1
R307	1.10	1/30	C.C.W.	1.3"x1/4"	3.30	Stud mounting	Keeprite	2
R312	1.20	1/12	C.C.W.	4.0"x5/16"	4.63	P.S.C (4/370), Internal Fan, Ball Bearing, 3250 RPM	Engineered Air 101322	3
R334	2.30	1/15	C.C.W.	1.5"x1/4"	4.25	Internal Fan	Torin/Clare	4



Double Shaft

Part #	Amps.	H.P.	Rotation	Shaft	Body	Feature	Comment	Fig.
R413	0.95	1/35	C.C.W.	2.3"x1/4"x2.5"	3.00	Int.Fan, cord & plug	Gen. Replacement	1
R445	1.10	1/35	C.W.	1.5"x1/4"x1.5"	2.80	75" cord & plug	Gen. Replacement	1

Totally Enclosed - 3000 RPM - Single / Double Shaft

Sleeve & Ball Bearing - Shaded Pole & P.S.C. - 115 Volts



Single Shaft

Part #	Amps	HP	Rot	Shaft	Body	Features	Comment	Fig.
R90402	0.75	1/60	CCW	1.73"x1/4"	2.36	4 studs front & rear	D402, 40402	1
R90616	0.75	1/70	CW	0.96"x1/4"	2.28	Cord & plug	82500	1
R214	0.76	1/50	C.W.	1.5"x1/4"	2.80	2700 RPM	Nutone	2
R233	0.84	1/45	C.C.W.	1.8"x1/4"	2.50	2 Speed Plug	Nutone	4
R200	1.00	1/50	C.C.W.	1.2"x1/4"	2.60	2 Speed Plug	Miami-Carey	3



Double Shaft

Part #	Amps.	H.P.	Rotation	Shaft	Body	Feature	Comment	Fig.
R412	0.55	1/75	C.C.W.	2.3"x1/4"x2.3"	2.40	22" cord & plug	Gen. Replacement	1
R425	1.00	1/40	C.W.	2.5"x1/4"x2.5"	2.60	4 studs front & back, two speed	Gen. Replacement	1

Open - Double Shaft

Sleeve Bearing - Shaded Pole & P.S.C.



Fig. 1
R408



Fig. 2
R415
R455
R465
R470
R489
R510
R717



Fig. 3
R366
R462
R90324



Fig. 4
R467

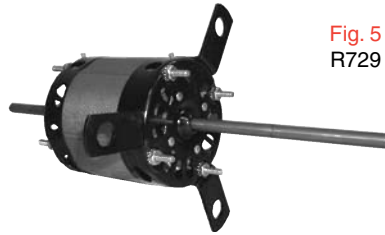

Fig. 5
R729



Fig. 6
R439

1550 RPM-115 Volt

Part #	Amps	H.P.	Rotation	Shaft	Body	Feature	Comment	Fig.
R408	0.72	1/65	C.C.W.	1.6"x1/4"x1.6"	2.25	Two speed	Lau Products	1
R489	0.74	1/70	C.W.	3.0"x5/16"x3.8"	2.30	Control wires, three speed	Elmira Stove	2
R415	0.85	1/65	C.C.W.	2.3"x1/4"x2.3"	2.92	Int.Fan, cord & plug	Gen. Replacement	2
R510	1.10	1/45	C.W.	1.1"x1/4"x1.5"	2.25	C ring groove, three speed	Camco/Woods	2
R462	1.10	1/17	C.C.W.	3.5"x3/8"x3.5"	4.00	2 studs side, three speed	Venmar HRV 02102	3
R467	1.40	1/25	C.W.	1.8"x5/16"x1.8"	3.10	Hex Hubs, Molex plug	Broan	4
R470	1.40	1/25	C.W.	3.8"x5/16"x3.7"	3.00	Hex Hubs, studs	Nutone	2
R366	1.70	1/7	C.W.	3.0"x3/8"x3.0"	4.75	2 studs side, three speed	Venmar HRV 02100	3
R455	1.90	1/25	C.W.	4.6"x5/16"x4.6"	3.20	Three speed	Gen. Replacement	2
R717	2.00	1/15	C.C.W.	5.0"x5/16"x3.5"	3.50	Three speed	Window A/C	2
R729	2.00	1/15	C.C.W.	3.5"x5/16"x5.0"	3.50	Three lugs, three speed	Window A/C	5
R90324	2.10	1/25	CW	1.95"x5/16"x1.95"	2.92	Hex hubs	324, 82324	3
R465	2.25	1/15	C.C.W.	2.3"x5/16"x2.3"	4.00	Internal Fan, three speed	Nutech/Elmira stoves	2
R439	2.60	1/14	C.C.W.	6.4"x5/16"x6.4"	3.25	4 studs, oilers, two speed	Gen. Replacement	6

Totally Enclosed - Double Shaft

Sleeve Bearing - Shaded Pole & P.S.C.



Fig. 1
R416

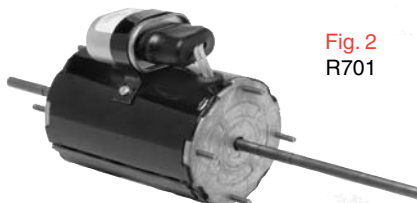

Fig. 2
R701



Fig. 3
R440

1550 RPM-115 Volt

Part #	Amps.	H.P.	Rotation	Shaft	Body	Feature	Comment	Fig.
R416	0.76	1/60	C.C.W.	2.3"x1/4"x2.3"	2.20	Cord & plug	72" leads	1
R701	1.30	1/12	C.C.W.	5.0"x5/16"x2.7"	4.60	4 studs front & rear	P.S.C./Cap inc., Window A/C, three speed	2
R440	1.60	1/20	C.W.	3.8"x5/16"x3.8"	3.80	Hex hubs, cord & plug	Nutone	3

Rotation determined opposite shaft end
Double shaft determined at lead end

Shaft length measured from hub face to shaft end

3.3" Motors



Permanent Split Capacitor

Motors



Fig.1
R370
R371

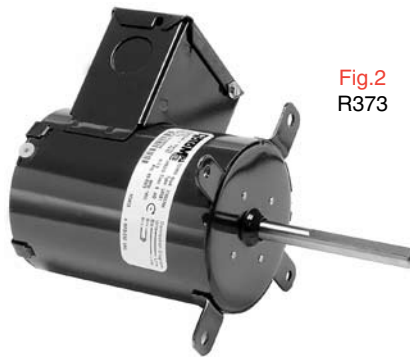

Fig.2
R373



Fig.3
R499
R312



Fig.4
R348



Fig.5
R366
R462

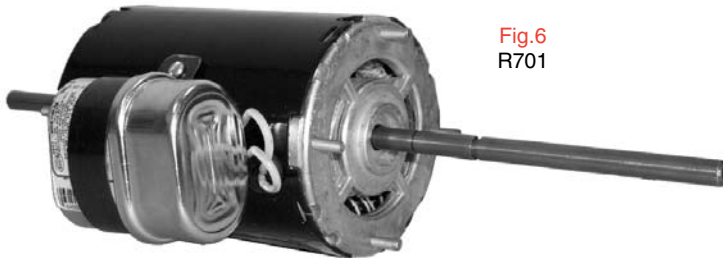

Fig.6
R701



Fig.7
R422
R438

115 & 230 Volt - Sleeve Bearing & Ball Bearing

Part #	Amps	H.P.	Volts	Rot.	Speed	Const.	Shaft	Body	Feature	Cap	Comment	Fig.
R371	0.38	1/20	230	C.W.	1/1550	OPEN	2.6"x5/16"	4.00	Plug, ball bearing	INC.	Keeprite	1
R370	0.75	1/20	115	C.W.	1/1550	OPEN	2.8"x5/16"	4.00	Plug, ball bearing	INC.	Keeprite	1
R373	0.90	1/15	115	C.C.W.	1/1400	T.E.	3.3"x3/8"	4.50	Plug	4/250	Greenhouse Fan	2
R499	1.00	1/15	115	C.C.W.	1/1625	OPEN	2.3"x5/16"	4.55	4studs front	4/370	Grainger 3M499B	3
R348	1.12	1/15	115	C.C.W.	2/1550	T.E.	3.4"x3/8"	4.1	3 ears	INC.	Vanee HRV M1703	4
R438	1.05	1/14	115	C.W.	2/1600	OPEN	1.5"x5/16"	4.25	3 Ears mtg.	4/370	Venmar HRV 01038	7
R462	1.10	1/17	115	C.C.W.	3/1660	OPEN	3.5"x3/8"x3.5"	4.00	2 studs side	7.5/370	Venmar HRV 02102	5
R312	1.20	1/12	115	C.C.W.	1/3250	OPEN	4.0"x5/16"	4.63	Internal Fan, ball bearing	4/370	Engineered Air 101322	3
R701	1.30	1/12	115	C.C.W.	3/1550	T.E.	5.0"x5/16"x2.7"	4.60	4 studs front & rear	INC.	Window A/C	6
R366	1.70	1/7	115	C.W.	3/1630	OPEN	3.0"x3/8"x3.0"	4.75	2 studs side	7.5/370	Venmar HRV 02100	5
R422	2.90	1/6	115	C.W.	3/1690	OPEN	2.1"x3/8"	4.90	3 ears	7.5/370	Venmar HRV 02209	7

Hubless - Totally Enclosed

Sleeve & Ball Bearing - Shaded Pole



Fig. 1
R101
R103
R121
R122
R125
R129
R133
R137
R1211



Fig. 2
R109
R124
R127
R128



Fig. 3
R101L
R103L
R114
R119
R120



Fig. 4
R108

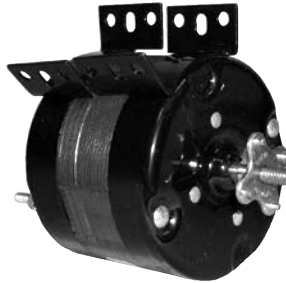

Fig. 5
R123



Fig. 6
R250

115 & 230 Volts

Part #	Amps.	H.P.	Spd/RPM	Voltage	Rotation	Body	Feature	Comment	Fig.
R1211	0.30	1/150	1/1550	115	C.W.	2.09	0.67" to hub face	5 Watt, Domestic Ref.	1
R128	0.35	1/135	1/1550	115	C.W.	2.09	3 Pt. Mtg., 3 Pin Plug	Coldstream	2
R121	0.35	1/60	1/1550	230	C.C.W.	2.50	3 pin Plug	Coldstream	1
R122	0.35	1/60	1/1550	230	C.W.	2.50	3 pin Plug	Foster, Coldstream	1
R114	0.45	1/125	1/1550	115	C.W.	2.09	Leads, 3 Point or Leg Mounting	General Replacement	3
R123	0.50	1/70	1/1550	115	C.W.	2.60	Two U brackets	Universal Cooler	5
R250	0.50	1/65	2/1500	115	C.C.W.	3.70	Two speed, Switch cord, plug	Selkirk	6
R109	0.55	1/135	1/1550	115	C.W.	2.00	2 Pin Plug	C.V.Hill	2
R108	0.55	1/95	1/1550	115	C.C.W.	2.00	One U Bracket, leads	Blanchard	4
R119	0.55	1/85	1/1550	115	C.C.W.	2.24	Leads, 3 Point or Leg Mounting	Foster	3
R120	0.55	1/85	1/1550	115	C.W.	2.24	Leads, 3 Point or Leg Mounting	Foster	3
R137	0.59	1/70	1/1550	115	C.W.	2.20	2 Pin Plug	Coldstream	1
R129	0.65	1/60	1/3000	115	C.C.W.	2.50	2 Pin plug	Hill Refrigeration	1
R127	0.75	1/80	1/1600	115	C.C.W.	2.09	Stud Mounting	Foster	2
R125	0.80	1/20	1/1500	230	C.C.W.	4.00	2 pin plug, Ball bearing	Dunham, Bush	1
R101	0.90	1/45	1/1550	115	C.W.	2.30	2 Pin Plug, Leg Mtg.	Hussman	1
R101L	0.90	1/45	1/1550	115	C.W.	2.30	2 Pin Plug	Hussman	3
R103	0.90	1/45	1/1550	115	C.C.W.	2.30	2 Pin Plug	Hussman	1
R103L	0.90	1/45	1/1550	115	C.C.W.	2.30	2 Pin Plug, Leg Mtg.	Hussman	3
R133	1.00	1/40	2/1550	115	C.C.W.	2.60	Two speed	Mark Hot	1
R124	1.55	1/20	1/1550	115	C.C.W.	4.00	2 pin plug, Ball bearing	Dunham Bush	2

Rotation determined opposite shaft end
Double shaft determined at lead end

Shaft length measured from hub
face to shaft end

Unit Bearing Motors



Totally Enclosed - 3.5" Diameter (51 Frame)

Domestic & Commercial Refrigeration

Motors



Fig.1

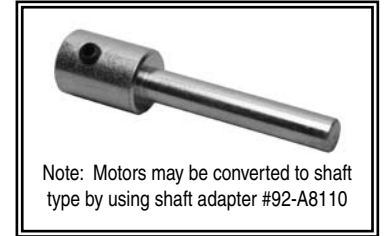

115 & 230 Volts 1550 & 1500 RPM

• Cast Iron (except R5109 & R1211)

Part #	Watts	Amps	Volts	Rot	RPM	A Dim	Shaft	Comment	Fig
R5090	2	0.25	115	C.W.	1550	2.70"	Hubless	CAST IRON 2 WATT CONDENSER MOTOR	1
R5109		0.25	115	C.W.	1550	2.50"	Hubless	GE 5109, WR60X77, 5KSM51AG3070, 5KSP51AZL826	1
R5211	4	0.35	115	C.W.	1550	2.58"	Hubless	TECUMSEH TFM41, G.E. 5211 5KSP51AL511	1
R5212		0.35	115	C.C.W.	1550	2.58"	Hubless	G.E. 5212, 5KSP51AL513	1
R5221		0.20	230	C.W.	1550	2.58"	Hubless	G.E. 5221, 5KSP51AL512, COPELAND 050-0246-00	1
R5222	5	0.20	230	C.C.W.	1550	2.58"	Hubless	G.E. 5222, 5KSP51AL514	1
R5911		0.35	115	C.W.	1550	3.30"	Hubless	COPELAND 050-0010-00,0178-00 050-0246-01,HILL PP7577	1
R6247		0.35	115	C.W.	1550	3.44"	Hubless	R CORNELIUS	1
R1211		0.30	115	C.W.	1550	2.09"	Hubless	3.3", 199D354HO1, H06, H13, WR60D1, 6550923, 6550928	1
R5311	6	0.50	115	C.W.	1550	2.83"	Hubless	G.E. 5311, 5KSP51CL501, TECUMSEH TFM61	1
R5312		0.50	115	C.C.W.	1550	2.83"	Hubless	5914767, 5914782, G.E. 5312, 5KSP51CL502	1
R6243		0.50	115	C.W.	1550	3.44"	Hubless	CORNELIUS	1
R5411	9	0.60	115	C.W.	1550	2.83"	Hubless	G.E. 5411, 5KSP51ECL551 TECUMSEH TFM91	1
R5412		0.60	115	C.C.W.	1550	3.40"	Hubless	G.E. 5412, 5KSP51ECL553	1
R5421	9	0.30	230	C.W.	1550	2.83"	Hubless	TECUMSEH TFM62, TFM92, G.E. 5421, 5KSP51ECL552	1
R5422		0.30	230	C.C.W.	1550	2.83"	Hubless	G.E. 5422, 5KSP51ECL554	1
R5611		0.60	115	C.W.	1550	3.07"	Hubless	HUSSMANN 47000, 58698	1
R5612	12	0.60	115	C.C.W.	1550	3.07"	Hubless	HUSSMANN 38360	1
R6273		0.60	115	C.W.	1550	3.13"	Hubless	CONDENSER MOTOR FOR CAN TYPE VENDING MACHINES	1
R5711	12	0.37	115	C.W.	1550	3.50"	Hubless	PSC, HUSSMAN, HILL & KYSOR 400603, P41661, 19A10-055,	1
R5715		0.37	115	C.W.	1550	3.50"	Hubless	PSC, TYLER & KYSOR 5215879, 5237801, 73049	1
R5720		0.37	115	REV.	1550	3.50"	Hubless	PSC, HUSSMAN, HILL, TYLER & KYSOR 411151, P23956, 5212930	1

Totally Enclosed - 3.5" Diameter (51 Frame)



Fig.1



Fig.2

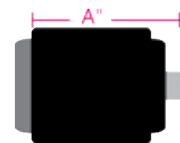
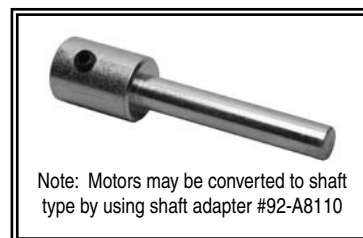

Fig.3



Part #	Watts	Amps	Volts	Rot	RPM	A Dim	Shaft	Comment	Fig
R5811	16	1.00	115	C.W.	1550	3.03"	Hubless	050-0164-00, 050-0247-00, 401-0032-01, G.E. 5811	1
R5812		1.00	115	C.C.W.	1550	3.03"	Hubless	G.E. 5812, 5KSP51GL583T	1
R5821		0.50	230	C.W.	1550	3.03"	Hubless	G.E. 5821, 5KSP51GL582T	1
R5822		0.50	230	C.C.W.	1550	3.03"	Hubless	G.E. 5822, 5KSP51GL584	1
R2011	23	0.80	115	C.W.	1500	3.75"	Hubless	HILL PP20934F	1
R2511	25	1.10	115	C.W.	1500	3.50"	Hubless	TECUMSEH TFM191, 810E019A73, 810E019A80	1
R2512		0.60	230	C.W.	1550	3.50"	Hubless	G.E. 0253	1
R2521		1.10	115	C.C.W.	1500	3.50"	Hubless	ESPL25EMR1, ESPL25EVRD1	1
R2522		0.60	230	C.C.W.	1500	3.50"	Hubless	ESPL25EMR2, ESPL25EVR2	1
R3511	35	1.40	115	C.W.	1500	3.50"	Hubless	TECUMSEH TFM351, HUSSMANN 328346, COPELAND 050-0227-01	1
R3512		0.70	230	C.W.	1500	3.50"	Hubless	TECUMSEH TFM 352, 810M35A12, 810M35A21, 810M35A28	1
R3521		1.40	115	C.C.W.	1500	3.50"	Hubless	G.E. 0352	1
R3522		0.70	230	C.C.W.	1500	3.50"	Hubless	EPPL35EM2B2C2, ESPL35EMR2	1
R3612		0.70	230	C.W.	1500	3.50"	1.4"x5/16"	TECUMSEH TFM262, TFM362, 810A108, 810E026A81	2
R5011	50	1.70	115	C.W.	1500	4.50"	1.5"x3/8"	COPELAND 050-0011-01,0017-02 050-0237-01, 998100800	3
R5012		0.85	230	C.W.	1500	4.50"	1.5"x3/8"	050-0017-01,03,0011-00, 0101-00,0237-00,998100700	3
R5021		1.70	115	C.C.W.	1500	4.50"	1.5"x3/8"	A0502, 259, ESPL05EMR1	3
R5022		0.85	230	C.C.W.	1500	4.50"	1.5"x3/8"	TECUMSEH 810A31B, 810G037A20	3
R5112		0.85	230	C.W.	1500	4.50"	1.4"x5/16"	TECUMSEH, 810M50A62	3
R5122		0.85	230	C.C.W.	1500	4.00"	2.0"x5/16"	TECUMSEH TFM502, 810G050A50	3

Unit Bearing Motors



Totally Enclosed - 3.5" Diameter (51 Frame)

EE Line of GE Replacements



- Unit Bearing
- CW Rotation
- 51 Frame
- Hubless Shaft
- Shaded Pole



Part #	Watts	Volts	Amps	Spd/RPM	Fig.	"A"	Shaft	Termination
EE-5211	4	115	0.29	1/1550	1	2.74"	1/4" x 20 Hubless	
EE-5311	6	115	0.40	1/1550	1	2.74"	1/4" x 20 Hubless	
EE-5610		115	0.40	1/1550	4	2.74"	1/4" x 20 Hubless	
EE-5411	9	115	0.52	1/1550	1	2.74"	1/4" x 20 Hubless	
EE-5611		115	0.52	1/1550	1	2.74"	1/4" x 20 Hubless	
EE-5412		115	0.55	1/1550	1	2.95"	1/4" x 20 Hubless	
EE-5421	16	230	0.27	1/1550	1	2.95"	1/4" x 20 Hubless	
EE-5811		115	0.90	1/1550	1	2.97"	1/4" x 20 Hubless	
EE-5812		115	1.00	1/1550	1	3.17"	1/4" x 20 Hubless	
EE-5821	25	230	0.50	1/1550	1	3.17"	1/4" x 20 Hubless	
EE-2511		115	1.10	1/1500	2	3.15"	1/4" x 20 Hubless	
EE-2512	35	208/230	0.55	1/1500	2	3.15"	1/4" x 20 Hubless	
EE-3511		115	1.40	1/1500	2	3.15"	1/4" x 20 Hubless	
EE-3512	50	208/230	0.70	1/1500	2	3.15"	1/4" x 20 Hubless	
EE-5011		115	1.70	1/1500	3	3.52"	3/8" x 1.5"	
EE-5012		208/230	0.85	1/1500	3	3.52"	3/8" x 1.5"	
EE-5112		208/230	0.85	1/1500	3	3.52"	5/16" x 1.5"	

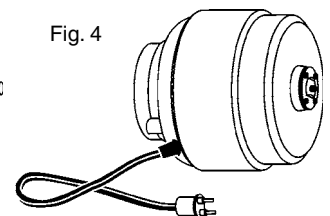
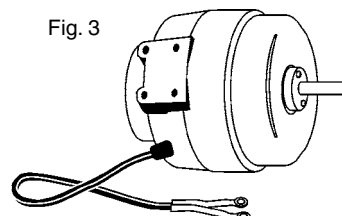
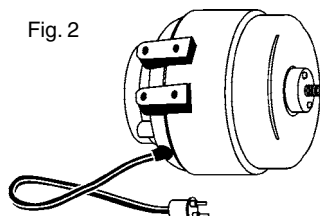
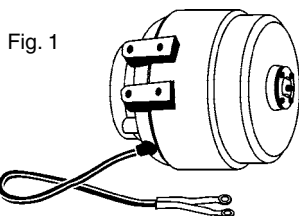

Totally Enclosed - Shaded Pole - 115, 230 Volts

Features

- Shaded pole
- 4 Pole
- Totally Enclosed
- 50/60 Hz
- Long Life Lubricated Sintec Sleeve-Bearings
- Duty: Continuous Air-over. Operation: All Angle
- Rotation: CW Opposite Shaft End
- Cord: 21"/23" Lead Length With #10 Ring Studs
- Mounting: 1 Foot, Front Shroud, Tapped Rear 3-Hole
- Included: Nuts, Screws & Fan Blade Adapter



SLEEVE BEARING

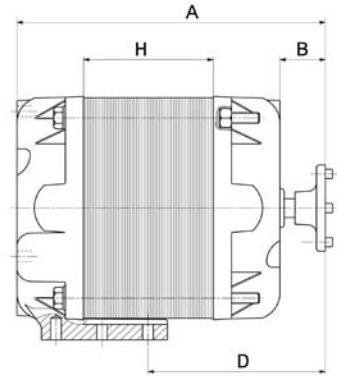

ELCO Motors

Part #	Watts	HP	RPM	Volts	Amps	Prot.	Dimensions: mm (")			
							H	A	B	D
EC-4W115	4	1/185	1550	115	0.36	Imp.	13 (.51")	71.5 (2.82")	12.5 (.49")	42 (1.65")
EC-4W230		1/185	1550	230	0.18	Imp.	13 (.51")	71.5 (2.82")	12.5 (.49")	42 (1.65")
EC-5W115	5	1/150	1550	115	0.40	TH.	13 (.51")	71.5 (2.82")	12.5 (.49")	42 (1.65")
EC-5W230		1/150	1550	230	0.20	TH.	13 (.51")	71.5 (2.82")	12.5 (.49")	42 (1.65")
EC-6W115	6	1/125	1550	115	0.41	Imp.	20 (.79")	77.5 (3.05")	12.5 (.49")	48 (1.89")
EC-6W230		1/125	1550	230	0.20	Imp.	20 (.79")	77.5 (3.05")	12.5 (.49")	48 (1.89")
EC-9W115	9	1/83	1550	115	0.58	TH.	20 (.79")	77.5 (3.05")	12.5 (.49")	48 (1.89")
EC-9W230		1/83	1550	230	0.35	TH.	20 (.79")	77.5 (3.05")	12.5 (.49")	48 (1.89")
EC-16W115	16	1/47	1550	115	1.0	TH.	30 (1.18")	91.5 (3.6")	16 (.63")	62 (2.44")
EC-16W230		1/47	1550	230	0.5	TH.	30 (1.18")	91.5 (3.6")	16 (.63")	62 (2.44")
EC-25W115	25	1/30	1550	115	1.5	TH.	45 (1.77")	106.5 (4.19")	15.5 (.61")	61 (2.4")
EC-25W230		1/30	1550	230	0.75	TH.	45 (1.77")	106.5 (4.19")	15.5 (.61")	61 (2.4")
EC-34W115	34	1/20	1550	115	1.6	TH.	45 (1.77")	106.5 (4.19")	15.5 (.61")	61 (2.4")
EC-34W230		1/20	1550	230	0.8	TH.	45 (1.77")	106.5 (4.19")	15.5 (.61")	61 (2.4")

ELCO Fan Blades

Part #	Motor	Diameter: mm (")	Pitch	Blades	Application	Construction
EC-4VEA012	4 & 5 W	154 (6.06")	28°	5	Suction	Plastic
EC-4012309		154 (6.06")	19°	5	Suction	Aluminum
EC-4012543		172 (6.77")	28°	5	Blower	Aluminum
EC-4VEA009	6 & 9 W	200 (7.87")	28°	5	Suction	Plastic
EC-4VEA010		200 (7.87")	34°	5	Suction	Plastic
EC-4VEA013		230 (9.05")	25°	5	Suction	Plastic
EC-4VEA006	16 W	230 (9.05")	31°	5	Suction	Plastic
EC-4VEA007		254 (10.0")	28°	5	Suction	Plastic

ELCO Fan Guards

Notes: Imp. = Impedance. - TH. = Thermal Protection

Part #	Description
EC-1055223	Plastic, 7.87" Dia.
EC-1055224	Plastic, 10" Dia.
EC-1055318	Metal, 9.05" Dia
EC-1055303	Metal, 10" Dia.

ELCO Brackets

Part #	Description
EC-EUBKT01	Bracket for US style Elco Motors

Rotation determined opposite shaft end
Double shaft determined at lead end

Shaft length measured from hub
face to shaft end

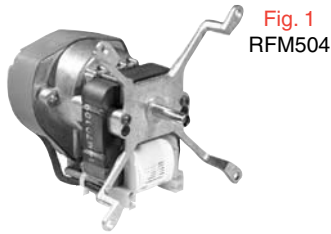

Fig. 1
RFM504



Fig. 2
RFM461



Fig. 3
RFM2
RFM10



Fig. 4
RFM1198



Fig. 5
RFM890



Fig. 6
RFM3
RFM4
RFM5
RFM653



Fig. 7
RFM580



Fig. 8
RFM11

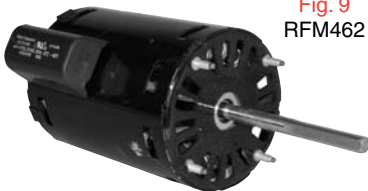

Fig. 9
RFM462



Fig. 10
RFM680



Fig. 11
RFM12

Part #	HP	Spd/RPM	Amps	Volts	Rot	Shaft	Body	Type	Mntg	Comment	Fig
RFM504	1/200	1/3000	0.25	208/230	C.C.W.	0.8"x1/4"	4.90	S.P.	4 LEG	KEEPRITE 504015K	1
RFM461	1/40	1/3200	0.37	460	C.C.W.	2.5"x1/4"	5.80	S.P.	4 STUD	YORK 024-24115-019B 56" LEADS	2
RFM2	1/35	1/3000	1.30	115/230	C.C.W.	3.9"x5/16"	4.90	S.P.	2 STUD	FRANKLIN 80137, FASCO D406, D408	3
RFM10	1/35	1/3000	1.30	115/230	C.W.	3.9"x5/16"	4.90	S.P.	2 STUD	E.J. WALSH 8211910172, FEDDERS,W/CENTRIFUGAL SWITCH	3
RFM1198	1/30	1/3200	1.50	115	C.W.	2.3"x5/16"	3.40	S.P.	LUGS	LENNOX 25J1201	4
RFM890	1/25	1/3200	0.70	208/230	CCW	2.3"x5/16"	3.29	S.P.	STUD	LENNOX 98G8901, 7121-7091	5
RFM5	1/20	1/3000	1.80	115/230	C.C.W.	2.3"x1/4"	5.30	S.P.	4 STUD	FEDDERS S1900047003, U.E. 570	6
RFM4	1/20	1/3000	1.80	115/230	C.W.	2.3"x1/4"	5.30	S.P.	4 STUD	CARRIER HC24AU700, U.E. 571	6
RFM580*	1/20	1/3300	1.90	115	C.C.W.	1.9"x5/16"	3.50	S.P.	LUGS	HC27VE120, UNIV. JA1P053N, BRYANT P251-2307, U.E. 580	7
RFM11*	1/20	1/3200	1.80	115	C.C.W.	1.5"x5/16"	3.60	S.P.	3 LUGS	CLARE BROS. M045	8
RFM653	1/20	1/3430	1.00	230/460	C.W.	2.1"x1/4"	5.90	S.P.	4 STUD	CARRIER, YORK, KEEPRITE U653 FASCO 7131-0506, 5/16 BUSHING	6
RFM462	1/16	1/3450	0.30	460	C.W.	3.3"x5/16"	4.80	P.S.C. /INC	4 STUD	ICP 1171347 CARRIER HC30GB460	9
RFM680	1/16	1/3450	1.00	115/208 /230	REV. PLUG	1.2"x1/4"	7.00	P.S.C. /INC	4 STUD	YORK 024-24115-001,701, CARRIER HC680001B, W/SWITCH	10
RFM3	1/16	1/3400	1.20	230/460	C.C.W.	2.3"x1/4"	6.20	S.P.	4 STUD	CARRIER, YORK, U660 W/CENT.SWITCH 5/16 BUSHING	6
RFM12*	1/15	1/3000	2.00	115	C.C.W.	1.3"x5/16"	4.40	S.P.	3 LUGS	M046 - CLARE HIGH EFFICIENCY	11

* Note: Without Centrifugal Switch



Fig. 1
RFM230



Fig. 2
RFM9



Fig. 3
RFM232

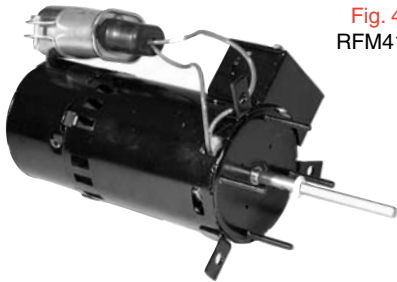

Fig. 4
RFM410

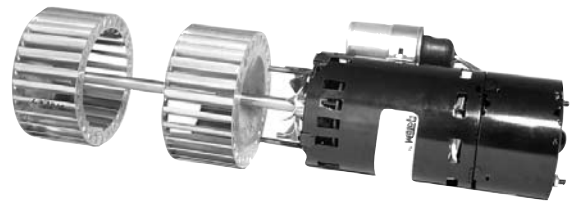

Fig. 5
RFM187



Fig. 6
RFM460

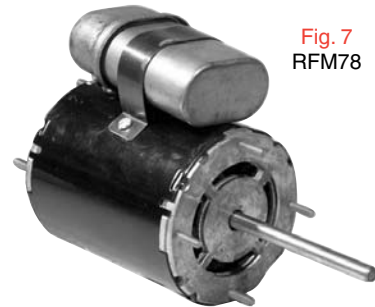

Fig. 7
RFM78

Part #	HP	Spd/RPM	Amps	Volts	Rot	Shaft	Body	Type	Mntg	Comment	Fig
RFM230	1/12	1/3200	0.60	230	REV. PLUG	2.5"x1/4"	7.00	P.S.C. /INC	STUD	024-24115-020, 714	1
RFM9	1/12	1/3000	1.10	208/230	C.C.W.	2.8"x5/16"	6.30	S.P.	STUD	KEEPRITE 501493,	2
RFM232	1/10	1/3450	0.55	208/230	C.W.	2.9"x5/16"	5.00	P.S.C. /INC	STUD	ICP 1171348, JF1H092N CARRIER HC30GB232	3
RFM410	1/10	1/3000	1.50	115/230	REV.	3.7"x1/4"	7.10	P.S.C. /INC	LUGS	FASCO D410, D412, REZNOR	4
RFM187	1/10	1/3400	0.30	460	C.W.	8.8"x3/8"	6.80	P.S.C. /INC	STUD	YORK 024-2500-5005, 024-2500-5702, D1187	5
RFM460	1/10	1/3200	0.30	460	REV.	2.5"x1/4"	7.00	P.S.C. /INC	STUD	YVFM450, FASCO D1171 YORK 024-24115-700	6
RFM78	1/9	1/3200	1.30	115/230	REV.	3.3"x5/16"	4.10	P.S.C. /INC	STUD	RFM7&8, REZNOR 43846-115V, 43424-208/230V	7

* Note: Without Centrifugal Switch

4.1" Motors



115, 208/230 volt - 1550 RPM

Sleeve Bearing - Shaded Pole & P.S.C - Single & Double Shaft.



Fig.1
R2609
R2612
R2603
R2602

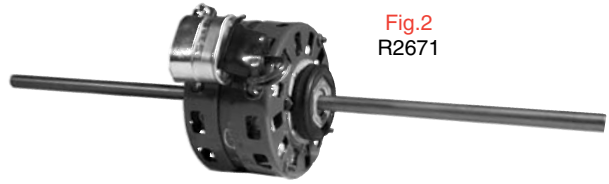

Fig.2
R2671



Fig.3
R2657
R2658



Fig.4
R2614

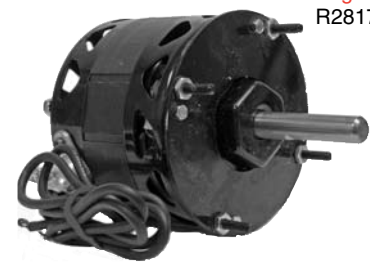

Fig.5
R2817



Fig.6
R2811



Fig.7
R731



Fig.8
R2604

Part #	HP	Amps	Volts	Spd/RPM	Rot.	Shaft	Body	Comment	Encl.	Fig.
R2609	1/30	1.21	115	1/1550	C.W.	2.4"x1/2"	3.00"	UE 009, FRANKLIN 75009, INTERCITY c/w CONDUIT BOX	T.E.	2
R2612	1/30	1.21	115	1/1550	C.C.W.	2.4"x1/2"	3.00"	UE 010, INTERCITY c/w CONDUIT BOX	T.E.	3
R2602	1/23	1.30	115	1/1550	C.C.W.	2.2"x1/2"	3.08"	REVERSOMATIC	OPEN	1
R2603	1/23	1.30	115	1/1550	C.W.	2.2"x1/2"	3.08"	REVERSOMATIC DK260 - DB200, (268 CFM), FRANKLIN 75003	OPEN	1
R2817	1/20	1.60	115	1/1550	C.C.W.	2.8"x1/2"	3.10"	KEEPRITE 28175, FASCO 7108-2217, 7108-7027	OPEN	1
R2811	1/20	2.10	115	1/1050	C.C.W.	2.5"x1/2"	2.60"	FASCO 7151-2253, KEEPRITE 28110	OPEN	4
R2657	1/15	1.20	230	1/1550	C.W.	2.4"x3/8"	3.40"	KEEPRITE 81335	OPEN	5
R2658	1/15	2.30	115	1/1550	C.W.	1.8"x3/8"	3.40"	KEEPRITE 81356	OPEN	6
R731	1/15	2.35	115	2/1550	C.C.W.	2.3"x3/8"x2.3"	3.10"	122958, 123655, 170621, 71108, 90013, 90248, 96962, SM703	OPEN	4
R2614	1/12	2.25	115	1/1550	C.C.W.	2.5"x3/8"	4.00"	DELHI FAN MOTOR	OPEN	3
R2671	1/10	0.60	208/230	3/1610	C.C.W.	9.4"x1/2"x9.3"	3.09"	CHROMALOX INCREMENTAL 807-101, UE DE2E106N Cap Inc.	OPEN	7
R2604	1/10	2.65	115	1/1550	C.W.	2.2"x1/2"	3.65"	REVERSOMATIC DB300	OPEN	8

Single Shaft-115 Volts - Open & Totally Enclosed

Sleeve Bearing - Shaded Pole & P.S.C.



Fig.1
R2197

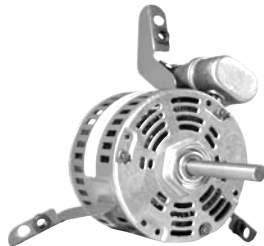

Fig.2
R2195
R2194



Fig.3
R2198
R2654

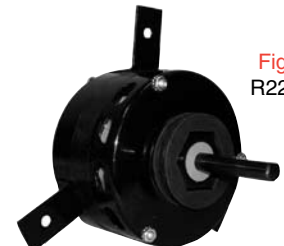

Fig.4
R2269



Fig.5
R6920

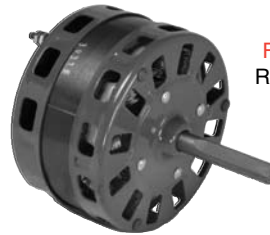

Fig.6
R2343



Fig.7
R2653



Fig.8
R2698



Fig.9
R2930
R2932
R2940
R2942
R2360



Fig.10
R2980

Part #	HP	Amps	Spd/RPM	Rot.	Shaft	Body	Encl.	Type	Comment	Fig.
R2360	1/15	1.70	1/1050	C.C.W.	2.8"×1/2"	3.59	T.E	S.P.	REZNOR 45330, 45331, 54332, FASCO D143, U.E. 360	9
R2269	1/15	2.40	1/1050	C.C.W.	3.0"×1/2"	3.00	OPEN	S.P.	KEEPRITE 160269, FASCO 7151-2850, 7151-3862	4
R6920	1/15	2.40	1/1050	C.C.W.	3.0"×3/8"	3.80	T.E.	S.P.	KEEPRITE, INTERCITY, LENNO× P8-6920	5
R2197	1/14	1.20	3/820	C.C.W.	3.4"×1/2"	3.80	OPEN	7.5/370	TEMSPEC DE3E142N	1
R2194	1/14	1.25	3/820	C.C.W.	3.4"×1/2"	3.22	OPEN	7.5/370 INC.	TEMSPEC DE3E141N	2
R2198	1/14	1.25	3/820	C.C.W.	4.1"×1/2"	3.22	OPEN	7.5/370	TEMSPEC DE3E142N	3
R2195	1/12	2.10	3/740	C.C.W.	4.0"×1/2"	3.60	OPEN	7.5/370 INC.	TEMSPEC DE3F056N	2
R2653	1/12	2.90	3/1050	C.W.	1.6"×1/2"	3.40	OPEN	S.P.	GENERAL REPLACEMENT	7
R2654	1/12	3.10	3/1050	C.C.W.	2.5"×1/2"	2.65	OPEN	S.P.	G.E. 5KSP29D×1906, FASCO D1054	4
R2930	1/10	4.00	1/1050	C.W.	2.3"×3/8"	4.80	OPEN	S.P.	G.E. 2121, 2122, 2223, 2321,,2322 Dual Voltage	9
R2932	1/10	4.00	1/1550	C.C.W.	2.3"×3/8"	4.80	OPEN	S.P.	G.E. 2131, 2132, 2231,2232, 2331, 2332, Dual Voltage	9
R2940	1/10	4.00	1/1050	C.W.	2.3"×3/8"	4.80	OPEN	S.P.	G.E. 2113, 2213, 2311,,2312, Dual Voltage	9
R2942	1/10	4.00	1/1550	C.W.	2.8"×3/8"	4.56	OPEN	S.P.	G.E. 2141, 2142, 2241,2242, 2341, 2342, Dual Voltage	9
R2980	1/10	3.20	3/1050	C.C.W.	3.3"×3/8"	3.80	S.E.	S.P.	GENERAL REPLACEMENT	10
R2698	1/10	3.50	1/1050	C.C.W.	2.1"×1/2"	3.00	OPEN	S.P.	BROAN A0520B2298, 30080126, 30080135	8

Motors continued next page

Rotation determined opposite shaft end
Double shaft determined at lead end

Shaft length measured from hub
face to shaft end

5.0" Motors



Single Shaft-115 Volts - Open & Totally Enclosed

Sleeve Bearing - Shaded Pole & P.S.C.



Fig.1
R2393
DD-029
R2196



Fig.2
R2398
R2387
R2617
R2395



Fig.3
R2368



Fig.4
R2379
R2386
R2343

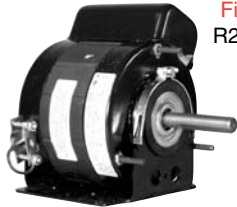

Fig.5
R2380



Fig.6
R2679
R2348
R2385
R2626



Fig.7
R2326
R2627
R2390



Fig.8
R2615



Fig.9
R2680

Motors continued from previous

Part #	HP	Amps	Spd/RPM	Rot.	Shaft	Body	Encl.	Type	Comment	Fig.
R2343	1/9	3.80	1/1050	C.C.W.	3.0"x1/2"	2.90	OPEN	S.P.	BROAN 1094343	4
DD-029	1/8	2.10	5/1000	REV.	5.0"x1/2"	3.61	OPEN	INC	UE-799, L350, L450, L600, DA3E200, DA3G142, R2299 INTERCITY UFE90, UFG110,130,UFG150,300, REZNOR 45882,8	1
R2615	1/8	2.60	1/1050	C.C.W.	3.1"x1/2"	4.10	T.E.	S.P.	REZNOR 170-45888,55681,9775,U.E. 380, FASCO D260	8
R2380	1/8	2.60	1/1075	C.C.W.	2.2"x1/2"	3.90	T.E.	INC.	REZNOR 170-45888,55681,9775,U.E. 380, FASCO D260	5
R2196	1/8	2.50	3/850	C.C.W.	3.9"x1/2"	4.00	OPEN	7.5/370 INC.	DE3G110N	2
R2386	1/8	5.00	2/1050	C.C.W.	3.8"x1/2"	3.90	OPEN	S.P.	U.E. 346, FASCO D180,COLEMAN	4
R2398	1/8	5.00	3/1050	C.C.W.	3.8"x1/2"	3.90	OPEN	S.P.	FASCO D178, D356,U.E. 98	2
R2617	1/8	5.20	1/1050	C.C.W.	5.5"x1/2"	3.30	OPEN	S.P.	U.E. 467, FASCO D1032,D247, D258	2
R2326	1/7	4.70	1/1050	C.C.W.	3.4"x1/2"	3.30	OPEN	S.P.	U.E. 326	7
R2348	1/6	5.50	4/1050	C.C.W.	4.5"x1/2"	3.80	OPEN	S.P.	FASCO D164	6
R2390	1/5	3.20	3/1075	REV.	5.5"x1/2"	3.90	OPEN	7.5/370	U.E.390, YORK 24-22489-000,BOHN 5002L, 5003F	7
R2368	1/5	3.50	4/1030	C.C.W.	3.9"x1/2"	4.07	OPEN	4/370	1268,024-17903-703,HC37MA135,P8 -3789,90,3527,29,4662,9662	3
R2385	1/5	5.50	3/1050	C.C.W.	5.5"x1/2"	4.00	OPEN	S.P.	U.E. 385, 90, FASCO D158	6
R2393	1/5	6.00	1/1050	C.C.W.	5.8"x1/2"	3.80	OPEN	S.P.	MILLER FURNACE OML6433	1
R2627	1/5	6.00	1/1050	C.C.W.	5.5"x1/2"	3.30	OPEN	S.P.	FASCO D240,	7
R2626	1/5	7.10	4/1050	C.C.W.	2.6"x1/2"	3.90	OPEN	S.P.	319P327, 368, 375, 477, 478,319P705, 892, 322P083, 582	6
R2387	1/5	7.80	4/1050	C.C.W.	4.8"x1/2"	4.10	OPEN	S.P.	CARRIER HC37MA134,HC37MA138,05-1049, 05-1051, 05-1054	2
R2395	1/4	3.10	3/1075	REV.	3.1"x1/2"	4.10	OPEN	5/370	FASCO D150	2
R2680	1/4	3.50	3/1050	C.C.W.	2.8"x1/2"	3.69	OPEN	15/370	FASCO D289	9
R2379	1/4	6.10	3/1075	C.C.W.	2.5"x1/2"	4.10	OPEN	10/370	024-17903-005, KCP29KK451BT	4
R2679	1/4	10.00	3/1050	C.C.W.	2.2"x1/2"	4.00	OPEN	S.P.	LENNOX, YORK, CARRIER	6

Double Shaft - 115 Volts - Open & Totally Enclosed

Sleeve Bearing - Shaded Pole & P.S.C.

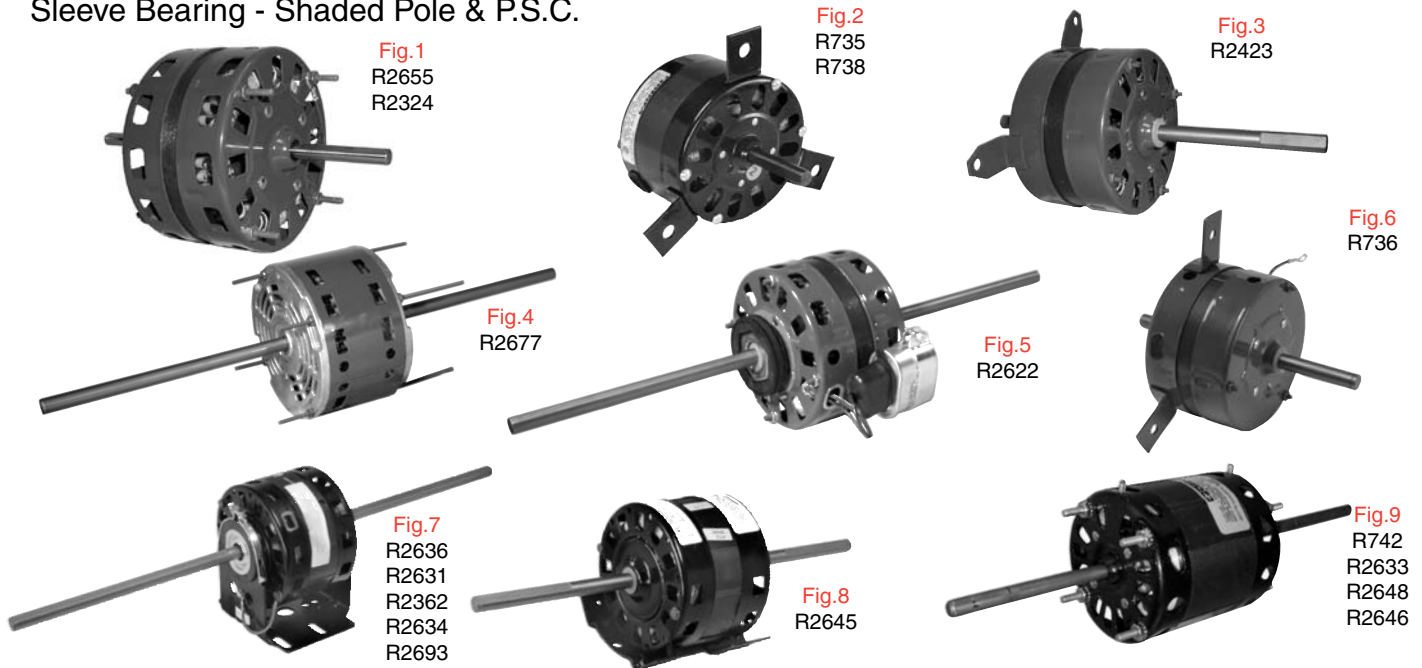

Part #	HP	Amps	Spd/RPM	Rot.	Shaft	Body	Encl.	Type	Cross Reference	Fig
R2655	1/12	1.10	1/1550	C.C.W.	2.9"x1/2"x2.8"	3.00	OPEN	5/370	NUTECH-LIFEBREATH,A0812B2355	1
R735	1/12	1.10	2/1165	C.W.	2.4"x1/2"x5.0"	3.60	OPEN	10/370	KEEPRITE 200063	2
R736	1/12	1.30	3/1080	C.C.W.	1.9"x1/2"x2.7"	3.50	T.E.	4/370	130184, SM701, SM715, SM706,SM716,SM721	6
R2324	1/12	1.40	1/1550	C.C.W.	2.9"x3/8"x2.6"	3.75	OPEN	INC	23-204, 5KCP298G8560BS, 7185-0242	3
R742	1/10	1.35	3/1080	C.C.W.	3.5"x1/2"x4.0"	3.30	OPEN	4/370	CAMCO WJ94X316	9
R2631	1/10	1.50	3/1625	C.C.W.	9.3"x1/2"x9.3"	3.50	OPEN	5/370	U.E.382, CAMCO WJ94X314,	7
R738	1/10	1.50	3/1330	C.W.	2.4"x1/2"x5.0"	3.50	OPEN	7.5/370	SM702, 707, 712, WJ94M124,71926, 89812, 98007, 98066	2
R2362	1/10	1.70	4/1075	C.C.W.	10.3"x1/2"x10.9"	3.30	OPEN	INC	U.E. 362, FASCO D253, D291	7
R2634	1/10	3.20	5/1050	C.C.W.	10.6"x1/2"x10.6"	3.50	OPEN	S.P.	U.E. 89, FASCO D256, D289,D1010, D1014	7
R2693	1/10	3.20	5/1050	C.C.W.	8.0"x3/8"x8.0"	4.50	OPEN	S.P.	U.E.93, 452, 293, FASCO D293, GE 2093	7
R2633	1/10	3.50	3/1550	C.C.W.	7.5"x1/2"x7.5"	3.30	OPEN	S.P.	U.E.420, FASCO D236,	9
R2636	1/10	3.50	3/1550	C.C.W.	9.3"x1/2"x9.3"	3.30	OPEN	S.P.	WJ94M120, 122, 123,WJ94M127, 129, 130	7
R2423	1/8	1.80	3/1330	C.W.	2.0"x1/2"x5.0"	3.40	OPEN	10/370	KEEPRITE, ELECTROHOME,200423	3
R2622	1/6	3.20	4/1550	REV. PLUG	8.2"x1/2"x8.1"	3.34	OPEN	5/370 INC.	AMERICAN AIR FILTER,HEAT PUMP 7184-0354	5
R2648	1/6	4.00	4/1550	C.C.W.	7.3"x1/2"x7.3"	3.80	OPEN	S.P.	U.E.407, FASCO D338	9
R2677	1/5	2.80	3/1625	C.C.W.	8.4"x1/2"x8.5"	3.50	OPEN	5/370	7124-0103	4
R2645	1/4	3.10	2/1625	C.W.	5.7"x1/2"x5.7"	3.60	S.E.	7.5/370	WESTINGHOUSE 322P708,COLEMAN	8
R2646	1/4	5.60	3/1050	C.C.W.	10.0"x1/2"x10.0"	4.00	OPEN	7.5/370	GENERAL REPLACEMENT	9

5.0" Motors



Single Shaft - 115/208/230, 208/230, 230 Volts

Sleeve Bearing - Shaded Pole-PSC



Fig.1
R2639
R2928
R2929



Fig.2
R1050
R2375

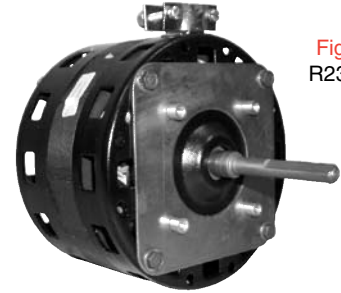

Fig.3
R2372



Fig.4
R2691
R2930
R2932
R2940
R2942
R2391
R2388
R2429

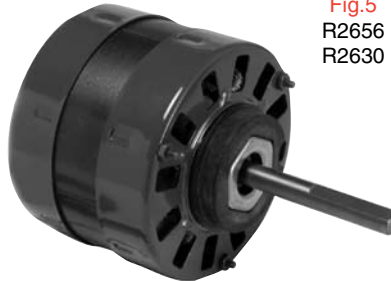

Fig.5
R2656
R2630

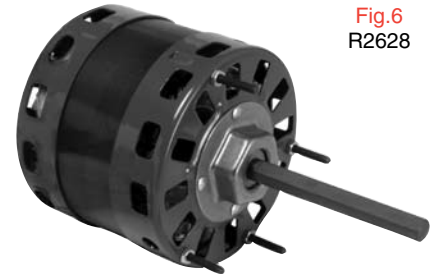

Fig.6
R2628

Part #	HP	Amps	Volts	Spd/RPM	Rot.	Shaft	Body	Encl.	Type	Cross Reference	Fig.
R2639	1/20	0.42	208/240	2/1075	C.W.	1.5"x1/2"	3.30	OPEN	3/370	CHROMALOX INCREMENTAL,01103-100, UE CE3E001N	1
R2375	1/20	1.00	230	1/1000	C.W.	2.5"x1/2"	3.00	OPEN	S.P.	AMERICAN AIR FILTER #141	2
R2372	1/20	1.10	230	1/1500	C.W.	2.8"x5/16"	3.10	OPEN	S.P.	TECUMSEH TFM372,8105037B01, 326P137	3
R2928	1/12	0.50	208/240	3/1000	C.C.W.	2.5"x1/2"	3.00	OPEN	3/370	CHROMALOX INCREMENTAL,01103-202, UE DE3D427N	1
R2930	1/10	4.00	115/208/230	1/1050	C.W.	2.3"x3/8"	4.80	OPEN	S.P.	G.E. 2121, 2122, 2223, 2321, 2322	4
R2932	1/10	4.00	115/208/230	1/1550	C.C.W.	2.3"x3/8"	4.80	OPEN	S.P.	G.E. 2131, 2132, 2231,2232, 2331, 2332	4
R2940	1/10	4.00	115/208/230	1/1050	C.W.	2.3"x3/8"	4.80	OPEN	S.P.	G.E. 2113, 2213, 2311, 2312	4
R2942	1/10	4.00	115/208/230	1/1550	C.W.	2.8"x3/8"	4.56	OPEN	S.P.	G.E. 2141, 2142, 2241,2242, 2341, 2342	4
R1050	1/8	0.90	208/240	1/1550	C.C.W.	3.0"x1/2"	3.30	T.E.	INC.	TRANE WW94X236, WW94X237,WW94X936,U.E.492, FASCO D1050	2
R2656	1/8	2.10	230	1/1050	C.C.W.	3.8"x1/2"	3.80	OPEN	S.P.	DA2F080 D316 D656 319P878,322P240 UE598	5
R2391	1/5	1.30	208/230	3/1075	REV	5.5"x1/2"	3.90	OPEN	7.5/370	FASCO D262, D1016,U.E. 391, 515	4
R2388	1/5	1.50	208/230	1/1075	REV	4.1"x1/2"	3.62	OPEN	5/370	WESTINGHOUSE 322P757	4
R2691	1/5	1.50	208/230	1/1075	C.W.	3.3"x1/2"	4.00	S.E.	5/370	MAGIC CHEF,CJK15,18,24,30,36, ARMSTRONG 35035B001, UE 691	4
R2429	1/5	3.10	208/230	3/1050	C.C.W.	5.5"x1/2"	3.90	OPEN	S.P.	U.E. 429, FASCO D318	4
R2628	1/4	1.40	208/230	3/1075	REV	4.5"x1/2"	4.10	OPEN	5/370	FASCO D151	6
R2929	1/4	1.30	208/240	1/1050	C.W.	2.0"x1/2"	3.30	OPEN	4/370	CHROMALOX INCREMENTAL,01103-201, UE DE3E102N	1
R2630	1/3	2.40	208/230	2/1400	C.W.	5.0"x1/2"	4.10	OPEN	6/370	WESTINGHOUSE 322P532,322P612, 322P798	5

Double Shaft - 208/230 Volts - Open & Totally Enclosed

Sleeve Bearing - Shaded Pole & P.S.C.

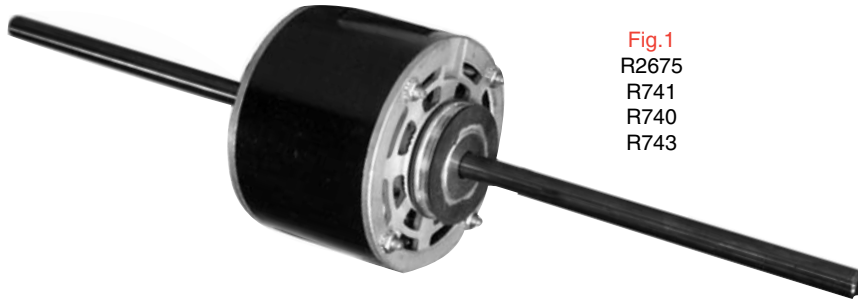

Fig.1
R2675
R741
R740
R743



Fig.2
R745

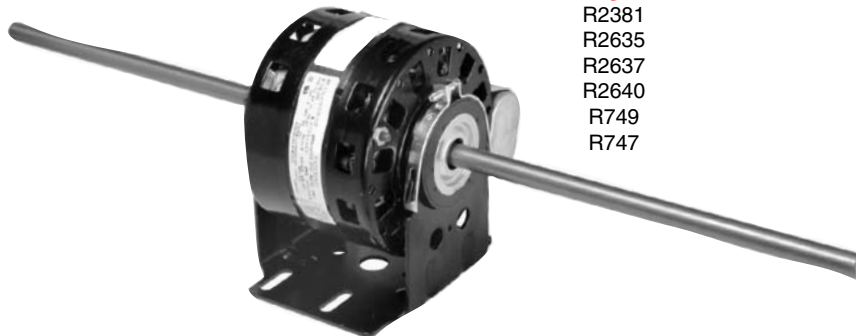

Fig.3
R2381
R2635
R2637
R2640
R749
R747

Part #	HP	Amps	Spd/ RPM	Rot.	Shaft	Body	Encl.	Type	Cross Reference	Fig.
R2675	1/30	0.30	4/1075	C.C.W.	8.5"x1/2"x8.5"	3.00	OPEN	2/370	AMERICAN AIR FILTER-SINGER, CLIMATE CONTROL 02024224	1
R2381	1/10	0.70	4/1075	C.C.W.	11"x1/2"x11"	3.38	OPEN	5/370	FASCO D1013, D292, D655, U.E. 381, FEDDERS D196186	3
R2635	1/10	1.60	4/1050	C.C.W.	9.3"x1/2"x9.3"	3.50	OPEN	S.P.	U.E. 320, FASCO D1015	3
R2637	1/10	1.80	3/1550	C.C.W.	10.4"x1/2"x10.4"	3.50	OPEN	S.P.	G.E. 5KSP29FK1543S, YORK 26-17384-000	3
R740	1/6	2.24	2/1050	C.C.W.	2.3"x1/2"x4.0"	3.12	OPEN	S.P.	S19600161003, S19600161016, U.E.523	1
R741	1/5	1.40	1/1075	C.W.	6.0"x1/2"x6.0"	3.90	OPEN	5/370	U.E.466, WESTINGHOUSE, 322P054,055,272,539,729	1
R2640	1/5	1.50	3/1500	C.C.W.	9.5"x1/2"x9.5"	3.30	OPEN	5/370	WESTINGHOUSE 322P533	3
R743	1/5	1.60	3/1400	C.C.W.	3.5"x1/2"x4.0"	3.90	OPEN		FASCO D1033	1
R745	1/4	1.90	2/1330	C.C.W.	1.8"x1/2"x2.8"	3.40	T.E.	5/370	CAMCO C275399, WJ94M116	2
R749	1/4	2.00	3/1075	C.C.W.	8.5"x1/2"x8.5"	4.81	OPEN	7.5/370	GEN. REPLACEMENT	3
R747	1/3	2.30	1/1625	C.C.W.	7.2"x1/2"x7.2"	4.00	OPEN	6/370	YORK 24-22492-000, WESTINGHOUSE 350A103H16	3

5.5" Motors



Single Shaft-115 Volts

Sleeve & Ball Bearing - Shaded Pole - PSC - Open & Totally Enclosed

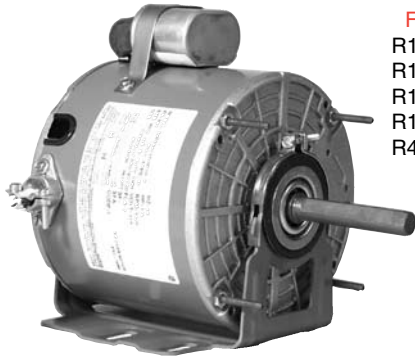

Fig.1
R12835
R12178
R12834
R12177
R42819

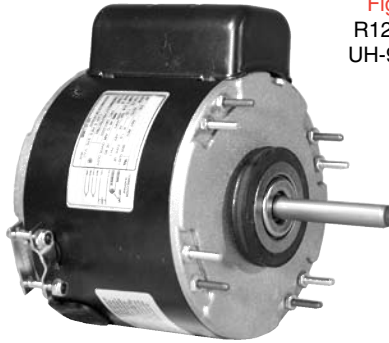

Fig.2
R12677
UH-9034

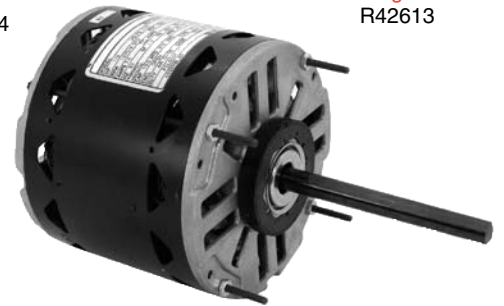

Fig.3
R42613



Fig.4
R42813
R42811



Fig.5
DD-030

Motors continued from previous

Part #	HP	Amps	Spd/RPM	Rot.	Body	Shaft	Type	Encl.	Bearing	Comment	Fig.
R42819	1/8	2.20	1/700	C.W.	6.50	1.5"x1/2"	5/370	OPEN	SLEEVE	G.E.3134, 5KCP36KG246,5KCP38NG208, 5KCP39KGB909	1
R42813	1/8	2.40	3/1050	C.C.W.	4.00	4.8"x1/2"	INC.	OPEN	SLEEVE	CARRIER HC35ME104	4
R42811	1/8	2.50	1/1050	C.C.W.	4.00	4.8"x1/2"	INC.	OPEN	SLEEVE	DUNHAM BUSH E310025	4
UH-9034	1/6	2.40	1/1075	REV	4.55	3.4"x1/2"	INC	T.E.	BALL	UH1016, US1016, NB, 9034, D834, 3206, X032, X306, 177, 749	2
DD-030	1/6	2.60	5/950	C.C.W.	3.98	4.4"x1/2"	INC	OPEN	SLEEVE	UNILUX 5KCP39DEV2795	5
R12835	1/6	2.00	1/1625	REV.PLUG	4.75	2.8"x1/2"	INC.	T.E.	BALL	GEN. REPLACEMENT	1
R12178	1/6	2.00	1/1625	REV.PLUG	5.25	2.8"x1/2"	INC.	T.E.	SLEEVE	GEN. REPLACEMENT	1
R12834	1/6	2.20	1/1075	REV.PLUG	4.36	2.5"x1/2"	INC.	T.E.	BALL	MARATHON X306	1
R12677	1/6	2.80	1/1075	REV	4.36	2.5"x1/2"	5/370	T.E.	SLEEVE	UNIT HEATER	2
R42613	1/6	3.00	3/1050	REV.PLUG	3.60	5.2"x1/2"	7.5/370	OPEN	SLEEVE	FRANKLIN 73192, 80192,G.E. 3920, 3980	3
R12177	1/6	3.00	1/1075	REV.PLUG	4.80	2.8"x1/2"	INC.	T.E.	SLEEVE	FASCO D834,FRANKLIN 74002, MARATHON X302, U.E. 177	1

Continued Next Page

Single Shaft - 115 Volts

Sleeve & Ball Bearing - PSC - Open & Totally Enclosed



Fig.1
R42416



Fig.2
R12486
R12586



Fig.3
DD-034
R42034
R42419

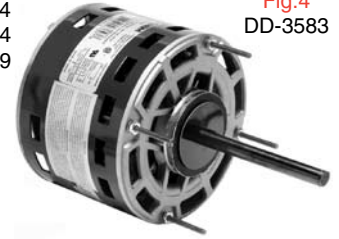

Fig.4
DD-3583

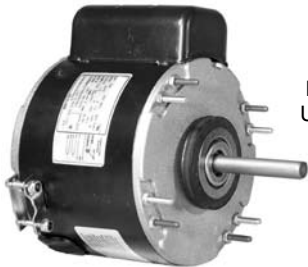

Fig.5
R12686
UH-9035

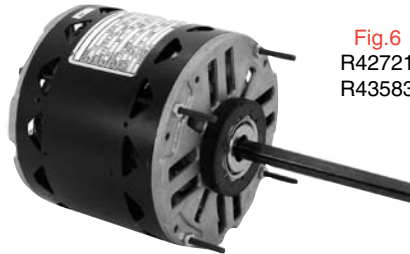

Fig.6
R42721
R43583



Fig.7
R42411
R42413

Motors continued from previous

Part #	HP	Amps	Spd/RPM	Rot.	Body	Shaft	Type	Encl.	Bearing	Comment	Fig.
DD-034	1/4	3.60	4/1075	REV.	3.40	6.0"x1/2"	5/370	OPEN	SLEEVE	FML1026, D1730, 3783, X034, 752, R42034, R42419	3
DD-3583	1/4	4.40	3/1075	REV.	4.04	4.5"x1/2"	5/370	OPEN	SLEEVE	DL1026, WG840583, 1863, D721, E201 3583 X000, 533, R43583	4
UH-9035	1/4	4.10	1/1075	REV.	4.52	3.4"x1/2"	INC	T.E.	BALL	UH1026, US1026, NB, 9035, D734, X303, X307. 566, 734, 750	5
R42034	1/4	3.30	4/1075	REV.PLUG	4.00	4.0"x1/2"	INC.	OPEN	SLEEVE	95H57,95H5701 ,67F14, 67F1401503667, 21742-C005, 23206-C001	3
R42413	1/4	3.60	3/1050	C.C.W.	4.30	4.8"x1/2"	INC.	OPEN	SLEEVE	FASCO D924, CARRIER P257-3983	7
R42419	1/4	3.60	3/1075	REV.PLUG	4.10	6.0"x1/2"	7.5/370	OPEN	SLEEVE	GE 3783, 3922, 5KCP39HGD444	3
R42721	1/4	4.10	3/1075	REV.PLUG	4.30	6.5"x1/2"	7.5/370	OPEN	SLEEVE	U.E. 139, 533,FASCO D721	6
R12486	1/4	4.10	1/1075	REV.PLUG	4.80	2.8"x1/2"	INC.	T.E.	SLEEVE	GE 3J344GX5, U.E. 486,566, 586, MARATHON X303	2
R42411	1/4	4.20	1/1050	C.C.W.	4.30	4.8"x1/2"	INC.	OPEN	SLEEVE	BLANCHARD 79001, ADDISON 8101-417	7
R43583	1/4	4.60	3/1075	REV.	4.06	4.5"x1/2"	5/370	OPEN	SLEEVE	GE 3583	6
R12686	1/4	4.90	1/1075	REV.	4.25	3.0"x1/2"	5/370	T.E.	SLEEVE	UNIT HEATER	5
R12586	1/4	4.90	1/1075	REV.PLUG	4.36	2.5"x1/2"	INC.	T.E.	BALL	MARATHON X307	2
R42416	1/4	5.00	3/1625	REV.PLUG	4.50	6.5"x1/2"	10/370	OPEN	SLEEVE	FASCO D782, G.E. 3471, 3992, 3996	1

Continued Next Page

5.5" Motors



Single Shaft - 115 Volts

Motors continued from previous

Sleeve & Ball Bearing - PSC - Open & Totally Enclosed

Motors



Fig.1
R42310
R42780



Fig.2
R12682
UH-9036



Fig.3
R42035
R42319
DD-035

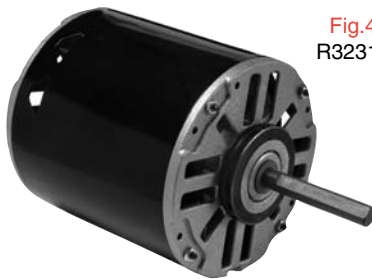

Fig.4
R32317

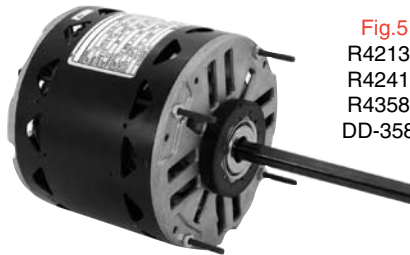

Fig.5
R42134
R42415
R43585
DD-3585

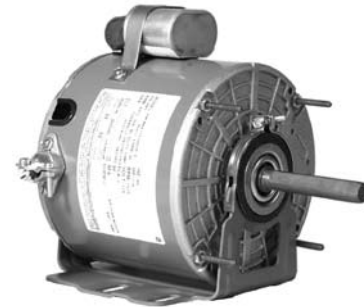

Fig.6
R183
R182

Part #	HP	Amps	Spd/RPM	Rot.	Body	Shaft	Type	Encl.	Bearing	Comment	Fig.
R42780	1/3	4.10	3/1625	REV.PLUG	4.60	6.5"x1/2"	7.5/370	OPEN	SLEEVE	FASCO D780, G.E. 3481, 3994	1
R12682	1/3	4.30	2/1100	REV.PLUG	5.00	5.0"x1/2"	INC.	T.E.	SLEEVE	70202, 588-269	2
R42035	1/3	4.80	4/1075	REV.PLUG	4.30	4.0"x1/2"	10/370 INC.	OPEN	SLEEVE	45H31,79A52,79A5201,45H69, 45H6901,57C2501,86G45,503881	3
R32317	1/3	4.80	1/825	C.C.W.	5.60	2.5"x1/2"	5/370	OPEN	SLEEVE	ARKLA B14506393, B14506363	4
R42310	1/3	6.00	4/1075	C.C.W.	4.00	5.2"x1/2"	5/370	OPEN	SLEEVE	24-18238-000, 41A4201, P-8-7505, P-8-9450	1
R42415	1/3	6.00	4/1050	C.C.W.	4.40	4.6"x1/2"	INC.	OPEN	SLEEVE	WESTINGHOUSE 321P677, BDP, CARRIER, AO SMITH 321P591	5
R42134	1/3	6.00	3/1075	REV.PLUG	4.60	6.5"x1/2"	7.5/370	OPEN	SLEEVE	U.E. 134, 140, 148, 532, FASCO D727, D926	5
R42319	1/3	6.00	3/1075	REV.PLUG	4.60	6.0"x1/2"	10/370	OPEN	SLEEVE	FRANKLIN 80827, G.E. 3785	3
R43585	1/3	6.40	3/1075	REV.	4.31	4.5"x1/2"	7.5/370	OPEN	SLEEVE	GE 3585	5
R183	1/3	6.50	1/1075	REV.PLUG	6.00	2.8"x1/2"	INC.	T.E.	BALL	FRANKLIN 73183, U.E. 183 FASCO D732	6
R182	1/3	6.50	1/1075	REV.PLUG	6.00	2.8"x1/2"	INC.	T.E.	SLEEVE	MARATHON X304,	6
DD-035	1/3	4.80	4/1075	REV	4.30	6.0"x1/2"	10/370	OPEN	SLEEVE	FML1036, D1731, 3785, X035, 753, 947,R42035, R42319	3
DD-3585	1/3	6.00	3/1075	REV	4.28	4.5"x1/2"	5/370	OPEN	SLEEVE	DL1036, WG480585, 1864, D727, E203, 3585, X0023, 532, R43585	5
UH-9036	1/3	5.00	1/1075	REV	4.52	3.5"x1/2"	INC	T.E.	BALL	UH1036, US1036, NB, 9036, D732, 3212, X304, X308, 183, 751	2

Continued Next Page

Single Shaft - 115 Volts

Sleeve & Ball Bearing - PSC - Open & Totally Enclosed



Fig.1
R43600
R43602

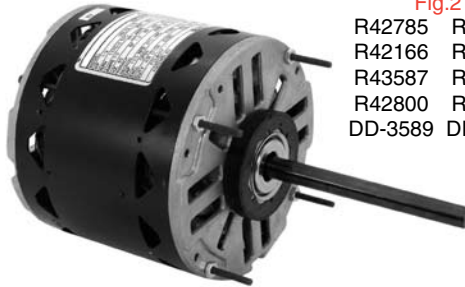

Fig.2
R42785 R43589
R42166 R42016
R43587 R42728
R42800 R42812
DD-3589 DD-3587



Fig.3
R42036
R42219
R42013
DD-036



Fig.4
R42241



Fig.5
R44587
R44589

Motors continued from previous

Part #	HP	Amps	Spd/RPM	Rot.	Body	Shaft	Type	Encl.	Bearing	Comment	Fig.
DD-036	1/2	8.20	4/1075	REV.	4.85	6.0"x1/2"	10/370	OPEN	SLEEVE	FML1056, D1732, 3787, X036, 754, R42036, R42219	3
DD-3587	1/2	7.80	3/1075	REV.	5.31	4.5"x1/2"	10/370	OPEN	SLEEVE	DL1056, WG840587, 1865, D701, E205, 3587, X004, 531, R43587	2
R44587	1/2	5.70	4/1075	C.C.W.	5.25	3.4"x1/2"	10/370	OPEN	SLEEVE	OLSEN 27836, 26088	5
R43600	1/2	7.00	4/1075	REV.PLUG	5.00	5.0"x1/2"	10/370	OPEN	SLEEVE	EMERSON K55HXMDA-4122, RHEED RUDD 51-23012-41	1
R42785	1/2	7.40	3/1625	REV.PLUG	5.20	6.5"x1/2"	15/370	OPEN	SLEEVE	FASCO D785, G.E. 3491	2
R42166	1/2	7.40	3/1075	REV.PLUG	5.20	6.5"x1/2"	10/370	OPEN	SLEEVE	FASCO D701,D902, U.E.103,166,531, MARATHON X004	2
R42219	1/2	7.40	3/1075	REV.PLUG	5.20	6.0"x1/2"	10/370	OPEN	SLEEVE	FRANKLIN 80142, G.E. 3787	3
R42036	1/2	8.00	4/1075	REV.PLUG	4.80	4.0"x1/2"	INC	OPEN	SLEEVE	9" OR 10" BOLT CIRCLE C/W 30" LEADS	3
R43587	1/2	9.00	3/1075	REV.	5.06	4.5"x1/2"	10/370	OPEN	SLEEVE	GE 3587	2
R42800	1/2	11.00	4/1050	REV.PLUG	5.80	5.5"x5/8"	15/370	OPEN	BALL	HEIL-QUAKER, KA55FYEPZZ998	2
DD-3589	3/4	10.50	3/1075	REV.	5.61	4.5"x1/2"	15/370	OPEN	SLEEVE	DL1076, WG840589, 8904, D728, E207, 3589, X009, 678, R43589	2
R43602	3/4	9.10	4/1075	REV.	5.00	4.0"x1/2"	10/370	OPEN	BALL	MULTI HP 3/4 - 1/5	1
R42013	3/4	9.80	3/1075	REV.PLUG	5.30	6.0"x1/2"	15/370	OPEN	SLEEVE	G.E.3789	3
R43589	3/4	10.30	3/1075	REV.	5.63	4.5"x1/2"	15/370	OPEN	SLEEVE	GE 3589	2
R44589	3/4	11.00	4/1050	C.C.W.	5.80	3.4"x1/2"	20/370	OPEN	SLEEVE	OLSEN 27161	5
R42016	3/4	11.50	3/1625	REV.PLUG	5.80	6.5"x1/2"	15/370	OPEN	SLEEVE	G.E.3974, 3998, 5KCP39PGE415	2
R42241	3/4	11.50	4/1075	REV.PLUG	7.00	2.9"x1/2"	15/370	OPEN	BALL	HC45SA114, BDP P251-2702, EMERSON K7023, GE S3157	4
R42728	3/4	11.80	3/1075	REV.PLUG	5.30	6.5"x1/2"	15/370	OPEN	SLEEVE	U.E.465, FASCO D728	2
R42812	1	14.00	3/1075	REV.PLUG	5.90	6.5"x1/2"	20/370	OPEN	SLEEVE	GENERAL REPLACEMENT	2

Rotation determined opposite shaft end
Double shaft determined at lead end

Shaft length measured from hub
face to shaft end

5.5" Motors



Double Shaft - 115 Volts

Sleeve Bearing - PSC - Open & Totally Enclosed

Motors

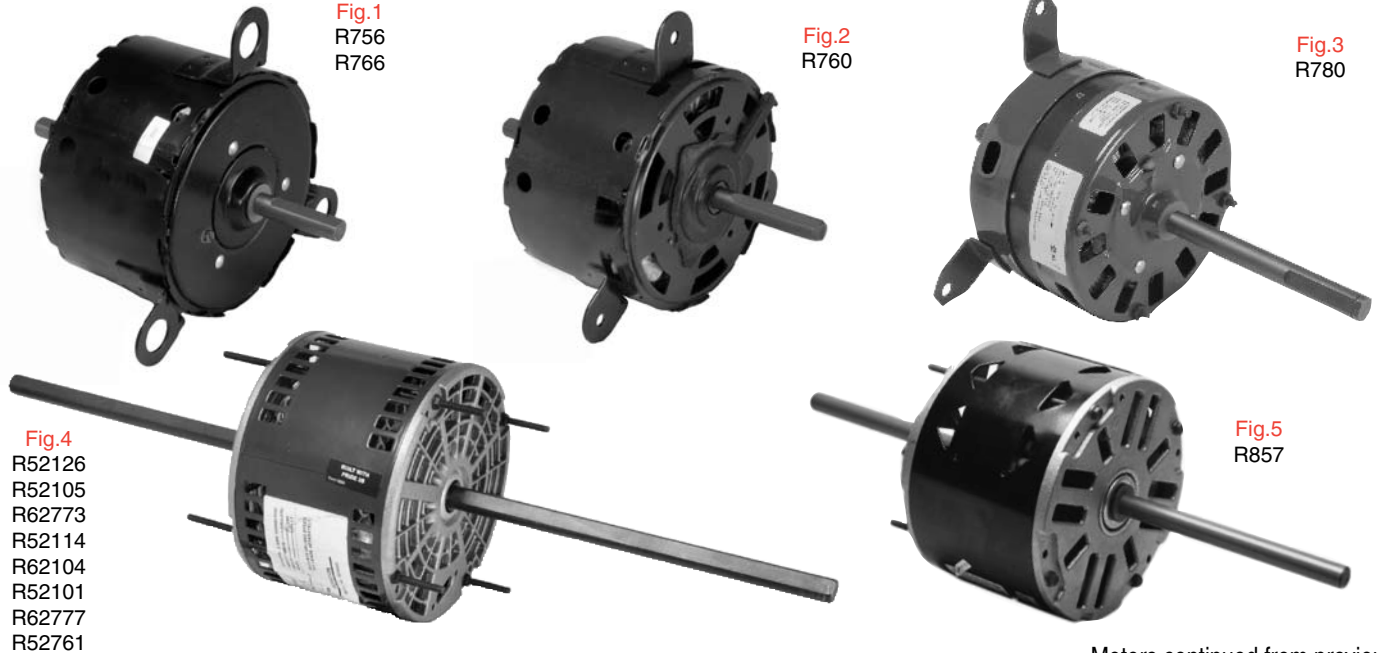

Motors continued from previous

Part #	HP	Amps	Spd/RPM	Rot	Body	Shaft	Cap	Encl.	Bearing	Comment	Fig.
R756	1/12	1.30	3/1080	C.C.W.	3.50	2.0"x1/2"x2.2"	5/370	T.E.	SLEEVE	KEEPRITE 122960, 126063,126212, 90527-1	1
R760	1/8	1.30	3/1100	C.W.	3.60	2.0"x1/2"x2.8"	12.5/370	OPEN	SLEEVE	AIRTEMP 3525153, YORK 24-14098-000	2
R780	1/8	1.70	3/1330	C.W.	3.50	2.4"x1/2"x5.1"	10/370	OPEN	SLEEVE	200423, 71213, 71924, 71925,88452, 88898, 89395, SM711	3
R857	1/8	2.00	3/1100	C.C.W.	3.75	3.0"x1/2"x4.5"	5/370	OPEN	SLEEVE	FASCO D857	5
R52105	1/8	2.40	3/1075	C.C.W.	4.00	7.8"x1/2"x8.5"	5/370	OPEN	SLEEVE	U.E.105, FASCO D751, D765	4
R766	1/6	1.70	3/1225	C.C.W.	4.00	1.9"x1/2"x2.4"	15/370	T.E.	SLEEVE	KEEPRITE 127883, 127965,130142, 130293, 130392,SM718	1
R52126	1/6	3.00	3/1075	C.C.W.	4.00	7.8"x1/2"x8.2"	5/370	OPEN	SLEEVE	U.E.122, 126, 478, WJ94X511	4
R62773	1/4	3.40	3/1625	C.C.W.	4.36	7.9"x1/2"x7.6"	5/370	OPEN	SLEEVE	FASCO D773, D776,CAMCO WJ94X95	4
R52114	1/4	4.80	3/1075	C.C.W.	4.25	7.8"x1/2"x8"	5/370	OPEN	SLEEVE	U.E. 114, 479, FASCO D850,D852	4
R62104	1/3	4.00	3/1625	C.C.W.	4.61	7.3"x1/2"x8.0"	5/370	OPEN	SLEEVE	FRANKLIN 80980, U.E. 104,FASCO D770	4
R52101	1/3	5.00	3/1075	C.C.W.	4.80	7.2"x1/2"x7.9"	5/370	OPEN	SLEEVE	U.E.101, G.E.3681, 3685	4
R62777	1/2	6.00	3/1625	C.C.W.	5.11	7.2"x1/2"x7.6"	5/370	OPEN	SLEEVE	FASCO D777	4
R52761	1/2	9.40	3/1075	C.C.W.	5.50	6.8"x1/2"x7.4"	7.5/370	OPEN	SLEEVE	FRANKLIN 80562, FASCO D761,D883	4

Single Shaft - 208/230 Volts - Open

Sleeve & Ball Bearing - PSC

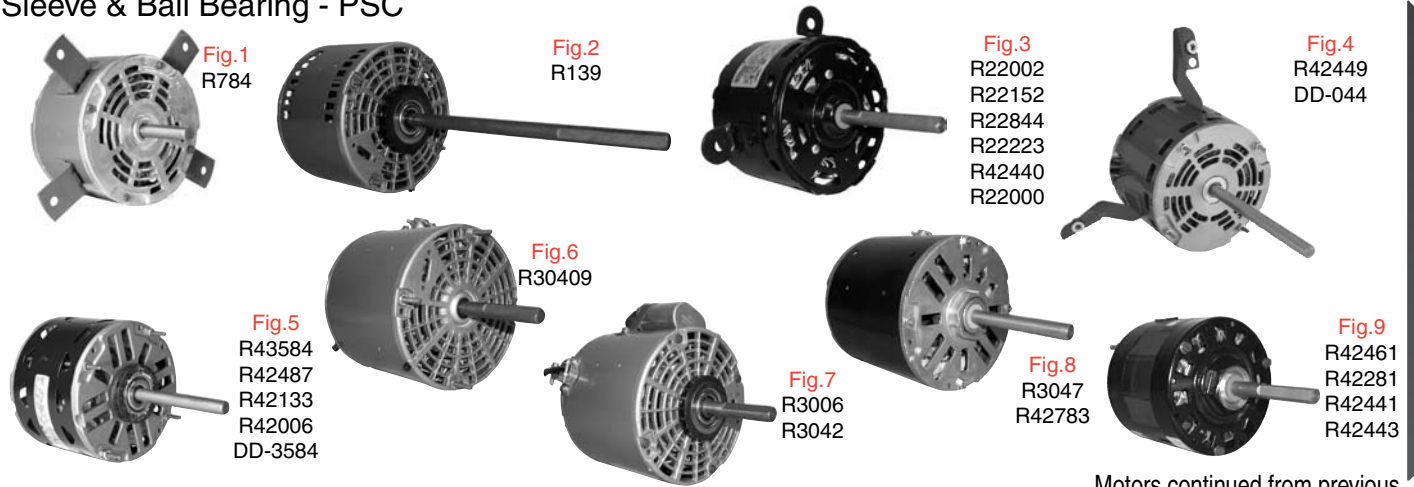

Motors continued from previous

Part #	HP	Amps	Spd/RPM	Rot.	Body	Shaft	Cap.	Bearing	Comment	Fig.
R784	1/20	0.40	3/1060		3.50	2.3"x1/2"	4/370	SLEEVE	KEEPRITE 130784	1
R139	1/8	1.00	1/1075	C.W.	4.00	9.0"x1/2"	4/5/370	SLEEVE	FRANKLIN 74007	2
R3006	1/6	1.20	1/1625	C.W.	4.20	1.5"x1/2"	INC.	BALL	GE3006	7
R22002	1/6	1.30	1/1065	C.W.	3.50	3.0"x1/2"	4/370	SLEEVE	AIRTEMP 3775858,CARRIER HC38VE230	3
R22223	1/5	1.30	1/1075	C.C.W.	3.80	2.8"x1/2"	4/370	SLEEVE	CARRIER HC37VE230, FASCO D842, UE 152, 230 volt only	3
R22152	1/5	1.30	2/1050	REV.	3.40	4.0"x1/2"	5/440	SLEEVE	CARRIER HC37ML702, U.E. 152,178, 537, FASCO D842	3
R30409	1/5	1.80	1/1550	C.C.W.	4.60	3.0"x1/2"	4/370	SLEEVE	KEEPRITE 120409	6
DD-044	1/4	1.70	4/1075	REV.	3.40	6.0"x1/2"	4/370	SLEEVE	D1733, 3784, M R42449	4
DD-3584	1/4	1.70	3/1075	REV.	4.04	4.5"x1/2"	5/370	SLEEVE	D1026, WG840584, 1971, D725, E202, 3584, X001, 530, R43584	5
R22844	1/4	1.40	1/1625	C.C.W.	3.80	4.0"x1/2"	4/370	SLEEVE	FASCO D844	3
R42449	1/4	1.50	3/1075	REV.PLUG	4.10	6.0"x1/2"	5/370	SLEEVE	INTERTHERM 6207000, 6207010,6207020	4
R3047	1/4	1.50	1/1625	C.W.	4.30	2.5"x1/2"	5/370	SLEEVE	COPELAND 050-0107-01, 0238-00 G.E. 3047, 5KCP39GG3537S	8
R43584	1/4	1.80	3/1075	REV.	4.06	4.5"x1/2"	5/370	SLEEVE	GE 3584	5
R42461	1/4	1.80	3/1625	REV.PLUG	4.50	6.5"x1/2"	5/370	SLEEVE	TRANE WW94X264,265,284,417,U.E. 456	9
R42783	1/4	1.80	1/1625	REV.PLUG	4.50	6.0"x1/2"	5/370	SLEEVE	FASCO D783, S3472, GE 5KCP39DG3334T	8
R3042	1/4	1.90	1/1625	C.C.W.	4.80	2.5"x1/2"	INC.	BALL	S3042, FASCO D870	7
R42133	1/4	1.90	3/1075	REV.PLUG	4.30	6.5"x1/2"	5/370	SLEEVE	U.E. 133, 530, FASCO D725	5
R42006	1/4	2.00	1/1075	REV.PLUG	4.30	4.0"x1/2"	5/370	SLEEVE	FASCO D1749, EMERSON D935,HC39MZ228, UE443,5KCP39EG3314	5
R22000	1/4	2.10	1/1075	C.C.W.	3.80	3.2"x1/2"	5/370	SLEEVE	HC39ME701, SL710, VB230,HC39VE233, VE230,VL208,VL701	3
R42440	1/4	2.20	2/1075	REV.	4.00	4.0"x1/2"	5/440	SLEEVE	U.E. 514, FASCO D843, CARRIER HC39ML702	3
R42281	1/4	2.20	1/1075	C.C.W.	4.30	2.5"x1/2"	4/370	SLEEVE	LENNOX P-8-2702, S3004 FASCO D814, GE 5KCP39GGA124S, 230 Volt only	9
R42441	1/4	2.50	1/1050	C.C.W.	4.30	3.9"x1/2"	INC.	SLEEVE	U.E.443, ADDISON 8101-191, BLANCHARD 79002, 79003	9
R42443	1/4	2.70	3/1050	C.C.W.	4.30	3.9"x1/2"	INC.	SLEEVE	CARRIER P251-6407, P257-3984	9

Motors continued next page

Rotation determined opposite shaft end
Double shaft determined at lead end

Shaft length measured from hub
face to shaft end

5.5" Motors



Single Shaft - 208/230 Volts - Open

Sleeve & Ball Bearing - PSC

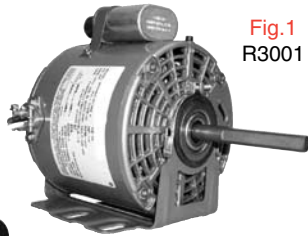

Fig.1
R3001

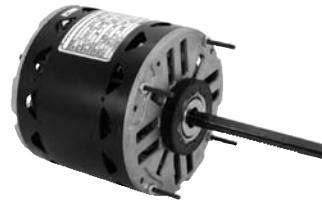

Fig.2
R42781
R42132
R43586
R32117
DD-3586



Fig.3
R22011
R22012

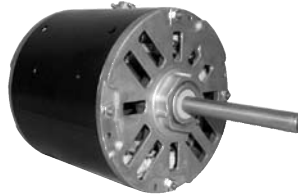

Fig.4
R3005
R32011



Fig.5
R10810

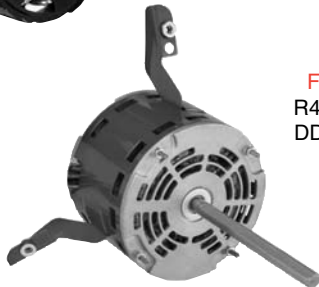

Fig.6
R42349
DD-045



Fig.7
R42237

Motors continued from previous

Part #	HP	Amps	Spd/RPM	Rot.	Body	Shaft	Cap.	Bearing	Comment	Fig.
DD-045	1/3	2.30	4/1075	REV.	4.30	6.0"x1/2"	10/370	SLEEVE	FM1036, D1734, 3786, R42349	6
DD-3586	1/3	2.60	3/1075	REV.	4.28	4.5"x1/2"	5/370	SLEEVE	D1036, WG840586, 1972, D923, E204, 3586,X003, 529, R43586	2
R3001	1/3	1.80	1/1625	C.W.	4.50	3.5"x1/2"	INC.	SLEEVE	HILL PP3955B, G E 3001, 5KCP39KG1369	1
R42781	1/3	2.30	3/1625	REV.PLUG	4.60	6.5"x1/2"	5/370	SLEEVE	U.E.454, FASCO D781, D787	2
R32011	1/3	2.30	3/1625	REV.PLUG	5.30	6.0"x1/2"	5/370	SLEEVE	FASCO D781, 5KCP39HGE214T	4
R3005	1/3	2.40	1/825	C.W.	5.00	3.5"x1/2"	12.5/370	SLEEVE	COPELAND 050-0107-00, 0234-00G.E.3005, 5KCP39PG3224, 915S	4
R22011	1/3	2.50	2/1075	REV.	4.80	4.0"x1/2"	5/370	SLEEVE	YORK 24-12737-000	3
R22012	1/3	2.50	2/1075	REV.	4.00	4.0"x1/2"	5/370	SLEEVE	U.E.536, FASCO D803	3
R10810	1/3	2.70	1/1625	C.W.	4.50	7.5"x1/2"	3/370	SLEEVE	208 Volt only	5
R42132	1/3	3.00	3/1075	REV.PLUG	5.00	6.0"x1/2"	5/370	SLEEVE	FASCO D723,D923, U.E.132, 529, MARATHON X003	2
R43586	1/3	3.10	3/1075	REV.	4.31	4.5"x1/2"	5/370	SLEEVE	GE 3586	2
R42349	1/3	3.70	3/1075	REV.PLUG	4.60	6.0"x1/2"	7.5/370	SLEEVE	GE 3786, CARRIER HC39XE224HC41ME244, HC43ME244	6
R32117	1/3	3.80	1/825	REV.PLUG	5.90	5.3"x1/2"	4/370	SLEEVE	U.E.117, FASCO D2017, D2817, LENNOX P-8-2948, P-8-9080	2
R42237	1/3	4.80	4/1075	REV.PLUG	5.30	6.0"x1/2"	10/440	SLEEVE	CARRIER HC41SE651, HC39SE651BDP P251-5306, P251-5408	7

Motors continued next page

Motors

Single Shaft - 208/230 Volts - Open

Sleeve & Ball Bearing - PSC



Fig.1
R43601
R42784



Fig.2
R22017
R32237
R32184

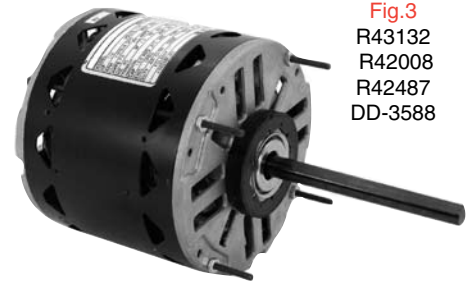

Fig.3
R43132
R42008
R42487
DD-3588

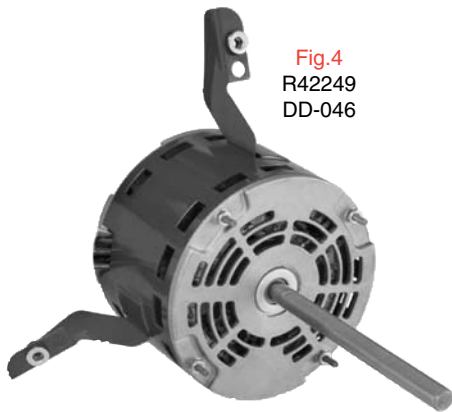

Fig.4
R42249
DD-046



Fig.5
R32241

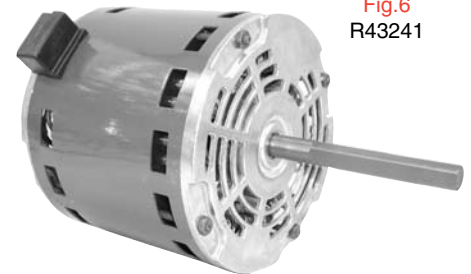

Fig.6
R43241

Motors continued from previous

Part #	HP	Amps	Spd/RPM	Rot.	Body	Shaft	Cap.	Bearing	Comment	Fig.
DD-046	1/2	3.80	4/1075	REV.	4.85	6.0"x1/2"	10/370	SLEEVE	FM1056, D1735, 3788, R42449	1
DD-3588	1/2	3.60	3/1075	REV.	5.31	4.5"x1/2"	7.5/370	SLEEVE	D1056, WG840588, 1973, D703, E206, 3588, X005, 528, R43588	3
R42487	1/2	3.40	3/1075	REV.PLUG	5.10	6.5"x1/2"	7.5/370	SLEEVE	FASCO D703, D841, U.E.149, 487, 528, MARATHON X005	3
R42784	1/2	2.80	3/1625	REV.PLUG	5.20	6.5"x1/2"	7.5/370	SLEEVE	U.E.461, FASCO D784	1
R43601	1/2	2.80	4/1075	REV.PLUG	4.60	4.9"x1/2"	5/7.5/ 10/370	SLEEVE	LENNOX 76N18, GE MARS 03464R-R 51-23022-41, EMERSON 5461	1
R32241	1/2	4.00	1/1075	REV.	7.70	4.5"x1/2"	INC.	BALL	DUNHAM BUSH MTR-226, 208/230/460 volts	5
R22017	1/2	4.00	1/1075	C.C.W.	7.40	4.5"x1/2"	7.5/370	SLEEVE	FASCO D804, CARRIER HC44SL230	2
R32237	1/2	4.10	1/825	C.C.W.	5.80	2.7"x1/2"	12.5/370	BALL	ARKLA B14506354, B14506396	2
R43588	1/2	4.30	3/1075	REV.	4.81	4.5"x1/2"	7.5/370	SLEEVE	GE 3588	3
R42008	1/2	4.50	1/1075	REV.PLUG	5.50	4.0"x1/2"	7.5/370	SLEEVE	HC43MZ228, EMERSON K940, U.E. 445, G.E. KCP39NGD123T	3
R42249	1/2	4.90	3/1075	REV.PLUG	5.10	6.0"x1/2"	10/370	SLEEVE	GE 3788	1
R32184	1/2	5.10	3/1075	C.C.W.	5.30	3.5"x1/2"	10/370	SLEEVE	YORK 024-21671-000	3
R43241	1/2	4.40	3/1000	C.C.W.	5.10	3.9"x1/2"	7.5/370	SLEEVE	YORK 024-24106-000	6

Motors continued next page

5.5" Motors



Single Shaft - 208/230 Volts - Open

Sleeve & Ball Bearing - PSC

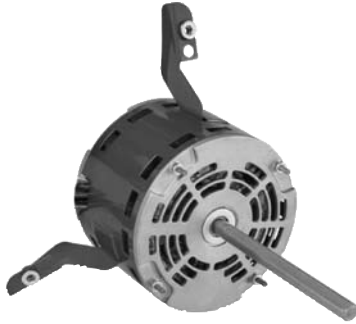

Fig.1
R42043

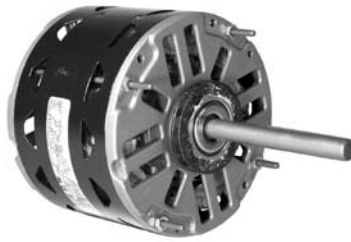

Fig.2
DD-3590
R42023
R42049
R42211
R42242
R42257
R42786
R42842
R43590
R43603



Fig.3
R42404
R42464



Fig.4
R32058

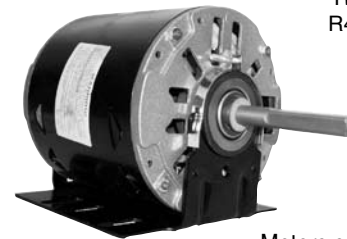

Fig.5
R3067
R42141

Motors continued from previous

Part #	HP	Amps	Spd/RPM	Rot.	Body	Shaft	Cap.	Bearing	Comment	Fig.
R43603	3/4	3.90	4/1075	REV.	5.00	4.0"x1/2"	10/370	BALL	MULTI HP 3/4 - 1/5	2
DD-3590	3/4	4.60	3/1075	REV.	5.61	4.5"x1/2"	10/370	SLEEVE	D1076, WG840590, 8905, D729, E208, 3590, Z010, 679, R43590	2
R43590	3/4	5.00	3/1075	REV.	5.50	4.5"x1/2"	10/370	SLEEVE	GE 3590	2
R42043	3/4	5.00	3/1075	REV.PLUG	5.30	6.0"x1/2"	10/370	SLEEVE	CARRIER HC43ME241, 242, 243, GE 3790	1
R42404	3/4	5.20	3/1075	C.C.W.	6.00	3.0"x1/2"	7.5/370	BALL	YORK 024-18404	3
R42257	3/4	5.40	4/1075	REV.	5.50	6.0"x1/2"	10/440	SLEEVE	CARRIER HC45SE651, BDP P251-5701, EMERSON K3845	2
R42786	3/4	5.50	3/1625	REV.PLUG	5.60	6.5"x1/2"	7.5/370	SLEEVE	U.E.483, FASCO D786, D789	2
R42049	3/4	5.90	3/1075	REV.PLUG	5.30	6.5"x1/2"	10/370	SLEEVE	U.E.150, 488, FASCO D729, D730 GE 3296, 3990	2
R42842	1	6.50	3/1075	REV.PLUG	5.50	6.5"x1/2"	20/370	SLEEVE	TRANE WW94X249, FASCO D711, ADDISON 8101-439	2
R42023	1	5.30	3/1075	REV.PLUG	7.00	5.0"x1/2"	15/370	BALL	U.E. 586, YORK 024-21672C	2
R42464	1	5.40	3/1075	REV.PLUG	6.50	3.5"x5/8"	12.5/370	BALL	KEEPRITE 504464, MARATHON 48A119746	3
R42242	1	6.20	3/1000	REV.PLUG	7.30	4.0"x5/8"	25/370	BALL	CARRIER HC52AL230, 231, 232, HC52SE208, BDP P251-5101, 5102	2
R42211	1	6.20	2/1625	REV.	6.30	2.5"x1/2"	10/370	BALL	ARMSTRONG, FASCO D825, UE422GE 5KCP35SG644S	2
R32058	1	7.00	3/1100	C.C.W.	7.00	4.0"x1/2"	15/370	BALL	YORK 024-21672C	4
R3067	1	7.10	1/1075	REV.	9.20	3.8"x1/2"	15/370	BALL	HILL PP19162G, GE 3067, 5KCP39PGC910S, 5KCP39PGC030S	5
R42141	1	7.60	1/1075	REV.	8.50	4.0"x1/2"	INC.	BALL	KRAMER DD661, DD791	5

Single Shaft - 208/230 Volts - Semi-Enclosed

Sleeve & Ball Bearing - PSC

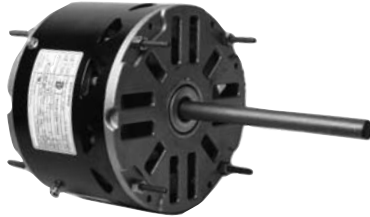

Fig.1
R22719
R22444

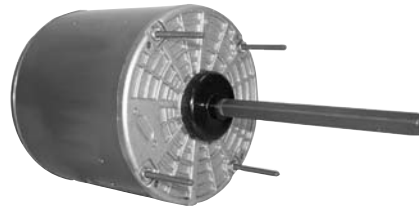

Fig.2
R22242 R32477
R31672 R32703
R32097 R32735
R32739 R32730
R32475
R32476

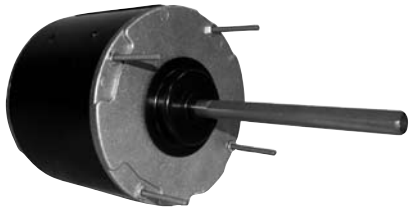

Fig.3 R22746
R22474 R22748
R22475 R32702
R22532 R32705
R22745 R32706
R22648 R22755



Fig.4
R32160

Part #	HP	Amps	RPM	Rot.	Body	Shaft	Cap	Bearing	Comment	Fig.
R22532	1/6	1.10	2/1075	REV.PLUG	3.70	6.5"x1/2"	5/370	SLEEVE	GENERAL REPLACEMENT	3
R22648	1/6	1.30	2/825	REV.PLUG	4.50	6.5"x1/2"	5/370	SLEEVE	KEEPRITE 171318, TRANE WW94X296, YORK 24-21720-000	3
R31672	1/6	1.50	2/1050	C.W.	4.00	3.5"x1/2"	7.5/370	BALL	KEEPRITE 171672, 120240 <i>230 volts only</i>	2
R22719	1/5	1.40	2/1075	REV.PLUG	3.70	5.5"x1/2"	5/370	SLEEVE	U.E.442, FASCO D719	1
R32097	1/4	1.67	2/825	REV.	4.00	6.0"x1/2"	5/370	BALL	GENERAL REPLACEMENT	2
R32702	1/4	1.80	2/1075	REV.	4.60	6.5"x1/2"	5/370	BALL	GENERAL REPLACEMENT	3
R32739	1/4	1.98	2/1075	REV.	4.30	6.5"x1/2"	5/370	BALL	FASCO D739	2
R22474	1/4	1.90	2/825	REV.PLUG	5.10	6.5"x1/2"	7.5/370	SLEEVE	U.E.474	3
R32160	1/4	2.00	2/1075	C.W.	4.30	3.7"x1/2"	5/370	SLEEVE	YORK 024-16076-700	4
R22475	1/3	2.50	2/825	REV.PLUG	5.60	6.5"x1/2"	12.5/370	SLEEVE	U.E.475, FASCO D898	3
R32475	1/3	2.60	2/1075	REV.	4.80	6.5"x1/2"	7.5/370	BALL	F1036, F45SN6V26, 323P199,323P946	2
R32476	1/3	2.60	2/825	REV.	5.30	6.5"x1/2"	7.5/370	BALL	U.E. 476, FASCO D791, MARATHON X086	2
R32703	1/3	2.60	2/1075	REV.	5.10	6.5"x1/2"	7.5/370	BALL	GENERAL REPLACEMENT	2
R22746	1/3	2.60	2/1075	REV.PLUG	4.80	6.5"x1/2"	7.5/370	SLEEVE	U.E.156, FASCO D746	3
R22748	1/3	2.60	2/1075	REV.PLUG	4.30	6.5"x1/2"	5/370	SLEEVE	U.E.397, 501, FASCO D747,D748	3
R22444	1/3	2.80	2/1075	REV.PLUG	4.40	5.5"x1/2"	7.5/370	SLEEVE	RHEEM-RUUD 512068801, 901, 512069001, U.E.444	1
R32477	1/2	3.40	2/825	REV.	5.50	6.5"x1/2"	10/370	BALL	U.E. 477, FASCO D790	2
R32705	1/2	3.60	2/1075	REV.	1.00	6.5"x1/2"	10/370	BALL	GENERAL REPLACEMENT	3
R32735	1/2	4.20	2/1075	REV.	5.10	6.5"x1/2"	10/370	BALL	U.E. 157, FASCO D735	2
R22242	1/2	4.20	2/1075	REV.PLUG	5.10	6.5"x1/2"	10/370	SLEEVE	U.E.499, CARRIER HC43ME230HC43SZ230	2
R22745	1/2	4.40	2/1075	REV.PLUG	4.80	6.5"x1/2"	5/370	SLEEVE	U.E. 445, 502, FASCO D745	3
R32706	3/4	4.20	2/1075	REV.	1.00	6.0"x1/2"	15/370	BALL	GENERAL REPLACEMENT	3
R22755	3/4	5.00	2/1075	REV.PLUG	5.60	6.5"x1/2"	10/370	SLEEVE	F48SQ6L66	3
R32730	3/4	5.10	2/1075	REV.	5.50	6.5"x1/2"	15/370	BALL	MARATHON X085, X090, X095, FASCO D930, U.E. 527	2

5.5" Motors



Single Shaft - 208/230 Volts - Totally Enclosed

Sleeve & Ball Bearing - PSC

Fig.1

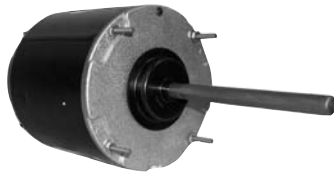

CF-814 R22465
 CF-3726 R22470
 CF-3732 R22472
 R22019 R22645
 R22170 R22847
 R22184 R31700
 R22401 R31702
 R22402 R32442
 R22450 R32445
 R22455 R32642

Fig.2
 R22576
 R785



Fig.3
 R22180

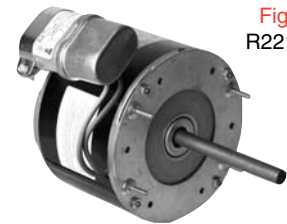

Part #	HP	Amps	Spd/RPM	Rot.	Body	Shaft	Cap	Bearing	Comment	Fig.
R22465	1/10	0.63	2/825	REV.PLUG	4.10	6.0"x1/2"	5/370	BALL	0321	1
R22576	1/9	1.30	2/1060	C.W.	3.80	1.5"x1/2"	3/370	SLEEVE	KEEPRITE HOTEL ALL SEASON INCREMENTALS 128576	2
R22470	1/8	0.90	2/825	REV.PLUG	4.20	6.0"x1/2"	5/370	BALL	D799-3202	1
R22847	1/8	0.90	2/825	REV.PLUG	4.20	4.8"x1/2"	5/370	SLEEVE	RHEEM RUUD 2076301, 2127601,2127602	1
CF-3726	1/6	1.30	1/1075	REV.	3.94	6.0"x1/2"	5/370	BALL	FSE1016S,SV1, FE1016S, WG840728, 1859, D917, 3727, X411, X427, 184, R31700	1
R785	1/6	0.90	2/1060	C.W.	3.30	2.3"x1/2"	3/370	SLEEVE	KEEPRITE 128577	2
R32642	1/6	1.30	2/1075	REV.PLUG	4.80	6.0"x1/2"	3/370	BALL	U.E.554, FASCO D773, D905, KEEPRITE 120240, 128577	1
R22019	1/6	1.30	2/1075	REV.PLUG	3.80	6.0"x1/2"	5/370	SLEEVE	GENERAL REPLACEMENT	1
R22184	1/6	1.30	2/1075	REV.PLUG	3.80	6.0"x1/2"	5/370	SLEEVE	U.E.136, 184	1
R31700	1/6	1.30	2/1075	REV.PLUG	1.00	6.0"x1/2"	3/370	BALL	GENERAL REPLACEMENT	1
R22472	1/6	1.60	2/825	REV.PLUG	4.10	5.6"x1/2"	5/370	BALL	3203 D793	1
R22645	1/6	1.60	2/825	REV.PLUG	4.40	6.0"x1/2"	5/370	SLEEVE	RHEEM RUUD	1
R22401	1/6	2.00	1/1075	REV.	4.10	6.7"x1/2"	7.5/370	SLEEVE	MULTI HP 1/3 - 1/6	1
R22402	1/6	2.00	1/1075	REV.	4.10	6.7"x1/2"	7.5/370	BALL	MULTI HP 1/3 - 1/6	1
R22170	1/5	1.30	2/1075	C.C.W.	3.70	3.7"x1/2"	3/370	SLEEVE	RHEEM RUUD 512068001,002, 101201,501,512182601,701,801	1
R22180	1/5	1.30	2/1080	C.W.	3.70	4.3"x1/2"	INC.	SLEEVE	FEDDERS S196-179-1, FASCO D882	3
CF-3732	1/4	1.80	1/1075	REV.	4.16	6.5"x1/2"	5/370	BALL	FSE1026S,SV1, FE1026S,SB, WG840728, 1860, 1876, D909, D7909,E221, 3728, 3732,X412, X428,176, R31702	1
CF-814	1/4	1.70	1/825	REV.	5.25	6.5"x1/2"	5/370	BALL	FSE1028S, FE1028S, F1028, 1874, D934, D797, D792, 3040, X450, X097, 175, R31703	1
R31702	1/4	1.80	2/1075	REV.PLUG	4.30	6.0"x1/2"	5/370	BALL	GENERAL REPLACEMENT	1
R32442	1/4	1.80	2/1075	REV.PLUG	4.60	6.0"x1/2"	5/370	BALL	KEEPRITE 121113, 155484, 179656, U.E. 555	1
R22455	1/4	1.80	2/1075	REV.PLUG	4.40	6.0"x1/2"	5/370	SLEEVE	U.E. 176, 188, 455, FASCO D742, D749	1
R32445	1/4	1.90	1/825	REV.PLUG	4.60	6.0"x1/2"	5/370	BALL	GENERAL REPLACEMENT	1
R22445	1/4	1.90	1/825	REV.PLUG	4.90	6.0"x1/2"	7.5/370	SLEEVE	EMERSON K1874, TRANE MOT6039, UE 739, FASCO D797	1
R22749	1/4	1.90	1/1075	REV.PLUG	4.00	6.5"x1/2"	5/370	SLEEVE	323P854, 323P965, F48SF615	1
R22450	1/4	2.50	2/1625	REV.PLUG	4.60	6.0"x1/2"	5/370	SLEEVE	GENERAL REPLACEMENT	1

Motors continued next page

Motors

Single Shaft - 208/230 Volts - Totally Enclosed

Motors continued from previous

Sleeve & Ball Bearing - PSC

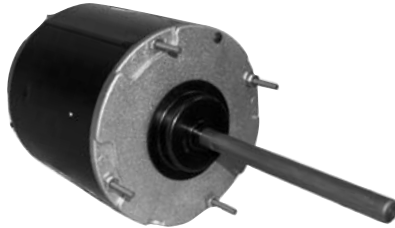

Fig.1

- R22175 R32556
- R22015 R32557
- R31703 R22168
- R31705 R22245
- R22345 CF-3733
- R22016 CF-813
- R22187 CF-3734
- R22460 CF-3735
- R31706

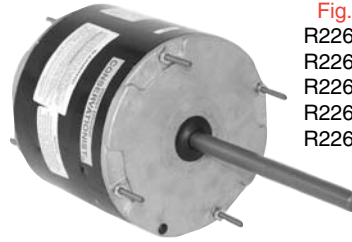

Fig.2

- R22601
- R22602
- R22603
- R22604
- R22605



Fig.3
R22140

Part #	HP	Amps	Spd/RPM	Rot.	Body	Shaft	Cap	Bearing	Comment	Fig.
R22601	1/3	1.90	2/825	REV.	4.80	5.0"x1/2"	10/370	BALL	MULTI HP 1/3 - 16	2
R22605	1/3	2.80	2/1075	REV.	4.80	6.0"x1/2"	7.5/370	BALL	MULTI HP 1/3 - 1/6	2
CF-3733	1/3	2.80	1/1075	REV.	5.15	6.5"x1/2"	7.5/370	BALL	FSE1036S, SV1, FE1036S, SB, WG840729, 1861, 1877, D908, D7908, 3733, 3729, E222, X413, 175, R31703	1
CF-813	1/3	1.90	1/825	REV.	5.00	6.5"x1/2"	7.5/370	BALL	FSE1038S, FE1038S, F1038, 1875, D936, D796, 791, D3026, X451, X086, 475,740, 467, R22345	1
R22345	1/3	2.40	1/825	REV.PLUG	5.50	6.0"x1/2"	7.5/370	SLEEVE	GENERAL REPLACEMENT	1
R32556	1/3	2.60	2/1075	REV.PLUG	5.10	6.0"x1/2"	7.5/370	BALL	U.E.556, FASCO D731, D737, KEEPRITE 121924, 161585	1
R22175	1/3	2.80	2/1075	REV.PLUG	5.00	6.0"x1/2"	7.5/370	SLEEVE	U.E. 175, 186	1
R22015	1/3	2.80	2/1075	REV.PLUG	4.80	6.0"x1/2"	7.5/370	SLEEVE	TRANE WW94X216, 256, 304, 305,325,WW94X335, 352, 354, 904	1
R31703	1/3	2.80	2/1075	REV.PLUG	5.10	6.0"x1/2"	7.5/370	BALL	GENERAL REPLACEMENT	1
R22603	1/2	2.40	2/825	REV.	4.80	6.0"x1/2"	12.5/370	BALL	MULTI HP 1/2 - 1/5	2
R22245	1/2	3.70	1/825	REV.PLUG	5.60	6.0"x1/2"	10/370	SLEEVE	FSE1058S, F48SR8L3	1
R22602	1/2	3.90	2/1075	REV.	4.80	5.0"x1/2"	12.5/370	BALL	GENERAL REPLACEMENT	2
CF-3734	1/2	3.50	1/1075	REV.	5.58	6.5"x1/2"	10/370	BALL	FSE1056S, SV1, FE1056S,SB, WG840730, 1862, 1878, D907, D7907, E223, 3730, 3734, X414, 187, 5578, R31705	1
R22140	1/2	2.70	2/1090	C.W.	5.00	3.4"x1/2"	7.5/370	SLEEVE	YORK 024-24110-701	3
R31705	1/2	3.50	2/1075	REV.PLUG	1.00	6.0"x1/2"	10/370	BALL	GENERAL REPLACEMENT	1
R22016	1/2	4.00	2/1075	REV.PLUG	5.20	6.0"x1/2"	10/370	SLEEVE	FASCO D717, YORK 24-17420-00024-70797-000, TRANE WW94X303,343	1
R22187	1/2	4.00	2/1075	REV.PLUG	5.20	6.0"x1/2"	10/370	SLEEVE	U.E. 187, FASCO D740	1
R32557	1/2	4.20	2/1075	REV.PLUG	5.50	6.0"x1/2"	10/370	BALL	KEEPRITE 155483, U.E. 557	1
R22460	1/2	4.20	2/1625	REV.PLUG	5.60	6.0"x1/2"	5/370	SLEEVE	GENERAL REPLACEMENT	1
R22604	3/4	5.30	2/1075	REV.	4.80	6.0"x1/2"	15/370	BALL	MULTI HP 3/4 - 1/4	2
CF-3735	3/4	5.10	1/1075	REV.	5.88	6.5"x1/2"	15/370	BALL	FSE1076S,SV1, FE1076, 1868, 1879, D931, 3731, 3735, X095, 779, 668, R31706	1
R31706	3/4	4.70	2/1075	REV.PLUG	5.60	6.5"x1/2"	12.5/370	BALL	GENERAL REPLACEMENT	1
R22168	3/4	5.20	2/1075	REV.PLUG	5.60	6.5"x1/2"	15/370	SLEEVE	GENERAL REPLACEMENT	1

Rotation determined opposite shaft end
Double shaft determined at lead end

Shaft length measured from hub
face to shaft end

5.5" Motors



Double Shaft - 208/230 Volts

Sleeve & Ball Bearing - PSC & Shaded Pole - Open & Totally Enclosed.

Motors



Fig.1
R52639
R770
R52430

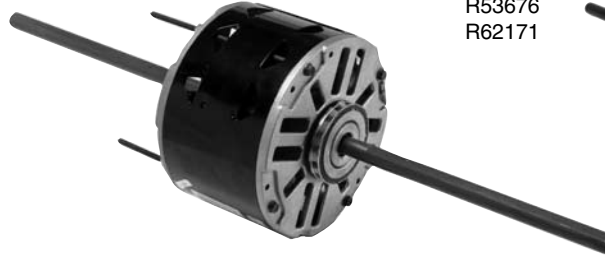

Fig.2
R52118
R52100
R52113
R53676
R62171

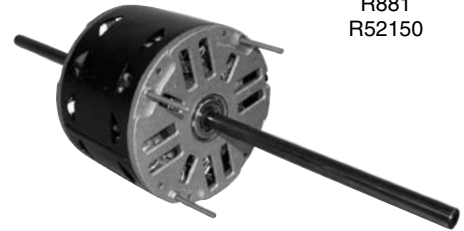

Fig.3
R858
R881
R52150



Fig.4
R52430



Fig.5
R52170

Part #	HP	Amps	Spd/ RPM	Rot	Body	Shaft	Cap	Encl.	Bearing	Comment	Fig.
R52100	1/8	1.00	3/1075	C.C.W.	4.00	7.8"x1/2"x8.5"	5/370	OPEN	SLEEVE	U.E.100, FASCO D750, MARATHON X057, X065	2
R52639	1/6	0.80	5/1075	C.C.W.	4.00	2.5"x1/2"x3.7"	4/370	T.E.	SLEEVE	CARRIER HC37CA230, HC37CA700, HC37CB208	1
R858	1/6	0.90	3/1100	C.C.W.	3.70	3.0"x1/2"x4.3"	5/370	OPEN	SLEEVE	FASCO D858, U.E. 115	3
R52118	1/6	0.95	3/1075	C.C.W.	3.80	8.0"x1/2"x8.2"	5/370	OPEN	SLEEVE	WJ94X504,50,54,47,162, 159,152, U.E.118, 438	2
R770	1/5	1.70	3/1040	C.W.	3.50	2.0"x1/2"x6.2"	3/370	T.E.	SLEEVE	KEEPRITE 128575	1
R52113	1/4	1.50	3/1075	C.C.W.	4.11	7.5"x1/2"x8.0"	5/370	OPEN	SLEEVE	U.E. 113, 439, FASCO D766	2
R52430	1/4	1.50	3/1060	C.W.	4.50	4.1"x1/2"x4.7"	7.5/370	OPEN	SLEEVE	McQUAY 24303	4
R53676	1/4	1.50	3/1075	C.C.W.	4.11	7.5"x1/2"x8.0"	5/370	OPEN	SLEEVE	NO MOUNTING KIT	2
R62171	1/4	1.80	3/1625	C.C.W.	4.30	7.5"x1/2"x8.0"	5/370	OPEN	SLEEVE	FASCO D774, D775, D896, U.E.171, MARATHON X040, X059	2
R52150	1/4	2.00	3/1025	C.W.	4.30	4.5"x1/2"x4.2"	7.5/370	OPEN	SLEEVE	SINGER 02024246	3
R52170	1/4	2.10	1/1725	REV	7.00	5.5"x1/2"x5.5"	SP	O.D.	SLEEVE	CHROMALOX 07589, GE 7J399GX, MARATHON 48S17D1240	5
R881	1/4	2.20	3/1075	C.C.W.	3.87	2.5"x1/2"x4.1"	5/370	OPEN	SLEEVE	FEDDERS S196582, FASCO D881, U.E.180, 181	3

Motors continued next page

Double Shaft - 208/230 Volts

Motors continued from previous

Sleeve & Ball Bearing - PSC - Open & Totally Enclosed

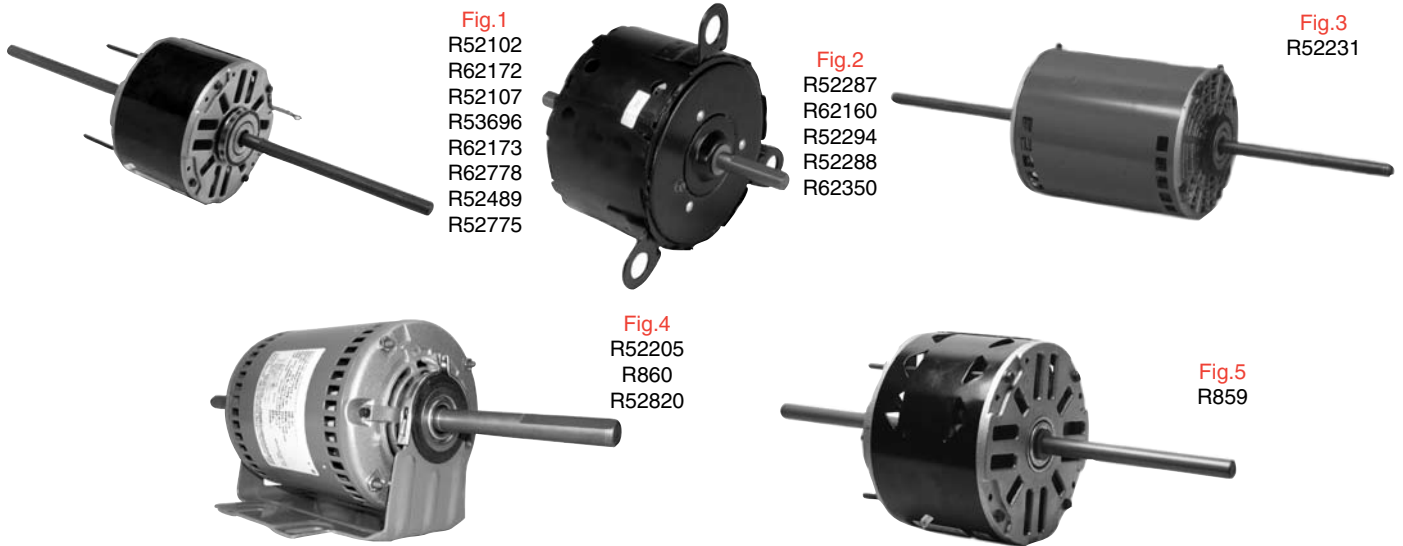

Fig.1
R52102
R62172
R52107
R53696
R62173
R62778
R52489
R52775

Fig.2
R52287
R62160
R52294
R52288
R62350

Fig.3
R52231

Fig.4
R52205
R860
R52820

Fig.5
R859

Part #	HP	Amps	Spd/ RPM	Rot	Body	Shaft	Cap	Encl.	Bearing	Comment	Fig.
R859	1/3	1.50	3/1100	C.C.W.	3.90	5.5"x1/2"x5.3"	5/370	OPEN	SLEEVE	FASCO D859, U.E. 116	5
R62350	1/3	1.80	5/1075	C.C.W.	4.85	2.4"x1/2"x2.8"	5/370	T.E.	SLEEVE	U.E. 168, FASCO D868	2
R52102	1/3	1.90	3/1075	C.C.W.	4.70	7.2"x1/2"x8.1"	5/370	OPEN	SLEEVE	396P011, 846A800G24, U.E.102, FASCO D1853	1
R62172	1/3	2.50	3/1625	C.C.W.	4.75	7.5"x1/2"x7.8"	5/370	OPEN	SLEEVE	1130033, U.E.110, 172, 399, FASCO D771, D891	1
R52287	1/3	2.90	3/1310	C.W.	4.50	2.4"x1/2"x2.9"	5/370	OPEN	SLEEVE	CHRYSLER, AIRTEMP H32H0007N, FASCO D808	2
R62160	1/3	3.00	3/1365	C.C.W.	4.40	2.9"x1/2"x4.3"	3/370	OPEN	SLEEVE	FASCO D854	2
R52107	1/2	2.70	3/1075	C.C.W.	5.10	7.7"x1/2"x6.2"	7.5/370	OPEN	SLEEVE	U.E. 107,121,468,473,544,FASCO D760,D860,D862,D873	1
R53696	1/2	2.70	3/1075	C.C.W.	5.61	7.7"x1/2"x7.2"	7.5/370	OPEN	SLEEVE	GEN. REPLACEMENT	1
R52294	1/2	3.20	3/1075	C.C.W.	5.00	7.0"x1/2"x2.8"	7.5/370	OPEN	SLEEVE	CARRIER HC43CE230, GE 5KCP39MGB284BS	2
R52288	1/2	3.80	3/1125	C.W.	4.80	4.0"x1/2"x3.0"	5/370	OPEN	SLEEVE	FEDDERS S196-170-6, FASCO D885, NORGE 21-3197	2
R52231	1/2	4.00	2/1075	REV. PLUG	7.00	6.5"x1/2"x6.4"	7.5/370	OPEN	SLEEVE	AMANA, RHEEM, LUXAIRE, MARATHON X231	3
R62173	1/2	4.10	3/1625	C.C.W.	5.25	7x1"/2x7".9"	5/370	OPEN	SLEEVE	FRANKLIN 80491, U.E. 108,173, FASCO D772, D866	1
R52775	1/2	4.30	1/1050	C.W.	5.25	9.3"x1/2"x9.3"	5/370	OPEN	SLEEVE	YORK 24-17775-000	1
R52205	3/4	3.60	1/1075	C.C.W.	8.60	7.0"x5/8"x4.5"	15/370	OPEN	BALL	EMERSON K2328, W.W.G. 3M825,TRANE MOT6291, FEDDERS	4
R62778	3/4	3.80	3/1625	C.C.W.	5.61	7.3"x1/2"x7.1"	7.5/370	OPEN	SLEEVE	FASCO D778	1
R860	3/4	3.90	1/1075	C.C.W.	8.60	7.0"x5/8"x7.0"	15/370	OPEN	BALL	STEVECO S3100, WHIRLPOOL, SEARS	4
R52820	3/4	4.20	3/1075	C.W.	7.80	5.3"x5/8"x4.8"	10/370	O.D.	BALL	LENNOX	4
R52489	3/4	5.40	3/1075	C.C.W.	5.50	6.8"x1/2"x7.5"	7.5/370	OPEN	SLEEVE	U.E. 489, FASCO D763	1

Rotation determined opposite shaft end
Double shaft determined at lead end

Shaft length measured from hub
face to shaft end

5.5" Motors



Single Shaft - 460 Volts

Sleeve & Ball Bearing - PSC - Open & Totally Enclose

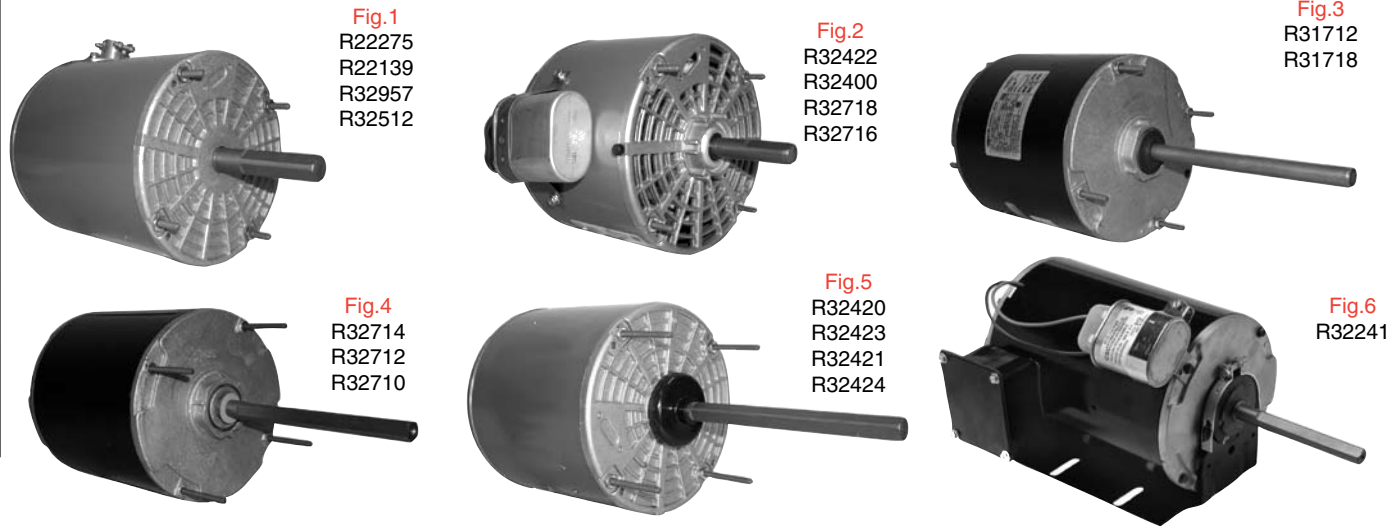

Fig.1
R22275
R22139
R32957
R32512

Fig.2
R32422
R32400
R32718
R32716

Fig.3
R31712
R31718

Fig.4
R32714
R32712
R32710

Fig.5
R32420
R32423
R32421
R32424

Fig.6
R32241

Part #	HP	Amps	Volt	Spd/RPM	Rot.	Bearing	Body	Shaft	Cap	Encl.	Comment	Fig.
R31710	1/4	0.75	460	1/1075	REV.PLUG	BALL	4.80	6.0"x1/2"	7.5/370	T.E.	CARRIER HC39VE462,HC40GE460, HC41AE460	3
R22275	1/4	0.80	460	1/850	C.W.	SLEEVE	4.80	2.9"x1/2"	5/370	T.E.	YORK 024-27501-000	1
R32420	1/4	1.00	460	1/1625	REV.PLUG	BALL	4.00	6.0"x1/2"	5/370	S.E.	FASCO D918, MARATHON X420	5
R32423	1/4	1.00	460	1/1075	REV.	BALL	4.30	6.0"x1/2"	5.0/370	T.E.	GEN. REPLACEMENT	5
R32710	1/4	1.20	460	2/1625	REV.	BALL	4.40	6.4"x1/2"	5/370	S.E.	TRANE WW94X252,259,263, 418,TFM1864, R4111P517	4
R31712	1/3	0.90	460	1/1075	REV.PLUG	BALL	5.30	6.0"x1/2"	7.5/370	T.E.	CARRIER HC40MB549, EMERSON 6523	3
R32714	1/3	10.00	460	1/825	REV.	BALL	5.60	6.4"x1/2"	10/370	S.E.	GENERAL REPLACEMENT	4
R32712	1/3	1.20	460	2/1075	REV.	BALL	4.70	6.4"x1/2"	7.5/370	S.E.	HC39SE460,GE640, 5001P,5016T24-18412-003, TRANE WW94X410	4
R32421	1/3	1.30	460	1/1625	REV.PLUG	BALL	4.50	6.0"x1/2"	5/370	S.E.	FASCO D916	5
R32424	1/3	1.40	460	1/1075	REV.PLUG	BALL	4.80	6.0"x1/2"	7.5/370	S.E.	FASCO D912MARATHON X424	5
R31718	1/2	1.15	460	1/1050	REV.PLUG	BALL	5.30	3.3"x1/2"	10/370	T.E.	VERTICAL UP	3
R22139	1/2	1.30	460	1/1090	C.W.	SLEEVE	5.00	3.4"x1/2"	7.5/370	T.E.	YORK 024-24110-702	1
R32512	1/2	1.50	460	1/1100	C.C.W.	BALL	8.30	4.8"x1/2"	5/440	OPEN	UE 151015, H3TO27, 02419512, 151015, H3TO27141015	1
R32422	1/2	1.70	460	1/1625	REV.PLUG	BALL	5.00	6.0"x1/2"	7.5/370	S.E.	FASCO D916	2
R32400	1/2	1.80	460	1/1075	REV.	BALL	1.00	6.0"x1/2"	10/370	T.E.	VERTICAL UP	2
R32718	1/2	1.80	460	2/1625	REV.	BALL	5.20	6.4"x1/2"	7.5/370	S.E.	FASCO D916	2
R32716	1/2	1.90	460	2/1075	REV.	BALL	5.50	6.4"x1/2"	10/370	S.E.	U.E.435,CARRIER,YORK, TRANE WW94X315, R4131P516	2
R32957	1/2	2.00	460	1/1075	C.C.W.	BALL	7.50	4.3"x1/2"	5/370	OPEN	YORK 024-183957-00	1
R32241	1/2	4.00	208/230/460	1/1075	REV.	BALL	7.70	4.5"x1/2"	INC.	OPEN	DUNHAM BUSH MTR-226	6

Motors continued next page

www.rotom.ca

Shaft length measured from hub
face to shaft end

Rotation determined opposite shaft end
Double shaft determined at lead end

Single Shaft - 460 Volts

Motors continued from previous

Sleeve & Ball Bearing - PSC - Open & Totally Enclosed

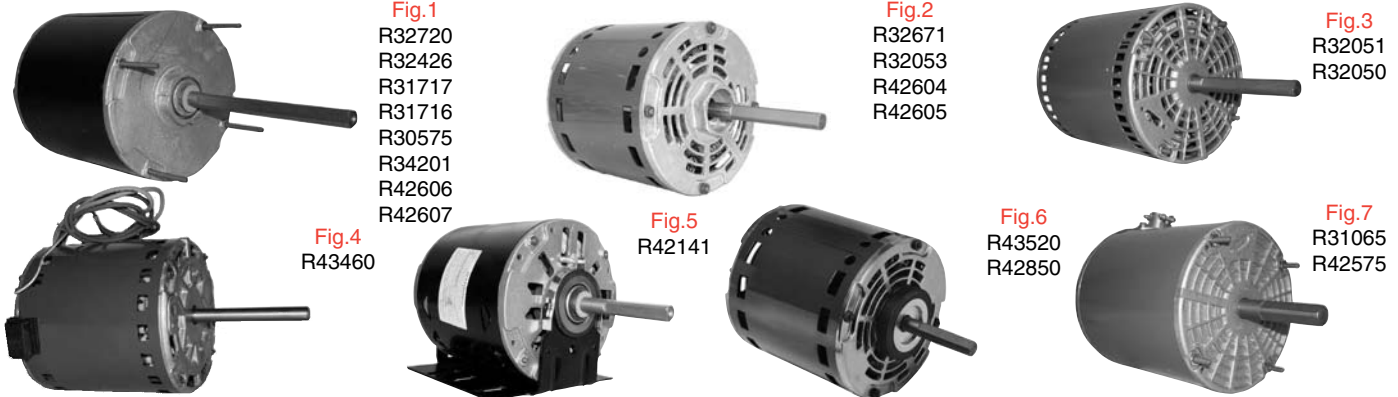

Part #	HP	Amps	Volt	Spd/RPM	Rot.	Bearing	Body	Shaft	Cap	Encl.	Comment	Fig.
R31717	3/4	1.90	460	2/1075	REV.PLUG	BALL	6.10	6.0"x1/2"	10/370	T.E.	ALL ANGLE CARRIER	1
R32671	3/4	2.10	460	3/1050	C.C.W.	BALL	5.30	4.0"x1/2"	12.5/370	OPEN	YORK 024-21671-000	2
R32051	3/4	2.15	460	3/1075	REV.PLUG	BALL	6.63	4.0"x1/2"	15/370	OPEN	YORK, THERMOPLUS, LENNOX, CARRIER	3
R32720	3/4	2.20	460	2/1075	REV.	BALL	5.50	6.4"x1/2"	15/370	S.E.	CARRIER HC45MF460, U.E.158,FASCO D704,	1
R32426	3/4	2.20	460	1/1075	REV.	BALL	5.50	4.5"x5/8"	7.5/370	OPEN	VERTICAL UP	1
R31716	3/4	2.50	460	1/1075	REV.PLUG	BALL	6.10	6.0"x1/2"	10/370	T.E.	FASCO D1914, MARATHON X099	1
R43520	3/4	2.00	460	3/1075	C.C.W	BALL	6.00	2.5"x1/2"	20/370	OPEN	LENNOX 43G5201	6
R43460	1	2.50	460	3/1100	C.C.W.	BALL	6.50	4.0"x1/2"	25/370	OPEN	YORK 0242500001	4
R32053	1	3.00	460	3/1100	C.C.W.	BALL	7.00	4.0"x1/2"	25/370	OPEN	YORK 024-25000D004-001	2
R42850	1	3.20	460	3/1100	REV.PLUG	BALL	6.10	4.5"x1/2"	15/370	OPEN	GENERAL REPLACEMENT	6
R42141	1	7.60	208/230/460	1/1075	REV.	BALL	8.50	4.0"x1/2"	INC.	OPEN	KRAMER DD661, DD791	5

Single Shaft 575 Volts

Part #	HP	Amps	Volt	Spd/RPM	Rot.	Bearing	Body	Shaft	Cap	Encl.	Comment	Fig.
R30575	1/6	0.50	575	1/1625	REV.	SLEEVE	4.50	2.2"x1/2"	INC.	OPEN	MARATHON A48170246A,HUSSMAN 077228, CMS 30575	1
R34201	1/5	0.50	575	1/1075	C.W.	SLEEVE	4.50	2.5"x1/2"	INC.	OPEN	UE HA3J010, HA3J036, HUSSMAN 204201, CMS 30125	1
R31065	1/4	0.50	575	1/1140	REV.	BALL	6.30	2.8"x5/8"	-	T.E.	KEEPRITE 171065, U.E. HM3G004K	7
R42604	1/3	1.50	575	1/1100	REV.PLUG	BALL	5.80	6.0"x1/2"	7.5/440	T.E.	TRANE MOT2604, LENNOX 25G20	2
R42605	1/2	1.00	575	1/1625	REV.PLUG	BALL	5.60	6.0"x1/2"	7.5/440	T.E.	TRANE M02605, CENTURY 173329MAGNETEK HF2J043	2
R42575	1/2	1.80	575	1/1140	REV.	BALL	7.90	2.5"x1/2"	7.5/440	S.E.	CARRIER HD44ML461,AO SMITH P48J6A2	7
R42606	1/2	1.20	575	1/1100	REV.PLUG	BALL	5.50	6.0"x1/2"	7.5/370	T.E.	TRANE, COMFORTAIRE	1
R32050	3/4	1.65	575	3/1024	REV.PLUG	BALL	6.50	4.0"x1/2"	15/370	OPEN	YORK, THERMOPLUS, LENNOX, CARRIER	3
R42607	3/4	1.90	575	1/1075	REV.PLUG	BALL	6.00	6.0"x1/2"	15/370	T.E.	CENTURY HM3T071, TRANE,MOT2607, MARATHON 48A11T566	1

Rotation determined opposite shaft end
Double shaft determined at lead end

Shaft length measured from hub
face to shaft end

5.5" Direct Drive Motors

- **Less Inventory Required!**
- **Versatile!**
- **Time Saver!**
- **Easy Installations!**

Replaces:
 Lennox 76N17
 GE Mars 03463
 Emerson 5460
 Rheem-Ruud 51-23012-41

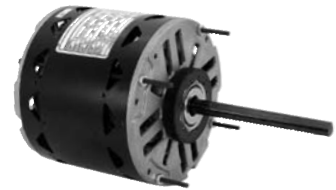

Features

- Energy Efficient
- Different Capacitor/Speed Combos
- Designed for 370V Cap (not incl.)
- Permanent Split Capacitor
- Ball and Sleeve Bearing
- Reversible Rotation
- Resilient Rings
- Extended Thru Bolts
- Automatic Protector
- Class B Insulation
- 48 Frame
- Single Phase
- Continuous Duty-Over Air
- Mounts by Belly Band, Thru Bolts or Shell Holes
- Rheem Mounting Holes in Shell
- 60 Hz

Part #	HP	Spd.	RPM	Volt	Amps	Capacitor (370V)		Bearing	Leads	Dia	Shaft	
R43600	1/2	All	1075	115	7.0	10 mfd		Sleeve	26"	4.86"	1/2"x5"	
	1/3	All			6.7	5	mfd					7.5*
	1/4	Lo, Med-Lo, Med-Hi			4.4							
	1/5	Low, Med-Lo			3.2							
	1/6	Lo			2.4							
R43601	1/2	All	1075	208-230	3.9	10 mfd		Sleeve	26"	4.86"	1/2"x5"	
	1/3	All			3.6	5	mfd					7.5*
	1/4	Lo, Med-Lo, Med-Hi			2.5							
	1/5	Lo, Med-Lo			1.8							
	1/6	Lo			1.3							
R43602	3/4	All	1075	115	9.1	10 mfd		Ball	38"	4.86"	1/2"x5 1/2"	
	1/2	All			6.8	5	mfd					7.5*
	1/3	All			5.5							
	1/4	Lo, Med-Lo, Med-Hi			3.0							
	1/5	Lo, Med-Lo			2.3							
R43603	3/4	All	1075	208-230	3.9	10 mfd		Ball	38"	4.86"	1/2"x5 1/2"	
	1/2	All			3.6	5	mfd					7.5*
	1/3	All			3.0							
	1/4	Lo, Med-Lo, Med-Hi			2.3							
	1/5	Lo, Med-Lo			2.0							

* Motor approximately 10% stronger & has higher starting torque for 1/6, 1/5, 1/4 & 1/3 HP rating with the 7.5 mfd 370VAC capacitor.

Condenser Fan Multi HP

Part #	HP	Spd.	RPM	Volt	Amps	Cap. (370V)		Bearing	Leads	Dia.	Shaft	
						208V	230V					
R22601	1/3	High	825	208-230	1.9	10	mfd	7.5	Ball	36"	5.24"	1/2"x5"
	1/4				1.5							
	1/5	Low			1.2							
	1/6				1.0							
	1/2				2.4							
R22603	1/2	High	825	208-230	1.7	12.5	mfd	10	Ball	36"	5.61"	1/2"x6"
	1/3				1.4							
	1/4	Low			1.1							
	1/5				1.1							
	1/6				1.1							
R22600	1/3	High	1075	208-230	2.8	7.5	mfd	5	Sleeve	36"	4.86"	1/2"x6"
	1/4				2.0							
	1/5	Low			1.7							
	1/6				1.5							
	1/2				2.8							
R22605	1/3	High	1075	208-230	2.0	7.5	mfd	5	Ball	36"	4.86"	1/2"x6"
	1/4				2.0							
	1/5	Low			1.7							
	1/6				1.5							
	1/2				3.9							
R22602	1/2	High	1075	208-230	3.9	12.5	mfd	10	Ball	36"	5.24"	1/2"x5"
	1/3				2.2							
	1/4	Low			1.6							
	1/5				1.3							
	1/6				1.3							
R22604	3/4	High	1075	208-230	5.3	15	mfd	12.5	Ball	36"	5.87"	1/2"x6"
	1/2				3.0							
	1/3	Low			1.9							
	1/4				1.0							
	1/6				1.0							

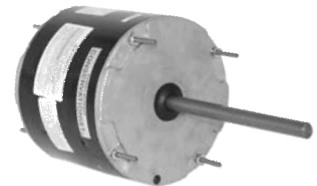

Features

- **LESS INVENTORY REQUIRED!**
- **VERSATILE!**
- **TIME SAVER!**
- **EASY INSTALLATIONS!**
- Totally Enclosed
- Energy Efficient
- Different Capacitor/Speed Combos
- Designed for 370V Cap (not incl.)
- Permanent Split Capacitor
- Ball and Sleeve Bearing
- Reversible Rotation
- Resilient Rings (Direct Drive)
- Extended Thru Bolts
- Automatic Protector
- Class B Insulation
- 48 Frame
- Single Phase
- Continuous Duty-Over Air
- Mounts by Belly Band, Thru Bolts or Shell Holes
- Rheem Mounting Holes in Shell
- 60 Hz

**Totally Enclosed
 Air Over
 60°C Ambient**

Shaft length measured from hub face to shaft end

Rotation determined opposite shaft end
 Double shaft determined at lead end

4.0" Diameter Electric Unit Heaters

115 Volt - Open - CCW Lead End Rotation

Comment: Magnetek #78

Part #	HP	Amps	RPM	Shaft
R2614	1/12	2.25	1550	2.0" x 3/8"



5.0" Diameter - OEM Replacement

OEM Direct Replacements - Totally Enclosed - 115 Volts

Comment:

Direct Replacement for Reznor, Luxaire, *Lennox P8-6920, *Keeprite 54028, A0516, A2160, E62788, E62862, E62A15, *Robbin Myers.



Fig. B
Reznor

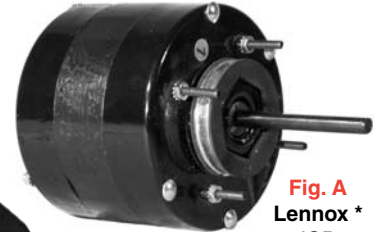

Fig. A
Lennox *
ICP
Keeprite

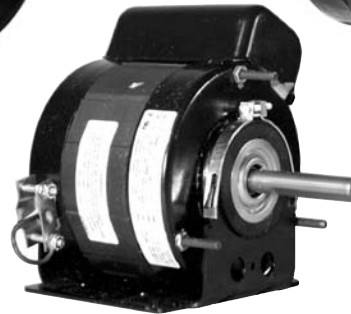
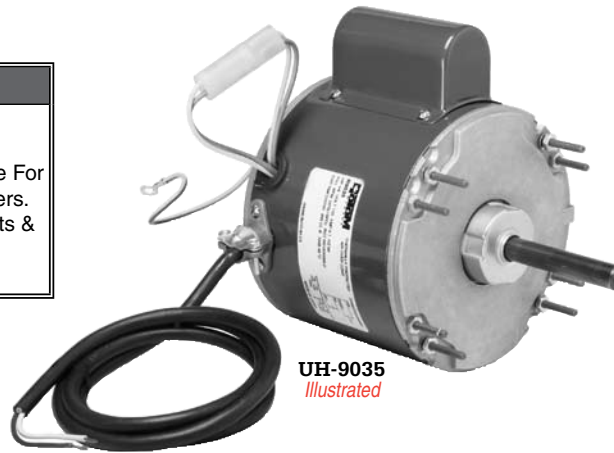

Fig. C
Robbin Myers
Reznor

Part #	Fig.	HP	RPM	Type
R6920*	A	1/15	1050	SP
R2360	B	1/15	1050	SP
R2615	B	1/8	1050	SP
R2380	C	1/8	1075	PSC/INC

5.5" Diameter Unit Heater Motors

Optional Base	
	<p>UH-UHK Optional Mounting Base For UH- Series Unit Heaters. Includes Base, Brackets & Resilient Rings.</p>



UH-9035
Illustrated

Features

- 48 Frame
- 5.5" Diameter
- Totally Enclosed
- Mounting: 4/8 Stud. Pattern
- 60 Hz
- Ball Bearing
- Shaft: 1/2" x 3.4"
- Reversible
- Permanent Split Capacitor (P.S.C.)
- 40" Black Water Resistant SJOW Cord
- 45°C (113°F) Ambient
- Insulation Class B
- Thermally Protected

Unit Heater



Part #	HP	Volts	Amps	Cap.	RPM	Rotation	A Dim.	Bearing	Shaft
UH-9034	1/6	115	2.4	4/370	1/1075	REV.PLUG	4.55"	Ball	1/2"x3.4"
UH-9035	1/4	115	4.1	5/370	1/1075	REV.PLU	4.52"	Ball	1/2"x3.4"
UH-9036	1/3	115	5.0	7.5/370	1/1075	REV.	4.52"	Ball	1/2"x3.4"

Capacitor Included

Comment

Rotom	AO Smith	Emerson	Fasco	GE	Marathon	UE
UH-9034	UH1016, US1016, US1016NB	9034	D834	3206	X302, X306	177, 749
UH-9035	UH1026, US1026, US1026NB	9035	D734	3208	X303, X307	566, 734, 750
UH-9036	UH1036, US1036, US1036NB	9036	D732	3212	X304, X308	183, 751

Rotation determined opposite shaft end
Double shaft determined at lead end

Shaft length measured from hub face to shaft end

Ball Bearing

Unit Heater / Oil Burner



5.5" Diameter Unit Heater Motors

Motors

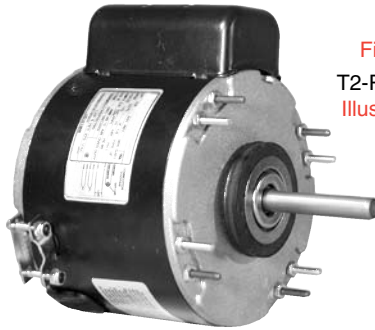

Fig. E
T2-R12677
Illustrated

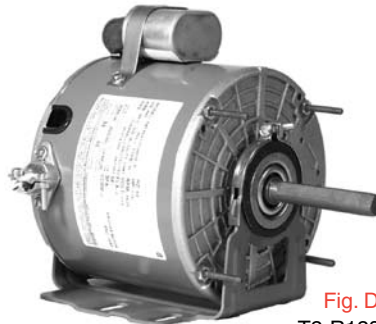
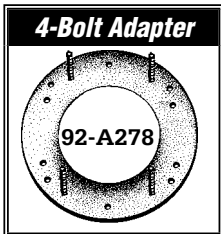

Fig. D
T2-R12835
Illustrated

- 48 Frame • Totally Enclosed
- 115 Volt • Reversible • PSC

Part #	Fig.	HP	RPM	Bearing
R12178	D	1/6	1625	Sleeve
R12835	D	1/6	1625	Ball
R12177	D	1/6	1075	Sleeve
R12677	E	1/6	1075	Sleeve
R12834	D	1/6	1075	Ball
R12486	D	1/4	1075	Sleeve
R12686	E	1/4	1075	Sleeve
R12586	D	1/4	1075	Ball
R182	D	1/3	1075	Sleeve
R12682	E	1/3	1075	Sleeve
R183	D	1/3	1075	Ball
A278	4-Bolt Clare/ Fedders Adapter Plate			

Oil Burner

- Residential and Commercial
- Reversible
- Split Phase



T4-R2097
Illustrated

Part #	HP	Volts	Amps	RPM	Frame
R6102	1/8	115	2.50	1725	48N
R2097	1/8	115	2.40	3450	48N
R3083	1/7	115	2.50	3450	48M
R3250	1/6	115	3.20	1725	48N
R3251	1/6	115	2.70	3450	48M
R2304	1/5	115/230	3.00	3450	48N
R3579	1/4	115	4.20	1725	48N
R2302	1/4	115	4.84	3450	48N
R2303	1/3	115	5.00	1725	48N
R2211	1/3	115/208/230	5.60	3450	48
R2305	1/3	115/230	5.60	3450	48N
R2213	1/2	115/208/230	7.40	3450	56C
R2306	1/2	115/230	7.40	3450	48N
R2215	3/4	115/208/230	9.80	3450	56C
R2217	1	115/208/230	9.80	3450	56C
R2231	1 1/2	115/208/230	13.40	3450	56C
R2232	2	115/208/230	19.20	3450	56C

Oil Burner - Beckett PSC Motor

- More Reliable
- Fewer Service Calls
- 4 Year Warranty
- 48 M Frame



Beckett 21805U Replacement

Part #	HP	Volts	Type	RPM	Rotation
R21805U	1/7	115	PSC	3450	CCW

Shaft length measured from hub face to shaft end

Rotation determined opposite shaft end
Double shaft determined at lead end

Single Speed Belted Fan Motors



**Ball Bearing
Commercial Ventilation!
BF-4707 (1/3 HP)
BF-4709 (1/2 HP)**

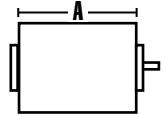

Motors

Single Speed

Part #	HP	Volts	Amps	S.F.	RPM	Rotation	A Dim.	Bearing	Shaft
BF-4701	1/4	115	5.8	1.35	1/1725	Revers.	6.25"	Sleeve	1/2"x1.5"
BF-4706	1/3	115	7.3	1.35	1/1725	Revers.	6.25"	Sleeve	1/2"x1.5"
BF-4707	1/3	115	7.3	1.35	1/1725	Revers.	6.25"	Ball	1/2"x1.5"
BF-4708	1/2	115	9.9	1.25	1/1725	Revers.	6.75"	Sleeve	1/2"x1.5"
BF-4709	1/2	115	9.9	1.25	1/1725	Revers.	6.75"	Ball	1/2"x1.5"

Features

- 48 Frame
- 5.5" Diameter
- Open Drip Proof
- Resilient Ring & Base Included
- 60 Hz
- Ball & Sleeve Bearing
- Shaft: 1/2" x 1.5" W/ Flat
- Reversible
- Split Phase
- 45°C (113°F) Ambient
- Insulation Class B
- Thermally Protected

Cross Reference

Rotom	AO Smith	Emerson	Fasco	GE	Marathon	UE	Rotom
BF-4701	GF2024	840CV	D6002	4701, H701	D127, B206, B303	-	R840
BF-4706	GF2034	841CV	-	4706, H711	D143, B207	-	R841
BF-4707	GF2034B	2888	D6004	4682, H165	B305, B703	906, 921, 922	R2888
BF-4708	GF2054	1542C	-	4708	D162, B208	-	R5794
BF-4709	-	2887	D6006	4684, H703	B307	-	R2887

Two Speed Belted Fan



- Reversible
- Shaded Pole & Split Phase
- Resilient Ring & Base Included

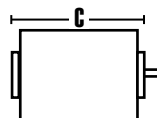

Part #	HP	Volts	Amps	S.F.	RPM	Type	C Dim.	Fr.	Bearing	Shaft
R5793	1/3	115	6.7	1.35	2/1725	SPLT/ ODP	8.30"	56Z	Sleeve	1/2"x1.6"
R5794	1/2	115	7.20	1.25	2/1725	SP/ Open.	9.9"	48/56	Sleeve	1.5"x1/2"

Part #	Comment
R5793	Emerson 5793, K5793, U.E. 849, G.E. 5J765GS
R5794	B200, D149, D162, S121, 1542, 7J403AS, 7J403AX

*5/8" Thru-bolts shaft end.

Rotation determined opposite shaft end
Double shaft determined at lead end

Shaft length measured from hub
face to shaft end

Air Compressor Motors

Single Phase - Reversible - Ball Bearing - Drip Proof - Rigid Base - 1.0 SF - Manual Protection

Part #	HP	Amps	Volts	Spd/RPM	Frame	Body	Shaft	Comments
S1400	3/4	12.5	115/230	1/3450	56	8.60	1.9"x5/8"K	-
S1402	1	15.0	115/230	1/3450	56	9.10	1.9"x5/8"K	-
S1404	1 1/2	15.0	115/230	1/3450	56	9.10	1.9"x5/8"K	DUAL CAPACITOR
S1406	2	24.0	115/230	1/3450	56	10.10	1.9"x5/8"K	-
S1408	3	15.0	208/230	1/3450	56	11.10	1.9"x5/8"K	DUAL CAPACITOR
S1410	5	22.0	208/230	1/3450	56HZ	11.12	2.3"x7/8"	DUAL CAPACITOR



Carbonator Pump Motors

Split Phase - Sleeve Bearing - CCW - Drip Proof - Resilient Base - 1.0 SF - Auto Protection

Part #	HP	Amps	Volts	Spd/RPM	Frame	Body	Shaft	Comments
R2024	1/4	5.8	115	1/1725	48Y	7.80	0.531"x1/2"	-
R2025	1/4	4.0	115/230	1/1725	48Y	8.10	0.531"x1/2"	50/60 HZ
R2034	1/3	6.2	115	1/1725	48Y	8.10	0.531"x1/2"	-
R2035	1/3	4.6	115/230	1/1725	48Y	8.10	0.531"x1/2"	50/60 HZ
R2054	1/2	6.8	115/230	1/1725	48Y	8.10	0.531"x1/2"	50/60 HZ



Commercial & Industrial Fan & Blower Exhaust Ventilators Motors

Split Phase - Single Phase - Ball Bearings - Drip Proof - Reversible - NEMA Service Factor

Part #	HP	Amps	Volts	Spd/RPM	Frame	Shaft	Comments
S3800	1/6	3.3	115	1/1140	56CZ	2.1"x5/8"	CLASS A INSULATION
S3810	1/4	5.0	115	1/1140	56CZ	2.1"x5/8"	CLASS A INSULATION



Poultry / Barn Fans

Split Phase - Single Phase - Ball Bearings - Drip Proof - Reversible - NEMA Service Factor

Part #	HP	Amps	Volts	RPM	Body	Shaft	Comment
S9030	1/4	3.50	115	1/1725	7.60	2.9"x1/2"	MARATHON X903C/W 5/8"K ADAPTER
S9040	1/3	4.50	115	1/1725	7.50	2.9"x1/2"	MARATHON X904C/W 5/8"K ADAPTER
S9000	1/2	6.60	115/230	1/1725	7.50	1.6"x1/2"K	AGRICULTURE FAN APPLICATIONS C/W 5/8" ADAPTER

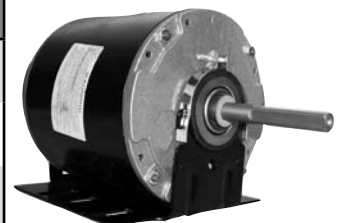

Tempspec Fan Coil Motors

Comment: UE & Tempspec DE3E142N

Part #	HP	Volts	Amps	Type	Cap.	RPM	Rot.	Body	Frame	Bearing	Shaft
R2197	1/14	115	1.25	PSC/ Open	7.5/370	3/820	CCW	3.8"	5.0"	Sleeve	3.4"x1/2"
R2198	1/14	115	1.25	PSC/ Open	7.5/370	3/820	CCW	3.8"	5.0"	Sleeve	3.4"x1/2"



M4-R2198

M4-R2197

With 92-A8551 8.37" bracket

Comment: M4-R2194 Tempspec DE3E141N
M4-R2195 Tempspec DE3F056N
M4-R2196 Tempspec DE3G110N

9" or 10" Bolt Circle

Part #	HP	Volts	Amps	Type	Cap.	RPM	Rot.	Body	Frame	Bearing	Shaft
R2194	1/14	115	1.25	PSC/ Open	7.5/370	3/820	CCW	4.0"	5.0"	Sleeve	3.4"x1/2"
R2195	1/12	115	2.10	PSC/ Open	7.5/370	3/740	CCW	4.6"	5.0"	Sleeve	3.4"x1/2"
R2196	1/8	115	2.50	PSC/ Open	7.5/370	3/850	CCW	4.5"	5.0"	Sleeve	3.9"x1/2"

M4-R2195

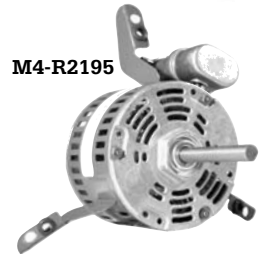

Fan Coil Motors

Heating & Air Conditioning • High Rise Apartment • Condominium • Hotel
ONE MOTOR DOES ALL THREE! Bedroom, Living Room, Common Area.

5KCP39DGV279S

Comment: UE799, L350, L450, L600, UE DA3E200, DA3F100, DA3G142, R2299

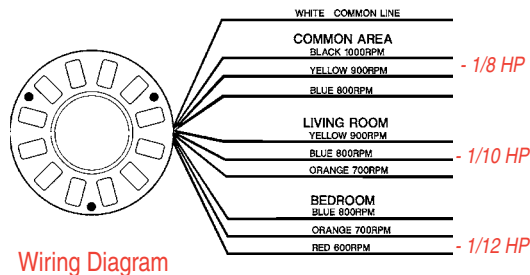

Wiring Diagram

3 in 1
• 1/8 HP • 1/10 HP •
1/12 HP • 1000 RPM
• 115V • 5 Speed •
4.3" x 1/2" Shaft

Direct Replacement For:

- Climetec
- Snyder-General
- Tempspec
- Unilux

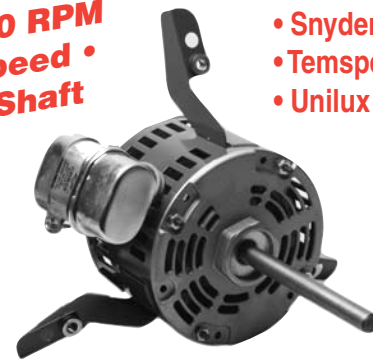

Part #	HP	Amps	Cap.	RPM	Body	Shaft
DD-029	1/8	2.10	Inc.	5/1000	3.61"	1/2"x5.0"
DD-030	1/6	2.6	Inc.	5/950	3.57"	1/2"x4.5"

Fan Coil Blowers

Heating & Air Conditioning • High Rise Apartment • Condominium • Hotel

Part #	CFM	"A" Dim.
66-RFC300	300	6.75"
66-RFC400	400	8.25"
66-RFC600	600	9.0"

Applications

- Heating & Air Conditioning
- High Rise Apartment
- Condominium
- Hotel



Thermo Aqua Stats

Thermo Aqua Stats

Part #	Description	Specifications	Wires	Cross Ref
18-DT2-85	3 Wire Change Over Thermostats	Opens 83°F	2 term. Heating Only 54" x 5/8" mount.	37T31
18-DT3-85		Closes 65°F	3 term. Heating & Cooling 54" x 5/8" mount.	37T33

Replaces

- Unilux
- Tempspec
- Climetec
- Snyder-General



Rotation determined opposite shaft end
Double shaft determined at lead end

Shaft length measured from hub
face to shaft end

Circulator Pump



Circulator Pump

Single Shaft • Single Speed • Sleeve & Ball Bearing • 1725 RPM

115/230/460/575 Volts • Resilient Rings for Base Mount Models • Open Construction • Reversible

Typical Applications : Hot Water Boiler & Booster Pumps

Sleeve Bearing Models Feature Easy Access Oilers!



Fig.1



Fig.2



Fig.3

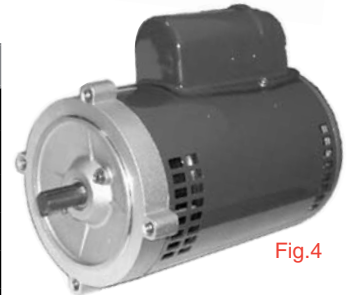

Fig.4



Fig.5



Fig.6

Part #	HP	Volts	Fig.	Bearing	Armstrong	B & G
CP-R1350	1/12	115	1	Sleeve	805316-010, 831000-61	111034
CP-R1352	1/6	115	1	Sleeve	817025-001, 831001-061	111031
CP-R1354	1/4	115	1	Sleeve	817025-007, 831002-061	111040
CP-R1444		115	2	Sleeve	816141-001	
CP-R1356	1/3	115	1	Sleeve	817025-013, 831003-061	111042
CP-R1446		115	2	Sleeve	816141-002	
CP-R1359	1/2	115/230	4	Ball	831009-061	111044
CP-R1368		230/460	3	Ball	811757-003, 020, 023, 831011-083	111046
CP-R1369		575	3	Ball	811757-004	111046-5
CP-R1459	3/4	115/230	5	Ball	811757-001	111044
CP-R1362		115/230	4	Ball	831010-062	111047
CP-R1370		230/460	3	Ball	831012-083	111049
CP-R1372		575	3	Ball	811757-006	111049-5
CP-R1462	1	115/230	5	Ball	811757-002, 033	111047
CP-R1470		230/460	6	Ball	811575-005	111049
CP-R1472		575	6	Ball	811757-005, 024, 027	111049-5
CP-R1363	1	115/230	4	Ball	816676-062	111050
CP-R1371		230/460	3	Ball	816675-069	169090
CP-R1373		575	3	Ball	816676-068	169090-5
CP-R1463		115/230	5	Ball	811757-007, 028, 031	111050
CP-R1471		230/460	6	Ball	811757-008	169090
CP-R1473		575	6	Ball	811757-009, 028, 031	169090-5
CP-R1365	1 1/2	115/230	4	Ball	816678-062	169095
CP-R1374		230/460	3	Ball	816678-069	169092
CP-R1375		575	3	Ball	816685-068	196092-5

Pump Couplers

Easy Links - Spirolink



T6-10010



T6-10034

Part#	Specification	Description
T6-10010	1/2" x 1/2"	1/2 to 1/3 HP Easy Link
T6-10010SL	1/2" x 1/2"	Spirolink
T6-10023	1/2" x 1/2" or 1/2" x 5/8"	1/2 to 3/4 HP Easy Link
T6-10023SL	1/2" x 1/2" or 1/2" x 5/8"	Spirolink
T6-10034	1/2" x 5/8" or 5/8" x 5/8"	1 HP Easy Link
T6-10034SL	1/2" x 5/8" or 5/8" x 5/8"	Spirolink
T6-10045SL	1/2" x 5/8" or 5/8" x 5/8"	Taco

48 & 56 Frame Belted Fan Motors

Single Phase

Commercial & Industrial Blower Motors

- Electrically Reversible • Resilient Base • Automatic Overload
- Open Drip Proof • NEMA Mounting

TYPICAL APPLICATIONS: Pumps, Conveyors, Blowers Industrial Duty



Motors

120/230 Volts

Part #	HP	Amps	Volts	RPM	Frame	Body	Shaft	Bearing	Comment
R2890	1/6	3.60	115	1/1725	48	7.50	1.6"x1/2"	BALL	1.35 S.F.
S3830	1/4	4.10	115	2/1725	48	8.20	1.9"x1/2"	BALL	LENNOX 15N72, EMERSON 1785, 1.35 S.F.
R840	1/4	5.00	115	1/1725	48	6.50	1.6"x1/2"	SLEEVE	1.35 S.F.
R2889	1/4	5.00	115	1/1725	48	7.50	1.9"x1/2"	BALL	1.35 S.F.
S1101	1/4	5.00	115/230	1/1725	48	7.00	1.5"x1/2"	SLEEVE	1.0 S.F.
R940	1/4	5.30	115	1/1140	48	8.60	1.6"x1/2"	BALL	1.0 S.F.
R8402	1/4	2.50	230	1/1725	48	7.50	1.6"x1/2"	SLEEVE	1.35 S.F.
S1102	1/4	5.60	115/230	1/1725	48	7.50	1.6"x1/2"	SLEEVE	1.35 S.F.
S1100	1/3	3.80	115	1/1625	56	8.50	1.9"x5/8"K	BALL	LORD BURNHAM, LOUVER FANS, GREENHOUSE INSTANT REV.
R8412	1/3	3.10	230	1/1725	48	7.80	1.6"x1/2"	SLEEVE	1.35 S.F.
R841	1/3	5.90	115	1/1725	48	7.00	1.6"x1/2"	SLEEVE	RESIDENTIAL, 1.35 S.F.
R2888	1/3	6.10	115	1/1725	48	7.80	1.9"x1/2"	BALL	1.35 S.F.
S1108	1/3	5.60	115/208/230	1/1725	48	7.50	1.6"x1/2"	BALL	1.35 S.F.
S1120	1/3	6.40	115/208/230	1/1725	56	7.90	1.9"x5/8"K	BALL	1119,1664,2547,6011524, 1.35 S.F.
S1110	1/3	7.00	115/230	1/1725	48	1.00	1.5"x1/2"	SLEEVE	1.0 S.F.
S1112	1/3	6.20	115	1/1725	48	8.00	1.6"x1/2"	SLEEVE	1.35 S.F.
R5794	1/2	7.20	115	2/1725	48/56	9.90"	1.5"x1/2"	SLEEVE	B200,D149,D162,S121,1542, 7J403AS,7J403AX
R3022	1/2	7.20	115	1/1725	56	8.70	1.9"x5/8"K"	BALL	1.25 S.F.
R2887	1/2	7.20	115	1/1725	48	8.70	1.9"x1/2"	BALL	1.25 S.F.
S1130	1/2	4.10	115	1/3450	56	1.00	1.9"x5/8"K	BALL	1.25 S.F.
S1154	1/2	7.20	115/208/230	1/3450	56	9.00	2.0"x5/8"	BALL	BALDOR RL1303A, G.E. 4224R1231P124, 1.60 S.F.
S1156	1/2	7.20	115/208/230	1/1750	56	9.60	1.6"x5/8"	BALL	LENNOX P-8-3216, P-8-3265, P-8-4701, R1231P123 1.25 S.F.
S3890	1/2	8.10	115	2/1725	56	8.90	1.9"x5/8"K	BALL	1.25 S.F.
R5794	1/2	9.00	115	2/1725	56	7.50	1.6"x5/8"	SLEEVE	RESIDENTIAL, 1.35 S.F.
S1134	1/2	8.20	115/230	1/1725	56	1.00	1.9"x5/8"	SLEEVE	1.0 S.F.
S1450	1/2	3.40	208/230	1/825	56	8.60	6.1"x5/8"K	BALL	EMERSON K3568
S1132	1/2	8.60	115/230	1/1725	48	8.40	1.6"x1/2"	SLEEVE	CENTURY C133 1.0 S.F.
S1138	1/2	8.80	115/230	1/1725	56	8.10	1.9"x5/8"K	SLEEVE	312P417, G151, C607, M-252, 1.25 S.F.
S1146	1/2	9.60	115/230	1/1725	56	8.30	2.0"x5/8"K	BALL	3874, 601525, BALDOR CHC3524A, 1.25 S.F.

Rotation determined opposite shaft end
Double shaft determined at lead end

Shaft length measured from hub
face to shaft end

Blower Motors



56 Frame Belted Fan Motors

Single Phase

Commercial & Industrial Blower Motors

- Electrically Reversible • Resilient Base • Automatic Overload
- Open Drip Proof • NEMA Mounting

TYPICAL APPLICATIONS: Pumps, Conveyors, Blowers Industrial Duty

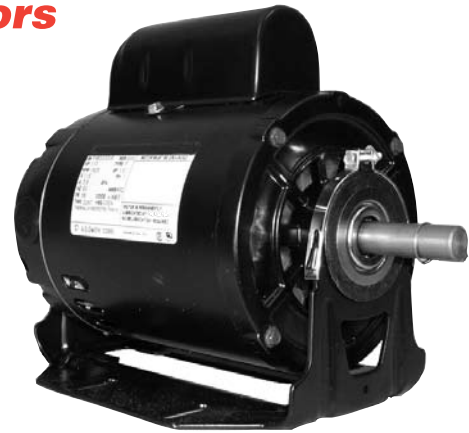

120/230 Volts

Part #	HP	Amps	Volts	RPM	Frame	Body	Shaft	Bearing	Comment
S1159	3/4	9.80	115/230	1/3450	56	1.00	1.9"x5/8"K	SLEEVE	1.25 S.F
R3958	3/4	10.40	115	1/1725	56	9.80	1.9"x5/8"K	SLEEVE	1.25 S.F
S1400	3/4	12.50	115/230	1/3450	56	8.60	1.9"x5/8"K	BALL	1.0 S.F
S1168	3/4	10.00	115/208-230	1/1725	56	7.50	1.9"x5/8"K	SLEEVE	1.0 S.F
S1174	3/4	13.00	115/208/230	1/1725	56	8.00	1.9"x5/8"K	BALL	HC46DX610,615,24-11960-000, 5002H,5002K,5033H,WW94X359, 1.25 S.F
S1169	3/4	7.80	115	1/1725	56	8.00	1.9"x5/8"K	SLEEVE	1.25 S.F
S3310	3/4	8.90	115	2/1725	56	9.50	1.9"x5/8"K	BALL	MARATHON B331, 1.25 S.F
S1166	3/4	13.65	115	1/1725	56	1.00	1.9"x5/8"K	SLEEVE	312P440, RS1074, 1.25 S.F
S1181	1	8.20	115/230	1/3450	56	1.00	1.9"x5/8"K	SLEEVE	1.15 S.F
S3340	1	11.50	115	2/1725	56	11.50	1.9"x5/8"K	BALL	1.25 S.F
S1199	1	12.80	115/208/230	1/1725	56	1.00	1.9"x5/8"K	BALL	1.15 S.F
S1187	1	13.60	115/230	1/1725	56	1.00	1.9"x5/8"K	BALL	1.0 S.F
S1186	1	14.20	115	1/1725	56	9.60	1.9"x5/8"K	SLEEVE	1.25 S.F
S1402	1	15.00	115/230	1/3450	56	9.10	1.9"x5/8"K	BALL	1.0 S.F
S1404	1-1/2	15.00	115/208	1/3450	56	7.60	1.9"x5/8"K	BALL	MARATHON B788, EMERSON 9034,FASCO D018, 110161, 327P649
S1336	1-1/2	16.40	115/208/230	1/1725	56	11.00	2.0"x5/8"K	BALL	A.O. SMITH 312P584
S1206	1-1/2	17.20	115/208/230	1/3450	56	11.60	1.9"x5/8"K	BALL	CARRIER HC45DL763, HC54DL751HC54DL763, R1261P134, 1.30 S.F
S1208	1-1/2	18.00	115/208/230	1/1750	56H	12.00	1.9"x5/8"K	BALL	FRANKLIN 12227, CENTURY C621 BALDOR RL1319A, R1261P133, 1.15 S.F
S1207	1-1/2	8.80	115/208/230	1/3450	56H	1.00	1.9"x5/8"K	SLEEVE	1.25 S.F
S1211	2	18.20	115/230	1/3450	56H	1.00	1.9"x5/8"K	SLEEVE	1.25 S.F
S1406	2	24.00	115/230	1/3450	56	10.10	1.9"x5/8"K	BALL	110232, B814, D012, 9035
S1216	2	24.60	115/208/230	1/1750	56H	15.30	1.9"x5/8"K	BALL	BOHN 5042H,R1271P133
S1408	3	15.00	208/230	1/3450	56	11.10	1.9"x5/8"K	BALL	1.0 S.F
S1410	5	22.00	208/230	1/3450	56HZ	11.20	2.3"x7/8"K	BALL	FASCO D017, B813, 120554

48 & 56 Frame Direct Drive Motors

Single Phase

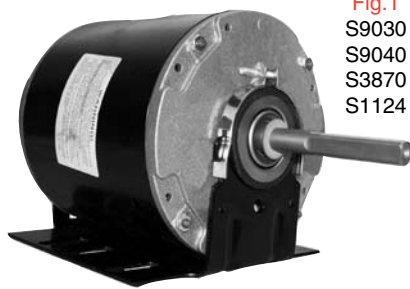

Fig.1
S9030
S9040
S3870
S1124



Fig.2
S1502
S1504
S1508
S9000
S1152



Fig.3
S1507A
S1506
S1506A

48/56 Frame Adapter



Part #	Description
92-A4856	Converts 48 to 56 frame motors

115/208/230/460 Volts - Ball Bearing

Part #	HP	Amps	Volts	RPM	Rot	Frame	Body	Shaft	Comment	Fig.
S9030	1/4	3.50	115	1/1725	REV.	48	7.60	2.9"x1/2"	MARATHON X903C/W 5/8"K ADAPTER	1
S9040	1/3	4.50	115	1/1725	REV.	48	7.50	2.9"x1/2"	MARATHON X904C/W 5/8"K ADAPTER	1
S3870	1/3	5.30	115	2/1725	REV.	56	7.80	1.9"x5/8"K	GE 5XBY02E (4397),PACKARD 17482, MARATHON B387, 1.35 S.F.	1
S1124	1/3	5.60	115/208/230	1/3450	REV.	48	8.60	1.6"x1/2"	CARRIER HC41KE651, HC41KL651R1221P114, 1.80S.F.	1
S1502	1/3	3.20	200/230/460	1/1075	REV.	48Y	7.30	3.5"x1/2"	24-18412-001,002, BOHN 5015HTRANE WW94X219, R3121P211, X445	2
S1106	1/3	6.60	115/208/230	1/3450	REV.	48	8.50	1.6"x1/2"	1.35S.F.	1
S1504	1/2	3.60	200/230/460	1/1075	REV.	48Y	12.20	3.6"x1/2"	REPLACES CARRIER, YORK,BLANCHARD, TRANE, R3131P211, X446	2
S1507A	1/2	4.60	208/230/460	1/1075	REV.	48	6.40	1.6"x1/2"	CARRIER F48SR6V2A1,R3131P310, OCA1056	3
S1506	1/2	1.40	575	1/1075	C.C.W.	48	5.00	4.0"x1/2"	MARATHON	3
S1508	1/2	1.60	575	1/1075	REV.	48Y	12.20	3.6"x1/2"	ADDISON, COMFORTAIRE,R3131P311, OSA1101815A, 4WD48A110180SA	2
S1506A	1/2	1.80	575	1/1075	C.C.W.	48	5.70	1.6"x1/2"	AO SMITH, CARRIER, 5OCA1056	3
S9000	1/2	6.60	115/230	1/1725	REV.	56Z	7.50	1.6"x1/2"K	AGRICULTURE FAN APPLICATIONS C/W 5/8" ADAPTER	2
S1152	1/2	7.20	115/208/230	1/3450	REV.	48	9.00	1.6"x1/2"	CARRIER HC43KE651, YORK 24-15447-003, R1231P114, 1.60 S.F.	2

Blower Motors



48 & 56 Frame Direct Drive Motors

Single Phase

Motors

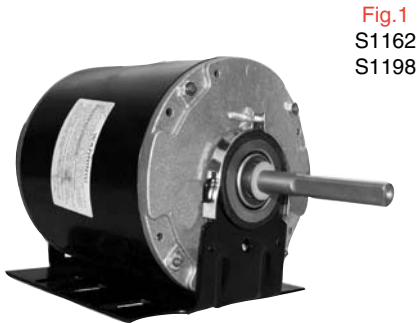

Fig.1
S1162
S1198



Fig.2
S1453
S1452
S1455
S1456
S1454



Fig.3
S1512
S1510
S1514
S1516
S1518
S1520

48/56 Frame Adapter



Part #	Description
92-A4856	Converts 48 to 56 frame motors

115/208/230/460 Volts - Ball Bearing

Part #	HP	Amps	Volts	RPM	Rot	Frame	Body	Shaft	Comment	Fig.
S1162	3/4	11.20	115/230	1/3480	REV.	56	9.10	1.9"x5/8"K	RL1306A, 4509/M2614, 10063/K155, 73073, 1.25 S.F.	1
S1452	3/4	3.90	208/230/460	1/1075	REV.	56	8.10	6.1"x5/8"K	CLIMATROL, EMERSON K3566, X207, U.E. C512, C513, C661	2
S1512	3/4	4.60	200/230/460	1/1075	REV.	48Y	10.80	3.5"x5/8"	KEEPRITE 106087, 106563, 170619	3
S1510	3/4	5.40	200/230/460	1/1075	REV.	48Y	12.20	3.6"x1/2"	CARRIER, YORK, BOHN, LENNOX & DUNHAM BUSH	3
S1514	1	6.40	200/230/460	1/1075	REV.	48/56	11.50	4.0"x5/8"	CARRIER HC51TE200, HC51TE230HC51TE460	3
S1453	1	6.50	200/230/460	1/1075	C.C.W.	56Y	10.20	3.5"x5/8"K	CARRIER HC51TE200, 230, 460	2
S1198	1	12.60	115/208/230	1/3450	REV.	56	10.00	1.9"x5/8"K	TRANE WW94X241, WW94X384, CARRIER HC52DL756, 1.40 S.F.	1
S1455	1	2.10	575	1/1075	REV.	56	9.80	3.6"x5/8"K	CARRIER	2
S1516	1	2.20	575	1/1075	REV.	58Y	11.50	4.0"x5/8"	CARRIER HC51TE575	3
S1518	1-1/2	7.00	200/230/460	1/1075	REV.	48/56	12.00	4.0"x5/8"	CARRIER HC52TE231	3
S1520	1-1/2	3.20	575	1/1075	REV.	48/56	12.00	4.0"x5/8"	F48SZ6V2, 5FC1165	3
S1456	1-1/2	7.70	208/230/460	1/1075	REV.	56	10.50	6.1"x5/8"	TRANE, CARRIER, CLIMATROL, YORK, C771, X208, X271	2
S1454	1-3/4	5.50	208/230/460	1/1075	REV.	56	10.50	6.1"x5/8"K	REPLACEMENT FOR CARRIER, TRANE, YORK, CLIMATROL	2

56 Frame Belted Fan Motors

Three Phase



Motors

208/230/460/575 Volt - Ball Bearing

Part #	HP	Amps	Volts	RPM	Rotation	Body	Shaft	Comment
T2102	1/3	8.50	208/230/460	1/1725	REV.	8.50	1.9"x5/8"K	1.35 S.F.
T2110	1/2	1.80	230/460	1/3450	REV.	9.00	2.0"x5/8"	YORK 24-15447-004,R1433A424, 1.60 S.F
T2104	1/2	1.90	230/460	1/1750	REV.	9.50	2.0"x5/8"	HD43KE440, TRANE WW94X282,ADDISON 8101-376, R1433P423, 1.25 S.F.
T2118	3/4	2.60	208/230/460	1/1725	REV.	9.10	1.9"x5/8"K	BALDOR M3112A, FASCO D5626, MARATHON G101, CENTURY H851 1.25 S.F.
T2114	3/4	3.20	208/230/460	1/3450	REV.	8.60	1.9"x5/8"K	HD46DL575,P2617701311P457,858-312P157,204,231, 1.25 S.F.
T2121	3/4	0.90	575	1/1725	REV.	8.80	1.9"x5/8"	MARATHON G962, 1.25 S.F.
T2123	3/4	1.05	575	1/3450	REV.	9.50	2.0"x5/8"	YORK 24-15447-002,006,24-13776-008, R1443A324, 1.50 S.F.
T2126	1	5.00	208/230/460	1/3450	REV.	9.60	1.9"x5/8"K	BALDOR M3115A, CENTURY H842,MARATHON G180 1.15 S.F.
T2130	1	3.60	208/230/460	1/1725	REV.	9.60	1.9"x5/8"K	MARATHON G100 1.15 S.F.
T2133	1	1.50	575	1/3450	REV.	8.50	2.0"x5/8"	CARRIER HD52DE208, LENNOX P-8-2162, R1453P324, 1.25 S.F.
T2135	1	1.50	575	1/1750	REV.	8.80	2.0"x5/8"	YORK 24-13763-000, BLANCHARD E3016, R1453P323, 1.15 S.F.
T2142	1-1/2	4.10	208/230/460	1/3450	REV.	11.60	2.0"x5/8"	HC54AE652, HC54DL651, 653P261-7501, R1463A244 1.30 S.F.
T2136	1-1/2	4.30	208/230/460	1/3450	REV.	10.10	1.9"x5/8"K	BALDOR RM3120A, CENTURY H843 MARATHON G126, G183, 1.15 S.F.
T2138	1-1/2	4.40	208/230/460	1/1750	REV.	12.30	2.0"x5/8"	TRANE WW94X214, BOHN 5009H24-17671-002,006, R1463P233, 1.15 S.F.
T2140	1-1/2	4.60	208/230/460	1/1725	REV.	9.60	1.9"x5/8"K	BALDOR RM3154A, FASCO D5630,MARATHON G126, CENTURY H853, 1.15 S.F.
T2154	2	5.80	208/230/460	1/1725	REV.	10.60	1.9"x5/8"K	MARATHON G128, 1.15 S.F.
T2156	2	6.00	208/230/460	1/3450	REV.	11.60	1.9"x5/8"K	CARRIER HD56AE700,HD56DZ851, YORK 24-17671-003, R1473A244, 1.15 S.F.
T2157	2	2.15	575	1/3450	REV.	11.60	2.3"x3/4"	YORK 24-10521-000,R1473P344, 1.20 S.F.
T2164	3	8.90	208/230/460	1/3450	REV.	9.50	2.3"x7/8"	CARRIER HD58AE700,YORK 24-10341-000, R1483P244, 1.15 S.F.
T2167	3	3.60	575	1/1725	REV.	1.00	1.9"x5/8"	GEN. REPLACEMENT, 1.15 S.F.
T2170	5	5.00	575	1/3450	REV.	12.60	2.3"x7/8"	A.O. SMITH 5BK3502,P56R2T11B2, R1493A344, 1.15 S.F.

Blower Motors



56 Frame Direct Drive Motors

Three Phase

Fig.1
T2530
T2531
T2535



Fig.2
T2532 T2538
T2534 T2540
T2533 T2542
T2537 T2544
T2539 T2536

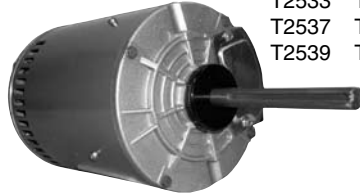

Fig.3
T1532
T1534
T1536
T1540
T1542
T2543



Fig.4
T1826
T1946



208/230/460/575 Volt - Ball Bearing

Part #	HP	Amps	Volts	RPM	Rotation	Body	Shaft	Comment	Fig.
T2530	1/3	2.20	208/230/460	1/1140	REV.	8.50	1.2"x1/2"	LIEBERT	1
T2532	1/2	2.40	208/230/460	3/1140	REV.	1.00	5.0"x5/8"	CLIMATE MASTER, DUNHAM BUSH W/ VOLTAGE CHANGE DEVICE	2
T1532	1/2	3.00	200/230/460	1/1140	REV.	9.20	3.5"x1/2"	CARRIER HD44ML460,HD44SX651, R3433A212	3
T2533	1/2	1.00	575	3/1140	REV.	1.00	5.0"x5/8"	W/ VOLTAGE CHANGE DEVICE	2
T2534	3/4	3.20	208/230/460	1/1140	REV.	8.60	5.0"x5/8"K	UE H567, HD45SX660, FC3076,WWG 3M496, 1817, GE K378	2
T1534	3/4	4.00	200/230/460	1/1140	REV.	11.00	4.0"x5/8"	HD44SX660, HD46SX660,VL330,HD46VL331, 24-16498-000	3
T2531	3/4	4.00	208/230/460	1/1100	REV.	8.00	3.0"x5/8"	MARATHON K456	1
T2535	3/4	1.40	575	1/1140	REV.	8.10	3.0"x5/8"	LIEBERT 1C16992P1,CMS LCFM575	1
T1536	3/4	1.50	575	1/1140	REV.	11.00	4.0"x5/8"	KEEPRITE 106670,R3443A312	3
T2538	1	4.00	208/230/460	3/1140	REV.	1.00	5.0"x5/8"	KEEPRITE, YORK, TRANE,CARRIER, LENNOX	2
T2537	1	5.30	208/230/460	1/850	REV.	11.10	5.0"x5/8"	BLANCHARD NESS, HUSSMANN W/ VOLTAGE CHANGE DEVICE	2
T1538	1	5.60	200/230/460	1/1140	REV.	11.50	4.0"x5/8"	KEEPRITE 170518, 105062,106669, 502595, R3453A212	2
T2540	1	1.70	575	1/1140	REV.	9.10	5.0"x5/8"	KEEPRITE, YORK, TRANE,CARRIER, LENNOX	2
T2539	1	2.10	575	1/850	REV.	11.10	5.0"x5/8"	BLANCHARD NESS, HUSSMANN, W/ VOLTAGE CHANGE DEVICE	2
T1540	1	2.30	575	1/1140	REV.	11.50	4.0"x5/8"	KEEPRITE 170517, 105063,R3453A312	3
T1826	1-1/4	5.00	208/230	1/1100	REV.	9.50	3.0"x5/8"	KEEPRITE 1043397-001 (VERTICAL MOUNT)	4
T1946	1-1/4	2.00	575	1/1100	REV.	9.50	3.0"x5/8"	KEEPRITE REFRIGERATION 1043299-001	4
T2542	1-1/2	5.50	208/230/460	1/1140	REV.	10.10	5.0"x5/8"	CARRIER HD54SX680, WWG 3N470AO SMITH FC3156	2
T1542	1-1/2	5.80	200/230/460	1/1140	REV.	11.50	4.0"x5/8"	CARRIER HD54SX680, R1463A222 KEEPRITE 107002, 107108,	3
T2543	1-1/2	2.20	575	1/1140	REV.	9.50	5.0"x5/8"K	KEEPRITE, YORK, CARRIER,LENNOX, TRANE MOT1590	3
T2544	2	7.20	208/230/460	1/1140	REV.	11.10	5.0"x5/8"	CANCOIL W/ VOLTAGE CHANGE DEVICE	2
T2536	2	2.70	575	1/1140	C.W.	11.10	5.0"x5/8"	CANCOIL W/ VOLTAGE CHANGE DEVICE	2

4.8" & 5.7" Diameter - "Lamb - Ametek" Vacuum Motors

Typical Applications : Canister Type Vacuums, Utility Vacuums, Light Duty Commercial, Dry Applications Only

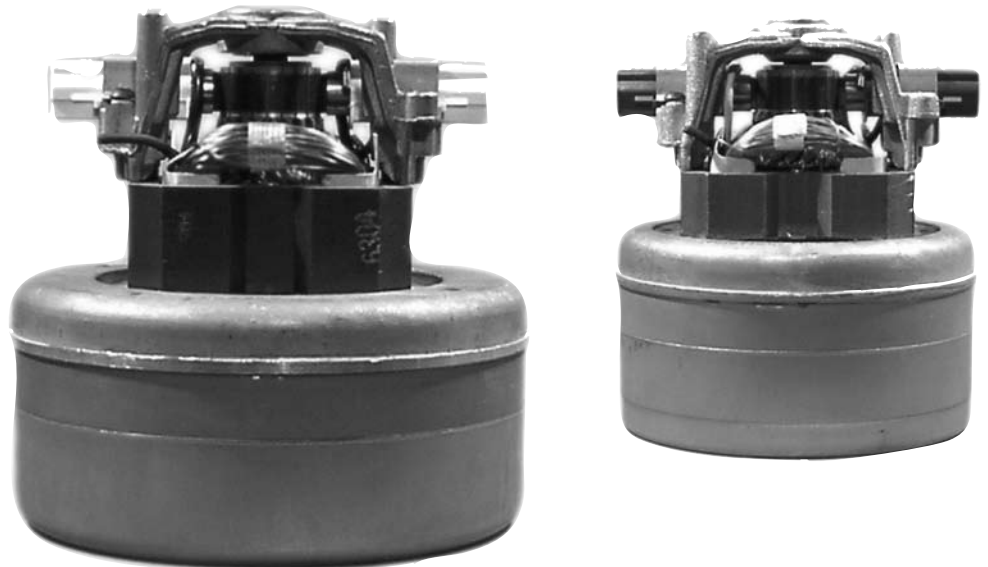

Motors

4.3" Diameter Two Stage

Part #	Volts	Amps	Bearings	Discharge	Comments
116378-00	115	7.5	Ball/Ball	Thru-Flow	Standard Design

4.8" Diameter Two Stage

Part #	Volts	Amps	Bearings	Discharge	Comments
116148-00	115	6.3	Ball/Sleeve	Thru-Flow	Standard Design

5.7" Diameter Single Stage

Part #	Volts	Amps	Bearings	Discharge	Comments
116309-00	115	6.8	Ball /Sleeve	Thru-Flow	Standard Design, Replaces 115717
116455-50	115	6.8	Ball /Sleeve	Thru-Flow	Standard Design
116297-00	115	6.9	Ball /Sleeve	Thru-Flow	High Efficiency Design, Replaces 115924
117760-00	115	7.0	Ball/Ball	Thru-Flow	Standard Design
119400-00	115	7.0	Ball/Ball	Thru-Flow	Standard Design
115955	220/240	3.2	Ball /Sleeve	Thru-Flow	Standard Design
116310-00	220/240	3.8	Ball /Sleeve	Thru-Flow	Standard Design

5.7" Diameter Two Stage

Part #	Volts	Amps	Bearings	Discharge	Comments
115756	220	3.82	Ball/Sleeve	Thru-Flow	Standard Design
115792	115	4.0	Ball/Sleeve	Thru-Flow	Specially Wound for Reduced Performance
116670-50	230	4.6	Ball/Sleeve	Thru-Flow	Standard Design
116311-00	115	7.7	Ball/Sleeve	Thru-Flow	Standard Design, Replaces 115737
116311-01	115	7.7	Ball/Ball	Thru-Flow	Standard Design, Replaces 115750
115744	115	8.0	Ball/Sleeve	Thru-Flow	Automatic Thermal Overload, Standard Design
116457-00	115	8.3	Ball/Ball	Thru-Flow	Standard Design
116669-50	115	8.6	Ball/Ball	Thru-Flow	Standard Design
116227-00	115	8.8	Ball/Ball	Thru-Flow	Two Speed, Replaces 115736, Standard Design
116671-50	115	9.4	Ball/Sleeve	Thru-Flow	Standard Design
115982	115	9.5	Ball/Sleeve	Thru-Flow	High Efficiency Design
116429-00	115	9.6	Ball/Sleeve	Thru-Flow	High Efficiency Design, Automatic Thermal Overload
115923	115	9.7	Ball/Ball	Thru-Flow	High Efficiency Design
116432-00	115	10.6	Ball/Ball	Thru-Flow	Standard Design
116312-00	220	4.0	Ball/Sleeve	Thru-Flow	Standard Design, Replaces 115756
116343-00	230	4.7	Ball/Sleeve	Thru-Flow	High Efficiency Design

Rotation determined opposite shaft end
Double shaft determined at lead end

Shaft length measured from hub
face to shaft end

By-Pass Vacuum Motors



5.7" Diameter - "Lamb - Ametek" Vacuum Motors

Typical Applications : Utility Vacuums, Commercial Vacuums, Carwash Vacuums, Steam Carpet Cleaners

Peripheral Discharge



Tangential Discharge



Single Stage

Part #	Volts	Amps	Bearings	Discharge	Comments
116325-00	115	5.6	Ball/Sleeve	Peripheral	Standard Design
116520-50	115	5.8	Ball/Sleeve	Tangential	Standard Design
116299-00	120	5.8	Ball/Sleeve	Peripheral	Standard Design
116196-00	115	7.0	Ball/Sleeve	Peripheral	"High Airflow" Design
115977	230	3.8	Ball/Sleeve	Peripheral	"High Airflow" Design
116340-00	230	3.8	Ball/Sleeve	Peripheral	"High Airflow" Design

Two Stage

Part #	Volts	Amps	Bearings	Discharge	Comments
116155-00	24 VDC	14.4	Ball/Ball	Peripheral	Air Sealed Bearing Protection, Epoxy Coated Fan Case
116157-00	24 VDC	14.4	Ball/Ball	Tangential	Air Sealed Bearing Protection, Epoxy Coated Fan Case
115460	24 VDC	14.8	Ball/Ball	Peripheral	Standard Design
116156-00	36 VDC	10.8	Ball/Ball	Peripheral	Air Sealed Bearing Protection, Epoxy Coated Fan Case
116158-00	36 VDC	10.8	Ball/Ball	Tangential	Air Sealed Bearing Protection, Epoxy Coated Fan Case
116409-13	36 VDC	13.0	Ball/Ball	Tangential	Standard Design
116158-01	36 VDC	17.5	Ball/Ball	Tangential	Standard Design
116406-13	115	15.1	Ball/Ball	Peripheral	Air Sealed Bearing Protection, Epoxy Coated Fan Case
116757-13	115	7.9	Ball/Ball	Peripheral	Low Noise "Acustek" Design, Epoxy Coated Fan Case, Air Sealed Bearing
116336-00	115	8.0	Ball/Sleeve	Peripheral	Standard Design, Replaces 115757
116336-01	115	8.0	Ball/Ball	Peripheral	Standard Design
116392-00	115	8.0	Ball/Ball	Tangential	Air Sealed Bearing Protection, Epoxy Coated Fan Case, Replaces 115894
116392-01	115	8.6	Ball/Ball	Tangential	Standard Design
116212-00	115	9.1	Ball/Ball	Peripheral	Epoxy Coated Fan Case
116114-00	115	9.1	Ball/Ball	Tangential	Air Sealed Bearing Protection, Epoxy Coated Fan Case
116207-00	115	9.1	Ball/Ball	Tangential	Epoxy Coated Fan Case
115909	115	9.1	Ball/Ball	Tangential	Air Sealed Bearing Protection, Epoxy Coated Fan Case
116758-13	115	9.1	Ball/Ball	Peripheral	Low Noise "Acustek" Design, Epoxy Coated Fan Case, Air Sealed Bearing
119407-13	115	10.7	Ball/Ball	Tangential	Standard Design
116763-13	115	11.3	Ball/Ball	Peripheral	Low Noise "Acoustek" Design
116471-00	115	11.7	Ball/Ball	Peripheral	Standard Design
116472-13	115	11.7	Ball/Ball	Tangential	Standard Design
116472-00	115	11.7	Ball/Ball	Tangential	Standard Design
117100-00	115	12.0	Ball/Ball	Tangential	Standard Design
119631-00	115	14.5	Ball/Ball	Tangential	Air watts Series
116125-00	230	3.3	Ball/Sleeve	Peripheral	Standard Design
119405-00	230	3.4	Ball/Ball	Peripheral	Standard Design
116213-00	230	4.6	Ball/Ball	Tangential	Epoxy Coated Fan Case
116420-13	230	4.4	Ball/Ball	Tangential	Air Sealed Bearing Protection, Epoxy Coated Fan Case
116549-13	230	5.9	Ball/Ball	Peripheral	Low Noise "Acoustek" Design

Motors

5.7" & 7.2" Diameter - "Lamb - Ametek" Vacuum Motors

Typical Applications : Utility Vacuums, Commercial Vacuums, Carwash Vacuums, Steam Carpet Cleaners

Peripheral Discharge



Tangential Discharge



5.7" Three Stage

Part #	Volts	Amps	Bearings	Discharge	Comments
116514-13	24VDC	21.0	Ball/Ball	Peripheral	Standard Design
116515-13	24VDC	21.0	Ball/Ball	Tangential	Standard Design
116598-13	24VDC	22.7	Ball/Ball	Peripheral	"Acoustek" Design
116512-13	36VDC	17.4	Ball/Ball	Peripheral	Standard Design
116513-13	36VDC	17.4	Ball/Ball	Tangential	Standard Design
119432-13	36VDC	17.4	Ball/Ball	Tangential	Standard Design
116565-00	115	10.3	Ball/Ball	Tangential	Standard Design
116565-13	115	10.3	Ball/Ball	Tangential	Standard Design
116566-13	115	10.3	Ball/Ball	Peripheral	Standard Design
116764-13	115	10.7	Ball/Ball	Peripheral	"Acoustek" Design
116765-00	115	10.7	Ball/Ball	Tangential	Standard Design
116765-13	115	10.7	Ball/Ball	Tangential	Standard Design
116859-13	230	6.8	Ball/Ball	Tangential	Standard Design
117123-00	230	6.8	Ball/Ball	Tangential	Standard Design

7.2" Two Stage

Part #	Volts	Amps	Bearings	Discharge	Comments
117465-13	120	11.3	Ball/Ball	Tangential	Redesign
117508-13	120	11.4	Ball/Ball	Peripheral	Redesign
117467-00	120	12.2	Ball/Ball	Tangential	Redesign
115991	120	13	Ball/Ball	Tangential	Old Style
115962	115	13.0	Ball/Ball	Peripheral	Air Sealed Bearing Protection, Epoxy Coated Fan Case
117465-00	115	13.3	Ball/Ball	Tangential	Standard Design, Replaces 115334, 116465-00
115330	115	13.5	Ball/Ball	Peripheral	Standard Design
115334	115	13.5	Ball/Ball	Tangential	Standard Design
115937	115	13.5	Ball/Ball	Tangential	Air Sealed Bearing Protection, Epoxy Coated Fan Case, Replaces 115837
117467-00	115	14.5	Ball/Ball	Tangential	"High Performance" Design, Replaces 116467-00
117549-12	120	15.3	B/B	Tangential	Premier Design
115963	220	5.5	Ball/Ball	Peripheral	Air Sealed Bearing Protection, Epoxy Coated Fan Case
115684	220/240	5.5	Ball/Ball	Tangential	Epoxy Coated Fan Case
115950	220/240	5.5	Ball/Ball	Tangential	Air Sealed Bearing Protection, Epoxy Coated Fan Case
115519	220/240	6.0	Ball/Ball	Peripheral	Epoxy Coated Fan Case

Rotation determined opposite shaft end
Double shaft determined at lead end

Shaft length measured from hub
face to shaft end

Thru-Flow Vacuum Motors



7.2" & 7.5" Diameter - "Lamb - Ametek" Vacuum Motors

Typical Applications : Central Vacuums, Carwash Vacuums, Commercial/Industrial Vacuum systems, Steam Carpet Cleaners

Peripheral Discharge
7.2" Motor



Tangential Discharge



Peripheral Discharge
7.5" Motor



Brushless



7.2" Three Stage

Part #	Volts	Amps	Bearings	Discharge	Comments
116119-00	115	12.6	Ball/Ball	Tangential	Standard Design
117511-00	115	12.7	Ball/Ball	Peripheral	Redesign
116118-00	115	12.8	Ball/Ball	Peripheral	Air Sealed Bearing Protection, Epoxy Coated Fan Case
117507-00	115	13.0	Ball/Ball	Tangential	"Long Life" Design, Replaces 116507-00
116137	115	13.0	Ball/Ball	Peripheral	Old Style
117507-13	115	13.8	Ball/Ball	Tangential	"Long Life" Design, Air Sealed Bearing Protection, Epoxy Coated Fan Case, Replaces 116507-13
116103-00	115	13.8	Ball/Ball	Tangential	Air Sealed Bearing Protection, Epoxy Coated Fan Case
117500-12	115	15.5	Ball/Ball	Tangential	Premier Design
116139	220	6.7	Ball/Ball	Peripheral	Old Style
116136-00	220	6.8	Ball/Ball	Tangential	Old Style
116154-00	220	6.8	Ball/Ball	Tangential	Old Style

7.5" Two Stage

Part #	Volts	Amps	Bearings	Discharge	Comments
114786	115	10.4	Ball/Ball	Peripheral	Heavy Duty Construction
114788	220	5.0	Ball/Ball	Peripheral	Heavy Duty Construction

7.5" Three Stage

Part #	Volts	Amps	Bearings	Discharge	Comments
114787	120	11.0	Ball/Ball	Peripheral	Heavy Duty Construction
114789	220	5.3	Ball/Ball	Peripheral	Heavy Duty Construction

Brushless "Infin-A-Tek" By-Pass Vacuum Motors

5.7" Tangential - Two Stage

Part #	Volts	Amps	Bearings	Discharge	Comments
121101-13	115	9.0	Ball/Ball	Tangential	Brushless, High Efficiency
121102-13	230	4.7	Ball/Ball	Tangential	Brushless, High Efficiency

7.2" Tangential - Two Stage

Part #	Volts	Amps	Bearings	Discharge	Comments
121113-01	115	10.0	Ball/Ball	Tangential	Brushless, High Efficiency
121114-01	230	5.3	Ball/Ball	Tangential	Brushless, High Efficiency

Pellet Stove Gear Auger Motors

Gear Motors

- 115 Volt
- Single Speed
- CCW Rotation
- Sleeve Bearing
- Shaded Pole

Avalon, Austroflamm, Breckwell, Enviro, Earth Stove, Fasco, Lennox, Merkle-Korff Ind., tional Steel Crafters, Pellet Master, Travis Ind., Whitfield (Quest), Traditions & Profile Series Stoves...



Fig. 1

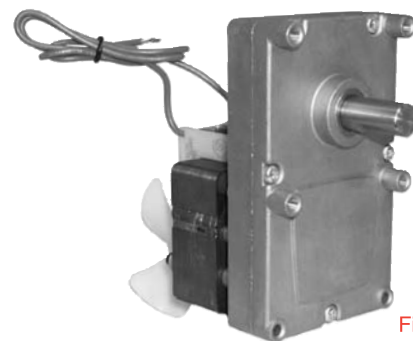

Fig. 2

Part #	RPM	Speed	Amps	Volts	Rot	Shaft	Body	Type	Mounting	Cross	Fig
RGM451	1.0	ONE	0.43	115	C.C.W.	1.1x3/8	3.00	S.P.	6 PT.	WHITFIELD 4514U1-063	1
RGM452	2.0	ONE	1.26	115	C.C.W.	1.1x3/8	3.10	S.P.	6 PT.	CDN. COMFORT IND. V07926AAD9 V002, 170"-LBS TRQ LOAD F/L	1
RGM651	5.5	ONE	1.00	115	C.C.W.	1.1x1/2"	3.25	S.P.	6 PT.	WHITFIELD, ECM6216	2

Pellet Stove Blower Motors

Whitfield - Quest

Whitfield - Quest 12026011, 13656011, Breckwell, Travis (Avalon & Lopi) Quadra-Fire, Fasco 7021-9129

Part #	HP	Volts	Amps	Type	RPM	Rot	Body	Frame	Bearing
RBM120	1/14	115	0.6	SP/Open	1/3000	CCW	5.25"	3.3"	Sleeve



Whitfield - Convection Blower

Whitfield 12126109, Fasco 7021-7786

Part #	HP	Volts	Amps	Type	RPM	Rot	Body	Frame	Bearing
RBM121	1/35	115	1.5	SP/Open	1/3000	CW	7.3"	3.3"	Sleeve



Lennox - Earth Pellet Stove Blower

Lennox 15007 (Model), 8253710702 (Blower)

Part #	HP	Volts	Amps	Type	RPM	Rotation	Body	Frame	Bearing
RB150	1/8	115	1.0	SP/Open	1/1500	CW	7.4"	3.3"	Sleeve



Rotation determined opposite shaft end
Double shaft determined at lead end

Shaft length measured from hub
face to shaft end

Tangential Blowers



CW Rotation

RB66 RB64
RB69 RB82 *illustrated*

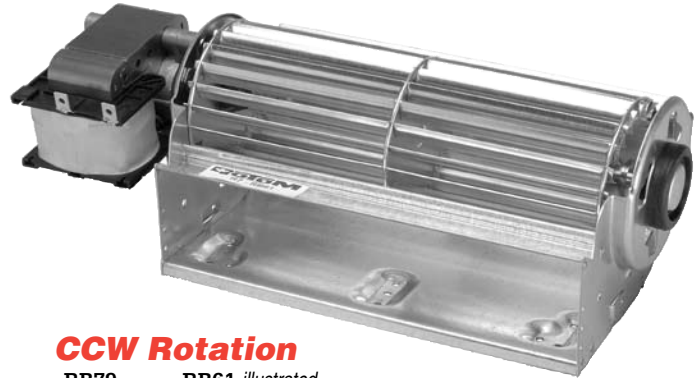

CCW Rotation

RB79 RB61 *illustrated*
RB84 RB86

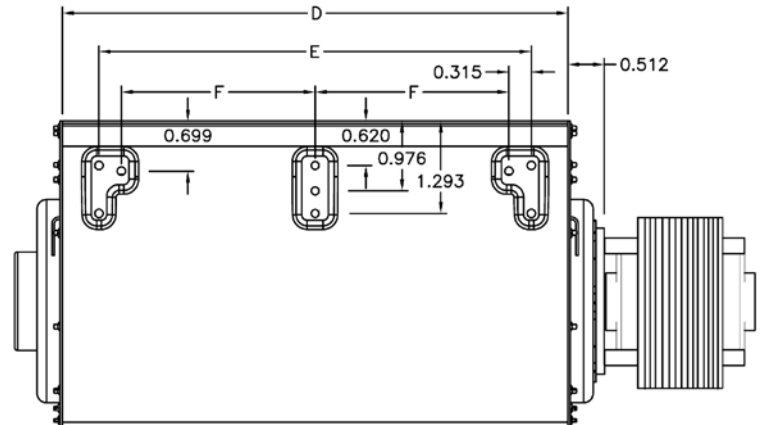
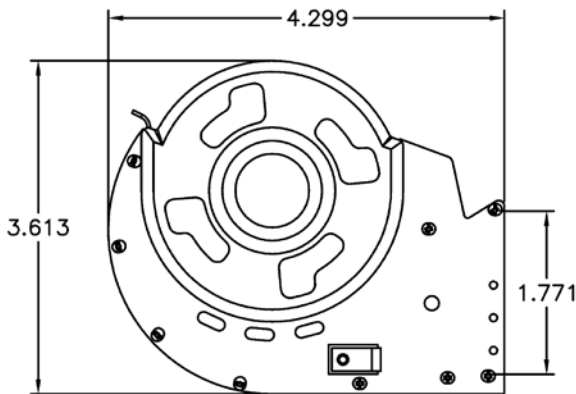
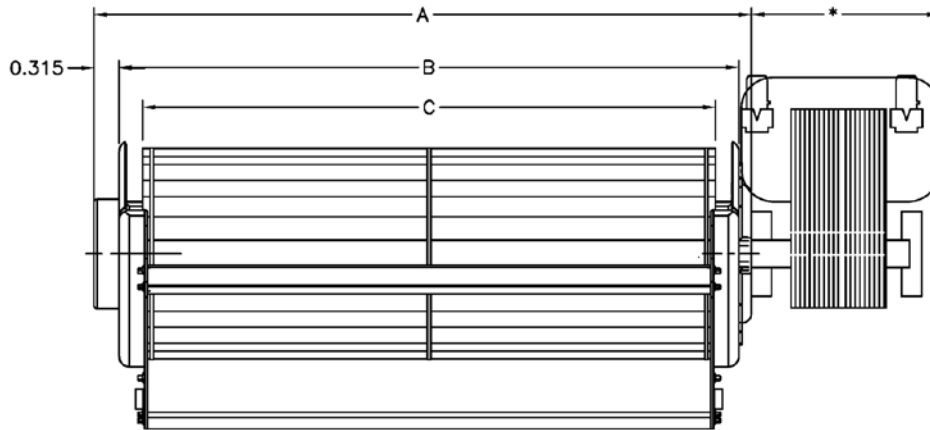

65mm Tangential Fans

Part #		Watts	Amps	RPM	CFM	Bear.	Body	Wheel	Dimensions					
CW	CCW								A	B	C	D	E	F
RB66	RB86	35	0.75	1/1800	80	Sleeve	8.0"×4.3"×3.6"	65×120mm (2.6×4.7")	5.91"	5.44"	4.90"	4.72"	3.70"	1.54"
RB82	RB61	42	0.75	1/1400	110	Sleeve	10.5"×4.3"×3.6"	65×180mm (2.6×7.1")	8.27"	7.80"	7.21"	7.09"	6.06"	2.72"
RB64	RB84	50	0.86	1/1200	130	Sleeve	12.9"×4.3"×3.6"	65×240mm (2.6×9.4")	10.27"	10.16"	9.56"	9.45"	8.43"	3.90"
RB69	RB79	62	1.10	1/1200	150	Sleeve	15.7"×4.3"×3.6"	65×300mm (2.6×11.8")	12.94"	12.46"	11.87"	11.81"	10.79"	5.08"

Tangential Blowers

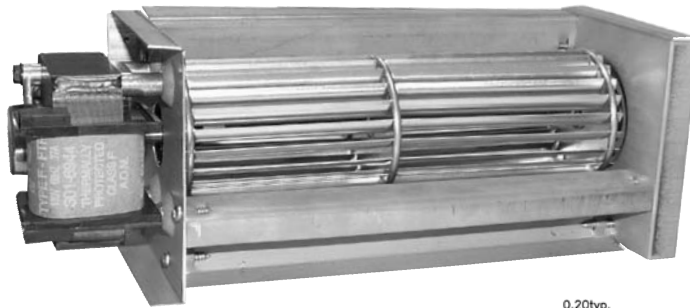

RB944
illustrated

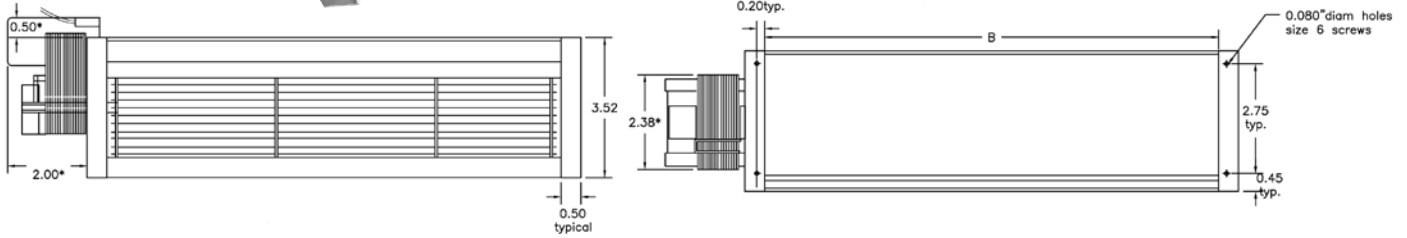
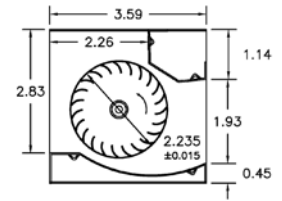

65mm Box Frame Fans

Part #	Watts	Volts	Amps	RPM	Rotation	CFM	Bearing	Body	Wheel	B
RB944	17	115	0.77	1/2900	CCW	105	Sleeve	10.3"×3.6"×3.6"	2.25"×7.13"	7.31"
RB939	29	115	0.62	1/2800	CW	180	Ball	15.5"×3.6"×3.6"	2.25"×12.25"	12.46"
RB949	29	115	0.97	1/2900	CCW	180	Ball	15.5"×3.6"×3.6"	2.25"×12.25"	12.46"
RB950	29	240	0.30	1/2900	CCW	180	Sleeve	15.5"×3.6"×3.6"	2.25"×12.25"	12.46"
RB948	34	115	0.77	1/2900	CCW	210	Sleeve	17.3"×3.6"×3.6"	2.25"×14.00"	14.25"



RB96
illustrated



RB221
illustrated

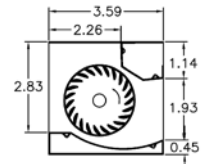
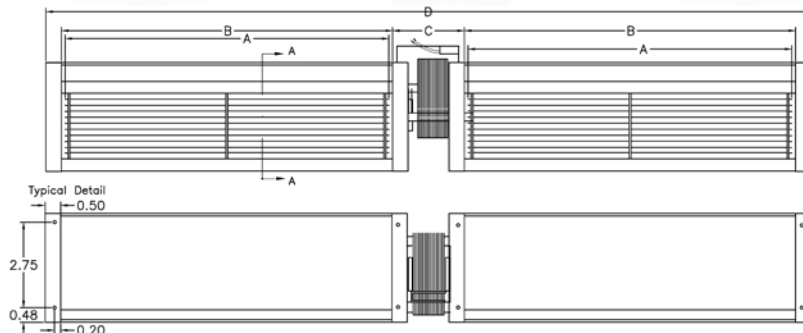

Double Tangential Fans

Sil-Flo: Marcot Baseboard Heater, Lau T221-18 (HB-RB221)

Part #	Watts	Volts	Amps	RPM	Rotation	CFM	Bearing	Body	Frame	Wheel	B	C	D
RB96	58	115	1.50	1/2900	CW	360	Sleeve	28.6"×3.6"×3.6"	Skel.	2.25"×12.25"	12.46"	3.02"	28.61"
RB221	12	115	0.60	2/1550	CCW	180/370	Sleeve	41"×3.6"×3.6"	3.3"	2.25"×17.25"	18.19"	3.19"	40.57"

Rotation determined opposite shaft end
Double shaft determined at lead end

Shaft length measured from hub face to shaft end

DC Axial Fans

40mm x 40mm x 20mm (1.57" x 1.57" x 0.79")

- Mounting Centres 32mm (1.26")

Part #	Volts	CFM	Bearing	Impeller	Noise	Connection	Weight
RF265	12VDC	7	Sleeve	Plastic	26dB (A)	Wire Leads	40g
RF268	12VDC	8.5	Sleeve	Plastic	31dB (A)	Wire Leads	40g

60mm x 60mm x 25mm (2.36" x 2.36" x 1.00")

- Mounting Centres 50mm (1.97")

Part #	Volts	CFM	Bearing	Impeller	Noise	Connection	Weight
RF270	12VDC	16.7	Sleeve	Plastic	25dB(A)	Wire Leads	75g

80mm x 80mm x 25mm (3.15" x 3.15" x 1.00")

- Mounting Centres 71.5mm (2.82")

Part #	Volts	CFM	Bearing	Impeller	Noise	Connection	Weight
RF275	12VDC	30	Sleeve	Plastic	24dB(A)	Wire Leads	85g
RF280	12VDC	37	Sleeve	Plastic	30dB(A)	Wire Leads	85g

92mm x 92mm x 25mm (3.62" x 3.62" x 1.00")

- Mounting Centres 82mm (3.25")

Part #	Volts	CFM	Bearing	Impeller	Noise	Connection	Weight
RF285	12VDC	50.5	Sleeve	Plastic	30dB(A)	Wire Leads	120g
RF287	12VDC	41.5	Sleeve	Plastic	28dB(A)	Wire Leads	120g

120mm x 120mm x 25mm (4.70" x 4.70" x 1.00")

- Mounting Centres 104.8mm (4.13")

Part #	Volts	CFM	Bearing	Impeller	Noise	Connection	Weight
RF290	12VDC	74.5	Sleeve	Plastic	44dB(A)	Wire Leads	150g
RF292	12VDC	61.4	Sleeve	Plastic	38dB(A)	Wire Leads	150g



Rotom Room-to-Room Air Booster

The RDF150 is a simple, inexpensive, easy to install and remarkably silent solution to uncomfortable and frustrating room to room heating or cooling problems. Mounted in a doorway and featuring a rotating bracket, it is possible to position or direct the enhanced airflow from one remote area to another for maximum, even heat distribution.

- Kit includes:
- Point of Purchase box with sleeve
 - 12' Cord with inline switch
 - Metal impeller
 - Die-cast aluminium housing
 - Chrome fan guards
 - Mounting swivel bracket & hardware



RDF150

Shaft length measured from hub face to shaft end

Rotation determined opposite shaft end
Double shaft determined at lead end

AC Axial Fans

80mm x 80mm x 38mm (3.15" x 3.15" x 1.5")

- Mounting Centres 71.5mm (2.82")

Part #	Watts	Volts	CFM	RPM	Bearing	Impeller	Noise	Connection	Weight
RF200	10	115	32	3100	Sleeve	Metal	34db (A)	Wire Leads	420g
RF201	9	115	21	2000	Sleeve	Metal	26db (A)	Wire Leads	420g
RF202	10	230	32	3100	Ball	Metal	34db (A)	Wire Leads	420g

120mm x 120mm x 38mm (4.72" x 4.72" x 1.5")

- Mounting Centres 105mm (4.13")

Part #	Watts	Volts	CFM	RPM	Bearing	Impeller	Noise	Connection	Weight
RF205	22	115	106	3000	Sleeve	Metal	50db (A)	Terminal	600g
RF210	22	115	106	3000	Ball	Metal	50db (A)	Terminal	600g
RF225	22	115	106	3000	Ball	Metal	50db (A)	Wire Leads	600g
RF215	21	230	106	3000	Sleeve	Metal	50db (A)	Terminal	600g
RF220	21	230	106	3000	Ball	Metal	50db (A)	Terminal	600g

119mm x 119mm x 38mm (4.69" x 4.69" x 1.5")

- Mounting Centres 105mm (4.13")

Part #	Watts	Volts	CFM	RPM	Bearing	Impeller	Noise	Connection	Weight
RF230	12	115	106	3100	Sleeve	Plastic	46db (A)	Terminal	530g
RF235	12	115	106	3100	Ball	Plastic	46db (A)	Terminal	530g
RF236	15	230	106	3100	Sleeve	Plastic	46db (A)	Terminal	530g
RF237	15	230	106	3100	Ball	Plastic	46db (A)	Terminal	530g

150mm x 150mm x 55mm (5.9" x 5.9" x 2.2")

- Mounting Centres 162mm (6.38")

Part #	Watts	Volts	CFM	RPM	Bearing	Impeller	Noise	Connection	Weight
RF240	42	115	230	3400	Ball	Plastic	53db (A)	Wire Leads	1kg
RF245	40	230	230	3400	Ball	Plastic	53db (A)	Wire Leads	1kg

150mm x 172mm x 38mm (5.9" x 6.7" x 1.5")

- Mounting Centres 162mm (6.38")

Part #	Watts	Volts	CFM	RPM	Bearing	Impeller	Noise	Connection	Weight
RF247	28	115	212	3400	Ball	Plastic	58db (A)	Terminal	720g
RF248	26	230	212	3400	Ball	Plastic	58db (A)	Terminal	720g

180mm x 180mm x 90mm (7.1" x 7.1" x 3.5")

- Mounting Centres 152.7mm (6.01")

Part #	Watts	Volts	CFM	RPM	Bearing	Impeller	Noise	Connection	Weight
RF249	72	115	460	3400	Ball	Plastic	59db (A)	Screw	2.2kg

254mm x 254mm x 89mm (10" x 10" x 3.5")

- Mounting Centres 247mm (9.72")

Part #	Watts	Volts	CFM	RPM	Bearing	Impeller	Noise	Connection	Weight
RF250	35	115	547	1650	Ball	Plastic	55db (A)	Terminal	1.9kg
RF255	33	230	547	1650	Ball	Plastic	55db (A)	Terminal	1.9kg

Axial Fan Features:

- Die-cast Aluminum Housing
- Shaded Pole Motor
- Impedance Protection
- CSA & UL Approved.
- Operating Temp. Range -10°C to 70°C
- Metal or Plastic Impellers
- Sleeve or Ball Bearings

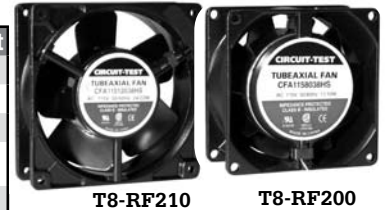

T8-RF210

T8-RF200



T8-RF230



T8-RF245



T8-RF250

Metal Fan Guards

Part #	Size
T8-CFG-60M	66mm
T8-CFG-80M	80mm
T8-CFG-92M	92mm
T8-CFG-120M	120mm
T8-CFG-150M	150mm
T8-CFG-254M	254mm

Plastic Fan Guards

Mounting: Plastic Tabs

Part #	Size
T8-CFG-80P	80mm
T8-CFG-120P	120mm

Note: T8-CFG-80M, 120M, 150M are also available in black. *



T8-CFC-T24

Axial AC Power Cords

Bare Wire - 2 Pin molded connection to bare wire leads.

Plug - 2 Pin molded connection to 2 prong plug.

Bare Wire	Description	Plug
T8-CFC-T24	60.96cm (24") Cord	T8-CFC-T24P
T8-CFC-T48	121.92cm (48") Cord	T8-CFC-T48P
T8-CFC-T72	182.88cm (72") Cord	T8-CFC-T72P

Rotation determined opposite shaft end
Double shaft determined at lead end

Shaft length measured from hub
face to shaft end

Flue Exhaust Blowers

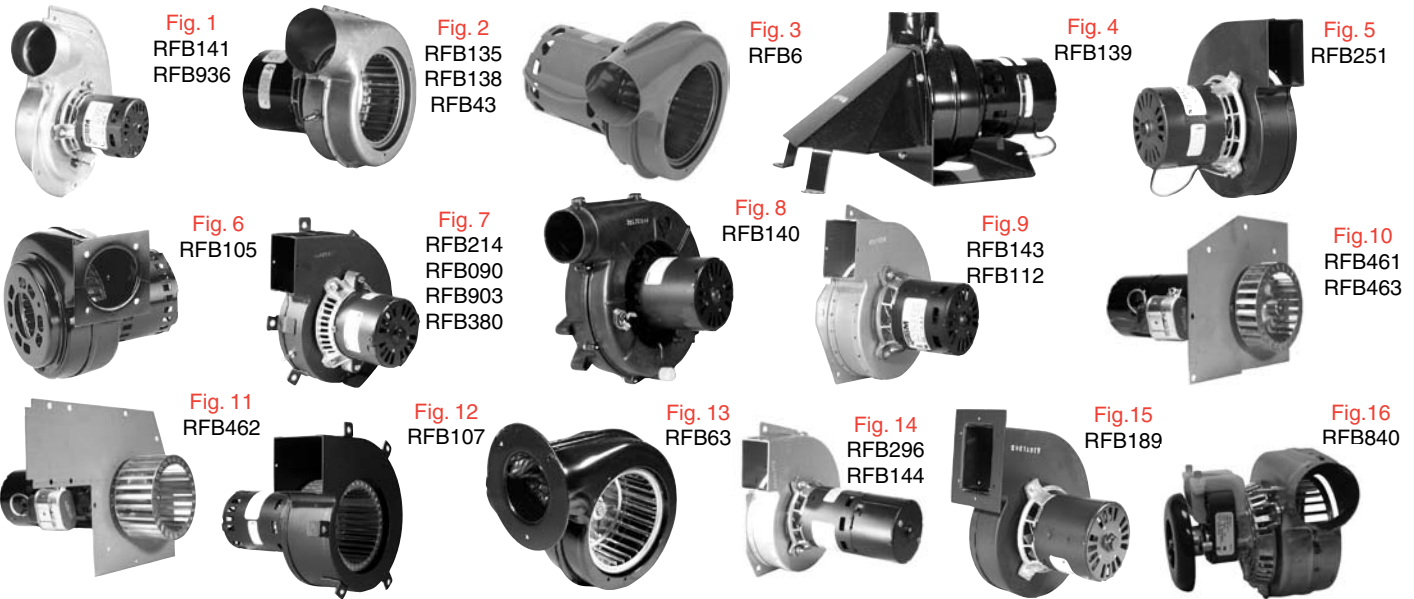

Blowers

Part #	HP	Speed/RPM	Volts	Amps	Rot	Type	Const.	Bearing	Comment	Fig
RFB141	1/65	1/2800	115	1.00	C.C.W.	S.P.	OPEN	BALL	KEEPRITE, INTER-CITY,FASCO 7021-8741	1
RFB135	1/65	1/3000	115	0.70	C.W.	S.P.	OPEN	SLEEVE	LENNOX 19J04,FASCO 7121-8812	2
RFB138	1/65	1/3000	115	0.70	C.W.	S.P.	OPEN	SLEEVE	LENNOX 19J04,FASCO 7021-8657	2
RFB936	1/60	1/2800	115	1.00	C.C.W.	S.P.	OPEN	SLEEVE	DUCANE 20093601, 20282002	1
RFB6	1/60	1/3000	230	0.55	C.W.	S.P.	OPEN	BALL	FRANKLIN 80280,	3
RFB139	1/55	1/2970	115	0.95	C.C.W.	S.P.	OPEN	SLEEVE	RHEEM, FASCO 7062-7577	4
RFB251	1/50	1/3000	115	1.10	C.W.	S.P.	OPEN	BALL	(135CFM) YORK 02-62510000,02-6525120C000	5
RFB43	1/50	1/3000	115	0.80	C.W.	S.P.	OPEN	SLEEVE	LENNOX G24 MID EFFICIENCY,43K41	2
RFB214	1/50	1/3000	115	1.10	C.C.W.	S.P.	OPEN	SLEEVE	RHEEM - RUDD	7
RFB105	1/50	1/3200	230	0.40	C.W.	S.P.	OPEN	SLEEVE	KEEPRITE 1050144, JA1M109NS,HEIL QUAKER INTERCITY WHIRPOOL	6
RFB090	1/50	1/3000	115	1.10	C.C.W.	S.P.	OPEN	SLEEVE	RHEEM 70-21496-01,7021-5239, MAGNETEK JA1M102	7
RFB140	1/50	1/3400	115	1.49	C.C.W.	S.P.	OPEN	SLEEVE	GOODMAN, JANITROL,FASCO 7021-9087	8
RFB840	1/50	1/3000	115	1.30	CW	S.P.	OPEN	BALL	88K8401, 85L49,	16
RFB903	1/45	1/3000	115	1.10	C.C.W.	S.P.	OPEN	SLEEVE	NORDYNE, FRIGIDAIRE, MILLER,G5RC, G6RC, G1, G4 HI. EFF.	7
RFB143	1/45	1/3000	115	0.95	C.C.W.	S.P.	OPEN	SLEEVE	TRANE, FASCO 7012-8428	9
RFB112	1/45	1/3000	115	1.30	C.C.W.	S.P.	OPEN	SLEEVE	OLSEN 26986,UE JA1M209NS	9
RFB461	1/40	1/3200	460	0.30	REV.PLUG	P.S.C.	OPEN	BALL	YORK	10
RFB462	1/40	1/3200	460	0.30	REV.PLUG	P.S.C.	OPEN	BALL	YORK	11
RFB107	1/40	2/3350	230	0.30	C.W.	P.S.C.	OPEN	SLEEVE	KEEPRITE 101070, 107701,,1097245, REEM-RUDD 107070	12
RFB380	1/40	1/2800	208/230	0.25	C.C.W.	P.S.C	OPEN	BALL	TRANE X38040036037	7
RFB296	1/40	1/3000	460	0.30	C.C.W.	S.P.	OPEN	SLEEVE	YORK 26-29600,C/W ROUND & SQUARE FLANGE	14
RFB144	1/40	1/3000	208/230	0.50	C.C.W.	S.P.	OPEN	SLEEVE	YORK 024-24115-705,	14
RFB189	1/40	1/3000	115	1.00	C.C.W.	S.P.	OPEN	SLEEVE	RHEEM 09-189,UE JA1M161NS	15
RFB463	1/40	1/3200	460	0.37	C.W.	S.P.	OPEN	BALL	YORK 024-24115-019B, 018B,	10
RFB63	1/40	1/3000	208/230	0.45	C.W.	S.P.	OPEN	BALL	FASCO A063 U464E,YORK 26-22239	13

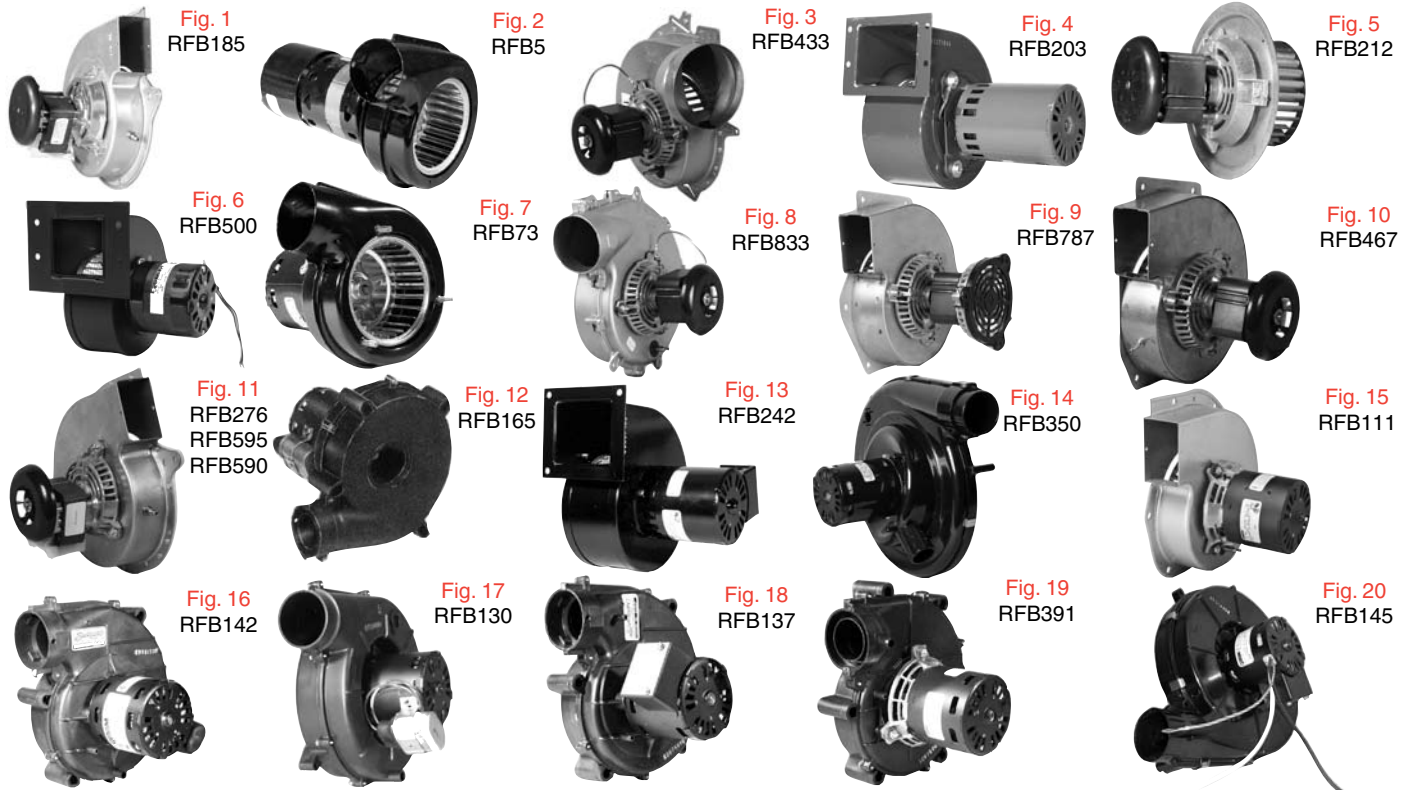

Part #	HP	Speed/RPM	Volts	Amps	Rot	Type	Const.	Bearing	Comment	Fig
RFB185	1/35	1/3000	115	1.30	C.W.	S.P.	OPEN	SLEEVE	GOODMAN-JANITROL,B1859005	1
RFB5	1/35	1/3000	115/230	0.51	C.W.	S.P.	OPEN	BALL	YORK 26-22239, 26-20224,U.E. 408, 512, FASCO A063	2
RFB433	1/35	1/3000	115	1.50	CW	S.P.	OPEN	BALL	1014433,	3
RFB203	1/30	1/3000	230	0.90	C.C.W.	S.P.	OPEN	BALL	ARMSTRONG 203884B002,OLSEN ROOFTOP	4
RFB212	1/30	1/3000	115	1.60	C.C.W.	S.P.	OPEN	BALL	CARRIER HC21 ZE117-13,818984753	5
RFB500	1/30	1/2860	115	1.10	C.C.W.	S.P.	OPEN	SLEEVE	DUNDAS FOUNDRY COOLER,BLOWER FAN, FASCO D500	6
RFB73	1/30	1/3000	115/230	0.82	C.W.	S.P.	OPEN	BALL	JANITROL 4429-32, YORK 2000,AMANA-TAPPAN, TRANE 38040252	7
RFB833	1/30	1/3000	115	1.60	CCW	S.P.	OPEN	BALL	1013833,	8
RFB787	1/30	1/3000	115	1.00	CW	S.P.	OPEN	BALL	787P01,	9
RFB467	1/30	1/3000	115	1.70	CW	S.P.	OPEN	BALL	29467,	10
RFB276	1/30	1/3000	115	1.40	CW	S.P.		BALL	0131M00002P,	11
RFB595	1/30	1/3000	115	1.40	CW	S.P.		BALL	B18590-05,	11
RFB590	1/30	1/3000	115	1.40	CW	S.P.		BALL	B40590-00,	11
RFB165	1/25	1/3450	115	0.70	C.C.W.	P.S.C.	OPEN	SLEEVE	YORK 7062-3958,COLEMAN 2940391P	12
RFB242	1/25	1/3200	115	1.30	C.C.W.	S.P.	OPEN	SLEEVE	ICP, KEEPRITE 1011350	13
RFB350	1/25	1/3450	115	0.80	C.W.	P.S.C.	OPEN	BALL	INTERCITY, KEEPRITE MID EFF.,1011350	14
RFB111	1/25	1/3000	115	1.20	C.C.W.	S.P.	OPEN	SLEEVE	OLSEN 26607, HSS-BHS,	15
RFB142	1/25	1/3450	115	0.70	C.C.W.	P.S.C.	OPEN	SLEEVE	RHEEM 70-22162-81,FASCO 7062-1881	16
RFB130	1/25	1/3450	115	0.70	C.C.W.	P.S.C.	OPEN	SLEEVE	TRANE, FASCO 7062-9064	17
RFB137	1/25	1/3450	115	0.70	C.C.W.	P.S.C.	OPEN	SLEEVE	YORK, FASCO 7062-2442	18
RFB391	1/25	1/3200	115	1.30	C.C.W.	S.P.	OPEN	SLEEVE	COLEMAN DORNBACK 7021-6759,7021-5478	19
RFB145	1/25	1/3450	115	0.70	C.W.	P.S.C.	OPEN	BALL	KEEPRITE 1009518, 1010527,INTERCITY 100924, FASCO A145, Gaskets Included	20

Rotation determined opposite shaft end
Double shaft determined at lead end

Shaft length measured from hub
face to shaft end

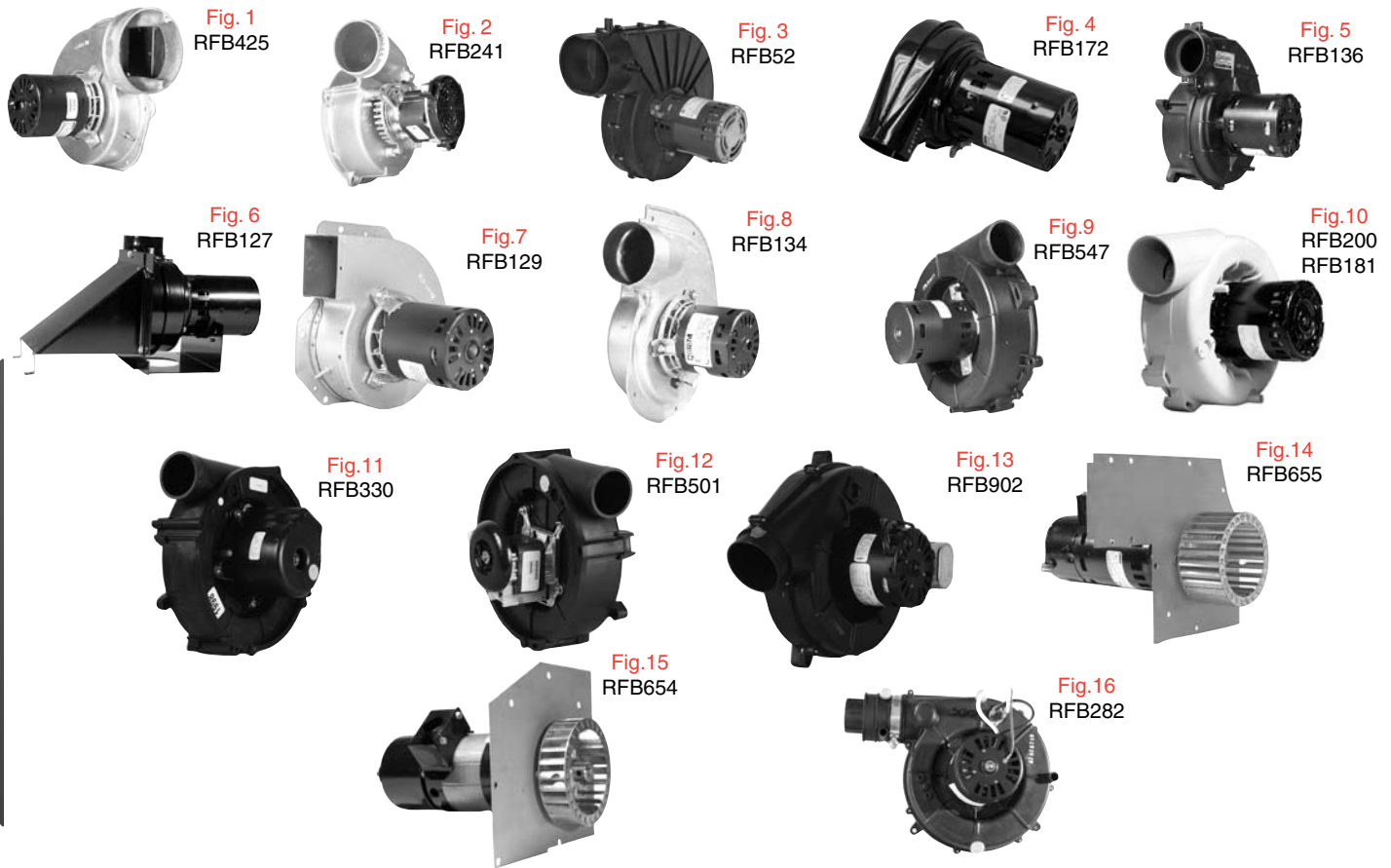

Blowers

Part #	HP	Speed/RPM	Volts	Amps	Rot	Type	Const.	Bearing	Comment	Fig
RFB425	1/23	1/3000	115	1.40	C.W.	S.P.	OPEN	SLEEVE	ARMSTRONG-JOHNSON,40425-002	1
RFB241	1/20	1/3400	115	1.71	C.C.W.	S.P.	OPEN	SLEEVE	RHEEM-RUUD, WEATHER KING,70-24157-03, 70-22838-02	2
RFB52	1/20	1/3450	115	0.85	C.C.W.	P.S.C.	OPEN	BALL	CLARE V52, M053,	3
RFB172	1/20	1/3200	115	1.30	C.C.W.	S.P.	OPEN	SLEEVE	GSW 63172,	4
RFB136	1/20	1/3450	115	0.75	C.C.W.	P.S.C.	OPEN	SLEEVE	RHEEM,FASCO 7062-3861	5
RFB127	1/20	1/3200	115	1.30	C.W.	S.P.	OPEN	SLEEVE	G.S.W. 63172,FASCO 7021-8247	6
RFB129	1/20	1/3480	115	1.95	C.C.W.	S.P.	OPEN	SLEEVE	AMANA, FASCO 7021-9064	7
RFB134	1/20	1/3000	115	1.50	C.C.W.	S.P.	OPEN	SLEEVE	KEEPRITE 1708607,INTER- CITY,FASCO 7021-9335, 7021-8735	8
RFB547	1/20	1/3400	115	1.80	C.W.	S.P.	OPEN	BALL	LENNOX G26, UE JB1N062N, LAMB 116547-07, Gaskets Included	9
RFB200	1/20	1/3200	115	1.20	C.C.W.	S.P.	OPEN	BALL	OLSEN, AIRCO 20082, 27612, HCS-2 60,75,81,90, 117592-00	10
RFB181	1/20	1/3200	115	1.20	C.W.	S.P.	OPEN	BALL	OLSEN, AIRCO 18102, 27614,HCS-2 60,75,81,90, 117591-00, Gaskets Included	10
RFB330	1/20	1/3000	115	2.40	CCW	S.P.	OPEN	BALL	330701-701, 329148-701,	11
RFB501	1/20	1/3000	115	2.80	CW	S.P.	OPEN	BALL	22307501,	12
RFB902	1/19	1/3450	115	0.70	C.C.W.	P.S.C.	OPEN	BALL	NORDYNE, FRIGIDAIRE MILLER,G5RC, G6RC, G1, G4, 902977	13
RFB655	1/16	1/3430	230/460	1.20	C.W.	S.P.	OPEN	BALL	YORK	14
RFB654	1/16	1/3430	230/460	1.20	C.W.	S.P.	OPEN	BALL	YORK	15
RFB282	1/16	1/3000	115	1.10	C.C.W.	S.P.	OPEN	SLEEVE	DUCANE 20282001	16

Continued next page

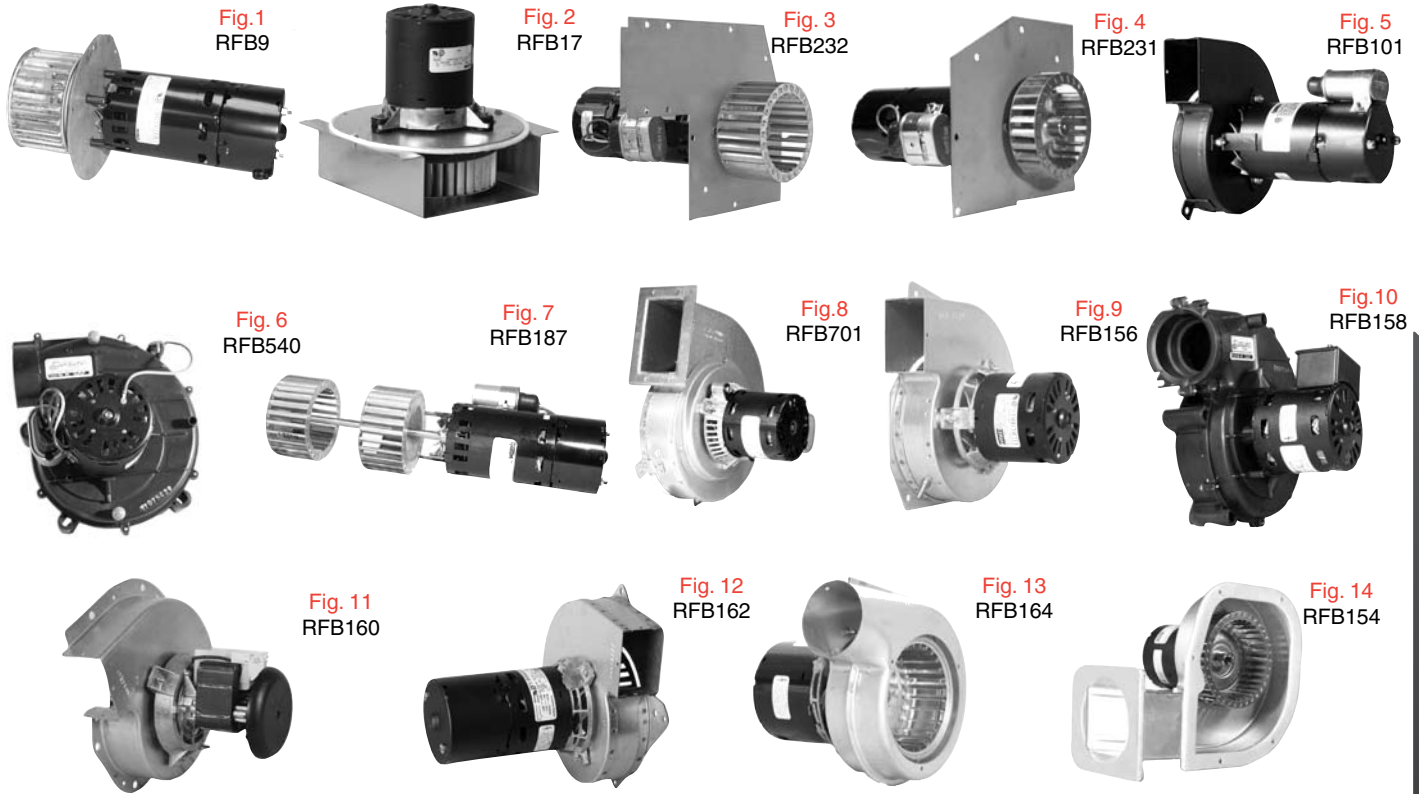

Blowers

continued from previous

Part #	HP/CFM	Speed/RPM	Volts	Amps	Rot	Type	Const.	Bearing	Cross	Fig
RFB9	1/15	1/3000	208/230	1.10	C.C.W.	S.P.	OPEN	BALL	KEEPRITE,501493	1
RFB17	1/15	1/3000	115	2.00	C.C.W.	S.P.	OPEN	SLEEVE	CLARE V17,	2
RFB232	1/12	1/3200	230	0.60	REV.PLUG	P.S.C.	OPEN	BALL	YORK	3
RFB231	1/12	1/3200	230	0.60	REV.PLUG	P.S.C.	OPEN	BALL	YORK	4
RFB101	1/12	1/3200	208/230	0.50	C.C.W.	P.S.C.	OPEN	SLEEVE	W/END SWITCH,LENNOX 23G8101	5
RFB540	1/10	1/3450	115	0.70	C.C.W.	P.S.C.	OPEN	SLEEVE	DUCANE, LENNOX, AIR-FLO,20054001, 20000101	6
RFB187	1/10	1/3400	460	0.30	C.W.	P.S.C.	S.E.	BALL	10 TON YORK DICG120N16525A, C/W A8666 & A8667 INSTALLED	7
RFB701	1/10	1/3200	208/230	0.60	C.C.W.	P.S.C.	OPEN	BALL	LENNOX 98G8701,	8
RFB156	75	1/3000	115	1.10	C.C.W.	S.P.	OPEN	SLEEVE	EVCON 2702-321	9
RFB158	75	1/3450	115	0.70	C.C.W.	P.S.C.	OPEN	SLEEVE	AMANA HIGH EFF.	10
RFB160	75	1/3000	115	1.60	C.C.W.	S.P.	OPEN	SLEEVE	AMANA MID EFF.	11
RFB162	80	1/3000	208/230	0.50	C.C.W.	S.P.	OPEN	SLEEVE	w/END SWITCH,	12
RFB164	80	1/3000	115	0.80	C.W.	S.P.	OPEN	SLEEVE	LENNOX 46K4101	13
RFB154	80	1/3000	115	1.20	C.C.W.	S.P.	OPEN	SLEEVE	c/w DISCHARGE HORN,	14

Rotation determined opposite shaft end
Double shaft determined at lead end

Shaft length measured from hub
face to shaft end



Fig. 1
RB89
RB85



Fig. 2
RB87
RB88



Fig. 3
RB91



Fig. 4
RB571



Fig. 5
RB83



Fig. 6
RB81



Fig. 7
RB735



Fig. 8
RB60



Fig. 9
RB21K



Fig. 10
RB006



Fig. 11
RB130

Part #	CFM	Spd/RPM	Volts	Amps	Rot	Type	Const.	Bearing	Cross	Fig
RB89	23	1/2050	115	0.46	C.C.W.	S.P.	OPEN	SLEEVE	SELKIRK	1
RB85	23	1/2050	115	0.46	C.C.W.	S.P.	OPEN	SLEEVE	SELKIRK	1
RB87	35	1/1900	115	0.60	C.C.W.	S.P.	OPEN	SLEEVE	SELKIRK	2
RB88	35	1/1900	115	0.60	C.C.W.	S.P.	OPEN	SLEEVE	SELKIRK	2
RB91	40	1/1500	115	0.30	C.C.W.	S.P.	OPEN	SLEEVE	HUNTER WALL HEATER 917254	3
RB571	45	1/1800	115	0.38	C.C.W.	S.P.	OPEN	SLEEVE	73 CFM, NORDICA	4
RB83	53	1/2400	115	0.92	C.C.W.	S.P.	OPEN	SLEEVE	QUADRA FIRE FREE STANDING WOODSTOVE	5
RB81	53	1/2400	115	0.92	C.C.W.	S.P.	OPEN	SLEEVE	HEARTH & HOME TECH. FK-GAS	6
RB735	60	1/1500	115	0.36	C.C.W.	S.P.	OPEN	SLEEVE	HUNTER, VALOR, NAPOLEON FASCO 7063-7736	7
RB60	60	1/3200	115	1.00	C.W.	S.P.	T.E.	SLEEVE	ELECTROHOME 2810-005-052, EM60	8
RB21K	80	1/1800	115	0.75	C.C.W.	S.P.	OPEN	SLEEVE	HEATILATOR FK21, GFK21 NOVUS 30	9
RB006	81	1/2800	115	1.40	C.C.W.	S.P.	OPEN	SLEEVE	OSBURN FD006-1600 INSERTS 1800, 2200, 2400 STOVES	10
RB130	85	1/2800	115	1.50	C.W.	S.P.	OPEN	BALL	SINGLE BLOWER FK30 FS32DV	11

Continued next page

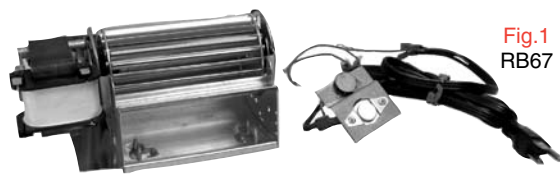

Fig.1
RB67



Fig.2
RB34



Fig.3
RB267



Fig.4
RB66
RB82



Fig.5
RB86
RB61



Fig.6
RB944



Fig.7
RB166



Fig.8
RB37



Fig.9
RB59



Fig.10
RB58



Fig.11
RB62

Blowers

continued from previous

Part #	CFM	Spd/RPM	Volts	Amps	Rot	Type	Const.	Bearing	Comment	Fig
RB67	100	1/2100	115	0.40	C.C.W.	S.P.	OPEN	SLEEVE	HEATILATOR, SECURITY	1
RB34	100	1/3200	115	0.88	C.W.	S.P.	OPEN	SLEEVE	VARIABLE SPEED SWITCH LARGE FLANGE	2
RB267	100	1/2100	115	0.40	C.C.W.	S.P.	OPEN	SLEEVE	HEATILATOR, SECURITY	3
RB66	100	1/2100	115	0.40	C.W.	S.P.	OPEN	SLEEVE	SECURITY	4
RB86	100	1/2100	115	0.40	C.C.W.	S.P.	OPEN	SLEEVE	HEATILATOR, SECURITY	5
RB944	100	1/2800	115	0.77	C.C.W.	S.P.	OPEN	SLEEVE	POLARIS	6
RB166	105	1/3000	115	1.50	C.C.W.	S.P.	OPEN	SLEEVE	REGENCY 910-33/P WOOD FIRE PLACE	7
RB37	110	1/1400	115	.75	C.C.W.	S.P.	OPEN	SLEEVE	Z33FK, ZDV3320, ZDV6000 KINGSMAN	8
RB82	110	1/1500	115	0.50	C.W.	S.P.	OPEN	SLEEVE	CFM HE20, MAJESTIC INSTAFLAME	4
RB59	110	1/1500	115	0.50	C.C.W.	S.P.	OPEN	SLEEVE	GZ550, NAPOLEAN, WOLF STEEL CONTINENTAL	9
RB58	110	1/1500	115	0.50	C.C.W.	S.P.	OPEN	SLEEVE	GZ550, NAPOLEAN, WOLF STEEL CONTINENTAL	10
RB61	110	1/1500	115	0.50	C.C.W.	S.P.	OPEN	SLEEVE	NAPOLEAN, WOLF STEEL, Z33FK, Z36FK KINGSMAN, CONTINENTAL	5
RB62	111	1/2800	115	0.90	C.C.W.	S.P.	OPEN	SLEEVE	NAPOLEAN	11

Continued next page



Fig. 1
RB27



Fig. 2
RB38B



Fig. 3
RB50



Fig. 4
RB38

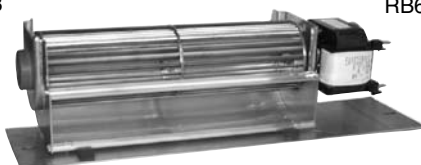

Fig. 5
RB63



Fig. 6
RB125



Fig. 7
RB35



Fig. 8
RB36



Fig. 9
RB84



Fig. 10
RB74K



Fig. 11
RB68



Fig. 12
RB108



Fig. 13
RB39



Fig. 14
RB64

Part #	HP/CFM	Speed/RPM	Volts	Amps	Rot	Type	Const.	Bearing	Cross	Fig
RB27	115	1/2400	115	0.92	C.C.W.	S.P.	OPEN	SLEEVE	FK26	1
RB38B	115	1/2400	115	0.92	C.W.	S.P.	OPEN	SLEEVE	GENERIC REPLACEMENT FIT ALL KINGSMAN 33,35,37&48	2
RB50	115	1/2400	115	1.20	C.C.W.	S.P.	OPEN	SLEEVE	c/w SPEED CNTRL & THERMAL SWITCH BOX	3
RB38	115	1/2400	115	0.92	C.W.	S.P.	OPEN	SLEEVE	GENERIC REPLACEMENT FIT ALL KINGSMAN 33,35,37&48	4
RB63	120	1/2800	115	0.70	C.W.	S.P.	OPEN	SLEEVE	INSTAFLAME, MAJESTIC, CFM REPLACES 53311 (FOR HE30TN)	5
RB125	125	1/3200	115	1.10	C.C.W.	S.P.	OPEN	SLEEVE	TOLOTTE, A125 2.5"x3.75" WHL., 125CFM	6
RB35	130	1/1250	115	0.86	C.W.	S.P.	OPEN	SLEEVE	KINGSMAN F35FK, FDV350, FV FDV5000, FDV4000 KINGSMAN	7
RB36	130	1/1250	115	0.86	C.W.	S.P.	OPEN	SLEEVE	Z36FK, ZDV3600, ZDV4200N KINGSMAN	8
RB84	130	1/1250	115	0.60	C.C.W.	S.P.	OPEN	SLEEVE	HUNTER 770, LENNOX FK2, KINGSMAN F35FK	9
RB74K	130	1/1250	115	0.86	C.W.	S.P.	OPEN	SLEEVE	HEATILATOR FK4, GFK4	10
RB68	130	1/1250	115	0.60	C.W.	S.P.	OPEN	SLEEVE	HUNTER 770 W/VAR SPD CTRL, FS, MNT BRKT	11
RB108	130	1/1250	115	0.86	C.W.	S.P.	OPEN	SLEEVE	OSBURN KA108	12
RB39	130	1/1250	115	0.86	C.W.	S.P.	OPEN	SLEEVE	w/THERMOSTAT SWITCH, WIRING HARNESS & SPEED CONTROL	13
RB64	130	1/1250	115	0.60	C.W.	S.P.	OPEN	SLEEVE	CFM HE30, MAJESTIC INSTAFLAME HE30	14

Continued next page

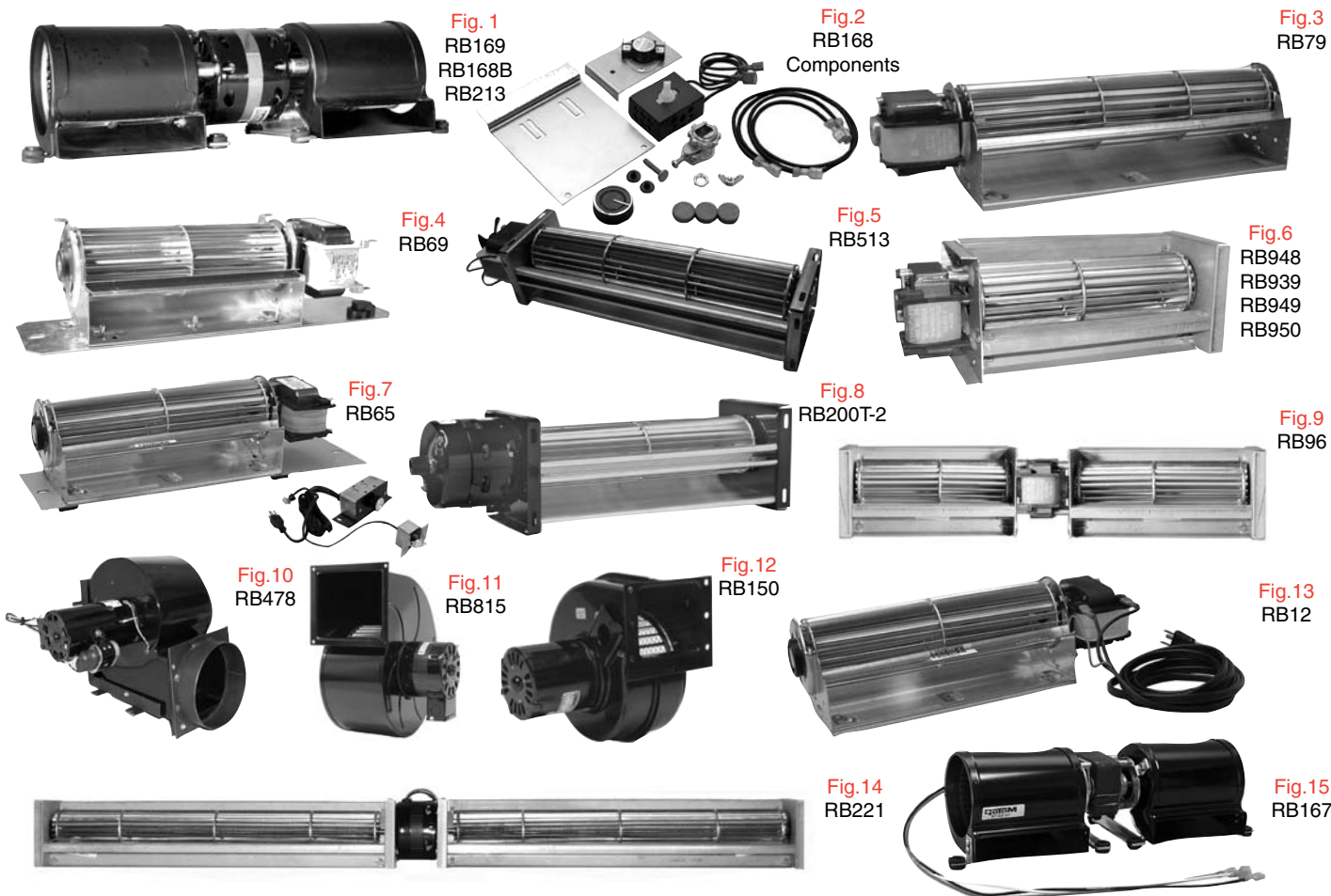

Blowers

continued from previous

Part #	HP/CFM	Speed/RPM	Volts	Amps	Rot	Type	Const.	Bearing	Cross	Fig
RB169	140	1/2900	115	1.10	C.C.W.	S.P.	OPEN	SLEEVE	HERITAGE	1
RB168	140	1/2900	115	1.50	C.W.	S.P.	OPEN	SLEEVE	HEAT & GLO 7002-1241,GFK160A ROYAL FK160	1+2
RB168B	140	1/2900	115	1.50	C.W.	S.P.	OPEN	SLEEVE	HEAT & GLO 7002-1241,GFK160A ROYAL FK160	1
RB79	150	1/1200	115	0.75	C.C.W.	S.P.	OPEN	SLEEVE	UNIVERSAL	3
RB69	150	1/1200	115	0.75	C.W.	S.P.	OPEN	SLEEVE	UNIVERSAL	4
RB513	162	1/2600	115	1.35	C.W.	S.P.	OPEN	SLEEVE	220 CFM, NORDICA FURNISHED W/COOLING FAN OSE	5
RB948	175	1/2800	115	0.80	C.C.W.	S.P.	OPEN	SLEEVE	POLARIS	6
RB939	180	1/2800	115	0.80	C.W.	S.P.	OPEN	BALL	GENERAL PURPOSE BLOWER	6
RB949	180	1/2800	115	0.80	C.C.W.	S.P.	OPEN	BALL	GENERAL PURPOSE BLOWER	6
RB950	180	1/2800	230	0.30	C.C.W.	S.P.	OPEN	BALL	GENERAL PURPOSE BLOWER	6
RB65	200	1/2800	115	0.70	C.W.	S.P.	OPEN	SLEEVE	C/W VARIABLE SPEED CONTROL, FAN SWITCH & MOUNTING PLATE	7
RB200T-2	200	3/1600	115	0.80	C.W.	S.P.	OPEN	SLEEVE	ELECTROHOME 2812-681-002, EB200T-2	8
RB213	212	1/2700	115	1.25	C.C.W.	S.P.	OPEN	SLEEVE	A212 3"x4" WHEEL, 212CFM	1
RB96	350	1/2800	115	0.90	C.W.	S.P.	OPEN	SLEEVE	GENERAL PURPOSE DOUBLE BLOWER REGENCY CHIMNEY BLOWER REGENCY	9
RB478	455	2/1550	115	1.60	C.C.W	P.S.C	OPEN	BALL	946556, FASCO A455	10
RB815	815	1/1040	115	5.60	C.C.W.	S.P.	OPEN	SLEEVE	70513853 WHEEL 8-1/16"x4-3/16"	11
RB150	1/35	1/1550	115	1.00				S.E	15007, 8253710702 Lennox, Earth Pellet Stove	12
RB12	1/3000	1/3000	115	0.84	C.W.	S.P.	OPEN	SLEEVE	CFM FK12 C/W 9' WALL PLUG	13
RB221	1/60	2/1550	115	0.60	C.C.W.	S.P.	OPEN	SLEEVE	UZY3 SECURITY , R408	14
RB167	135	2/2800	115	1.45	C.C.W.	S.P.	OPEN	SLEEVE	REGENCY 910-157P NORDICA DIA OSBURN, PACIFIC ENERGY	15

Continued next page

Rotation determined opposite shaft end
Double shaft determined at lead end

Shaft length measured from hub
face to shaft end



Fig. 1
RB4



Fig. 2
RB5



Fig. 3
RB75



Fig. 4
RB2
RB1

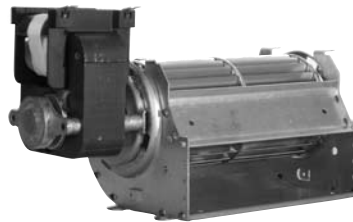

Fig. 5
RB21



Fig. 6
RB33
RB3



Fig. 7
RB74



Fig. 8
RB140



Fig. 9
RB200T



Fig. 10
RB265



Fig. 11
RB465



Fig. 12
RB245

Part #	HP	Spd/RPM	Volts	Amps	Rot	Type	Const.	Bearing	Cross	Fig
RB4	10	1/3000	115	0.80	C.W.	S.P.	T.E.	SLEEVE	FRANKLIN 76012, 80042, ELECTROHOME EB4	1
RB5	50	1/1600	115	0.40	C.C.W.	S.P.	T.E.	SLEEVE	FRANKLIN 80239, FASCO B30, ELECTROHOME EB5	2
RB75	75	1/3000	115	0.55	C.W.	S.P.	OPEN	SLEEVE	ELECTROHOME 2899-010-001, EB75	3
RB2	100	1/1550	115	0.47	C.W.	S.P.	OPEN	SLEEVE	FRANKLIN 76002, 80978, ELECTROHOME EB2	4
RB21K	100	1/2100	115	0.40	C.W.	S.P.	OPEN	SLEEVE	HEATILATOR FK21 NOVVS 30	5
RB33	100	1/3200	115	0.88	C.W.	S.P.	OPEN	SLEEVE	NEWMAC 204001 EB3 W/VARIABLE SPD SWITCH	6
RB3	100	1/3000	115	0.75	C.W.	S.P.	OPEN	SLEEVE	U.E.383, FASCO B24220	6
RB74K	130	1/1250	115	0.60	C.C.W.	S.P.	OPEN	SLEEVE	HEATILATOR FK4	7
RB140	140	1/2900	115	1.20	C.W.	S.P.	OPEN	SLEEVE	FRANKLIN 76001, 80195	8
RB1	200	1/2700	115	1.10	C.W.	S.P.	OPEN	SLEEVE	FRANKLIN 80748, 80981, ELECTROHOME EB1	4
RB245	245	1/1550	115	1.50	C.C.W.	S.P.	OPEN	SLEEVE	AMV245, AIRDEX	12
RB265	265	1/1550	115	1.86	C.C.W.	S.P.	OPEN	SLEEVE	FRANKLIN 80224, U.E.459, FASCO B45227, B45227	10
RB465	465	1/1550	115	2.50	C.C.W.	S.P.	OPEN	SLEEVE	FRANKLIN 80546, U.E.460, FASCO B45267	11

In-Line Air Duct Booster Fans

Air Duct Booster

Designed to be installed at any angle in the branch duct of under-ventilated rooms to increase either hot or cool air flow supply. One year limited warranty.

Control Options

Manual Control

- 115V Source - continuous operation.
- 115V Switch - manual ON/ OFF ctrl.

Automatic Control

- Wire to furnace fan.
- Wire to fan switch.
- Wire to a sail switch.
- Wire to a pressure switch.
- Wire to thermostat.



T9-DB68

Standard Air Duct Boosters



Part #	Description	Max Boosted CFM	Free Air CFM	Watts	Amps	dBA	Blade	Housing Length
T9-DB68	6" - 8" Universal Round	250	160	30	0.35	50	Polycarbonate	4"x11"
T9-DB6-2CR	6" Rnd Double Crimp	250	160	30	0.35	50	Polycarbonate	8"
T9-DB4	4" Round	80	40	30	0.30	52	Polycarbonate	6"
T9-DB5	5" Round	225	140	30	0.35	51	Polycarbonate	6"
T9-DB6	6" Round	250	160	30	0.35	50	Polycarbonate	6"
T9-DB8	8" Round	500	210	60	0.75	54	Polycarbonate	8"
T9-DB10	10" Round	650	300	120	1.50	55	Aluminium	8"
T9-DB12R	12" Round	800	650	120	1.50	55	Aluminium	8"
T9-MCM14	14" Round	1500	-	71	1.00	-	Aluminium	9"



T9-DB6

Blowers

Two Speed Air Duct Boosters



Part #	Description	Max Boosted CFM	Free Air CFM	Watts	Amps	dBA	Blade
T9-DB5-2	5" Round 2 Speed	180/270	90/140	30	0.35	50/52	Polycarbonate
T9-DB6-2	6" Round 2 Speed	200/300	160/180	30	0.35	50/52	Polycarbonate
T9-DB8-2	8" Round 2 Speed	500/600	210/250	60	0.85	50/55	Polycarbonate
T9-DB10-2	10" Round 2 Speed	650/900	300/460	135	1.70	56/59	Aluminium



T9-DB5-2

4-Pole Duct Boosters

Designed for larger ducts requiring commercial grade power and performance.

Part #	Description	Max Boosted CFM	Free Air CFM	Watts	Amps	dBA	Blade
T9-DB124	12" Round	1160	700	120	1.00	61	Aluminium
T9-DB144	14" Round	1580	900	120	1.00	61	Aluminium
T9-DB164	16" Round	1760	1100	120	1.00	54	Aluminium



4-Pole Duct Booster

Motorized Duct Dampers

Motorized Dampers

Normally Open Part #	Normally Closed Part #	Duct Dia.	Weight
T9-MD5-NO	T9-MD5-NC	5"	3.5
T9-MD6-NO	T9-MD6-NC	6"	3.5
T9-MD7-NO	T9-MD7-NC	7"	3.5
T9-MD8-NO	T9-MD8-NC	8"	4.0
T9-MD10-NO	T9-MD10-NC	10"	5.0
T9-MD12-NO	T9-MD12-NC	12"	6.0

Rotation determined opposite shaft end
Double shaft determined at lead end

Shaft length measured from hub face to shaft end

Features

- Available in normally open or normally closed 5", 6", 7", 8", 10" and 12" duct diameters.
- 8" Housing lengths.
- 24VAC, 0.25 amps.
- 100% Shutoff available.
- 3 Year limited warranty.



Thru The Wall Fans

ThruWall Room To Room Fans

The T9-TW8-2 and T9-TW208 ThruWall™ fans easily install in an interior wall to move heated or cooled air from one adjoining room to another, providing year round comfort.

- Ultra quiet operation.
- White polymeric grills can be painted to match decor.
- Telescoping housing (Galvanized steel) installs in frame walls from 3½" to 6½" thick.
- 10' Grounded cord.



T9-TW8-2



T9-TW208

1 Year Limited Warranty

ThruWall Fans

Part #	Features	Description	Volts	Amps	CFM	dBa	Weight
T9-TW8-2	• 3 Position, 2 Speed switch	Grill 9.75" Housing 7 5/8" dia.	115	0.85	160 CFM low spd 200 CFM high spd.	High: 55 Low: 49	5.0 lbs.
T9-TW208	• Built-in solid state speed control allows for fan speed & sound level control. • 360° Rotating grill allows airflow direction to be changed.	Front: 12.5"×10" Back: 9.75" dia. Housing: 8" dia.	115	1.0	100 CFM low spd 200 CFM high spd.	High: 55 Low: 49	5.0 lbs.

Door Frame Fan

Entreair® Door Frame Fan

The T9-DF100 is a safe, efficient and effective way to gently circulate warm or cool air from room to room.

- Quiet operation.
- Simple installation.
- In-line ON/OFF power switch.
- 10' Cord.
- Patented design.

1 Year Limited Warranty



T9-DF100 illustrated

Door Frame Fan

Part #	Description	Volts	Amps	CFM	Weight
T9-DF100	7" Grill diameter.	115	0.35	100 CFM.	2.0 lbs.

Register Air Booster

Equalizer® Register Booster

T9-EQ2 boosts airflow to problem areas for the comfort your family deserves. T9-EQ2 uses a powerful yet quiet fan to pull extra air out of weak registers, increasing airflow by up to 80%.

- Place and plug convenience.
- Boosts heating and air conditioning.
- 6' Cord w/ 2 prong plug.
- Fits over floor or wall registers up to 6" × 12".

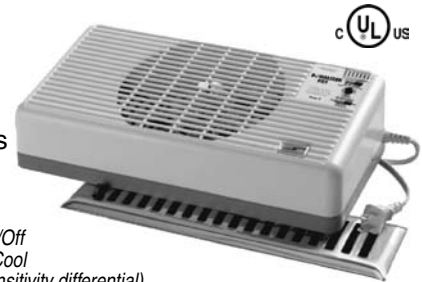

T9-EQ2
Manual - On/Off
Auto - Heat/Cool
(Adjustable thermostat & sensitivity differential)

Register Air Booster

Part #	Dimensions	Volts	Amps	Weight
T9-EQ2	12" × 6-¼" × 3¼"	115	0.35	2.25 lbs.

Duct Thermostat

Plug-In Duct Stat

The T9-DS45110 duct stat simplifies installation of in-line duct booster fans by eliminating electrical connections at the furnace.

- Economical and reliable automatic on/off control for in-line duct booster fans.
- Mounts on duct or wall to control ambient room temperature.
- Adjustable temperature range: 45° F (7° C) to 110° F (43° C) and differential.
- 6' Grounded cord.
- Year round use, ON/ OFF, AUTO heating and AUTO cooling .
- Controls various devices, including alarms, heat lamps, lights, louvers, etc.



T9-DS45110 illustrated

Plug-In Switch - Thermostatically Controlled

Part #	Description	Volts	Dimensions	Weight
T9-DS45110	5 Amp maximum load (replaceable 5A fuse).	115	5.50" × 3.25" × 2.25"	1.25 lbs.

Shaft length measured from hub face to shaft end

Rotation determined opposite shaft end
Double shaft determined at lead end

Blowers

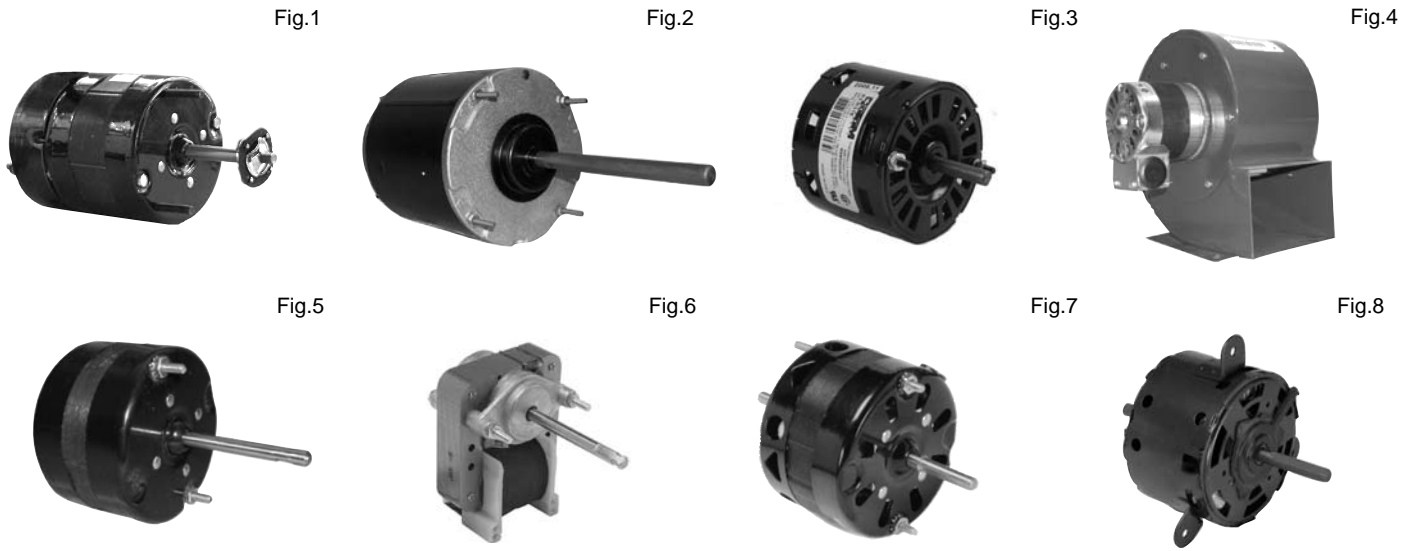

Acorn Woodstoves

Part #	HP	Spd/RPM	Volts	Amps	Rot	Type	Dia	Body	Shaft	Comment	Fig
R250	1/65	2/1550	115	0.50	CCW	SP	3.3"	3.7"	Hubless	605850M0	1

Addison-Comfortaire

Part #	HP	Spd/RPM	Volts	Amps	Rot	Type	Dia	Body	Shaft	Comment	Fig
R22442	1/4	2/1075	208/230	1.30	R.P.	5/370	5.5"	4.3"	6.0" x 1/2"	Cond. Fan	2
R22187	1/2	1/1075	208/230	2.80	R.P.	10/370	5.5"	5.2"	6.0" x 1/2"	Cond. Fan	2
R22016	1/2	2/1075	208/230	2.80	R.P.	10/370	5.5"	5.2"	6.0" x 1/2"	Cond. Fan	2
R32716	1/2	2/1075	460	2.00	REV.	10/370	5.5"	5.5"	6.4" x 1/2"	Cond. Fan	2

Air 2000

Part #	HP	Spd/RPM	Volts	Amps	Rot	Type	Dia	Body	Shaft	Comment	Fig
R316	1/20	1550	115	1.40	CCW	SP	3.3"	2.7"	-	HRV Motor	3

Airdex

Part #	HP	Spd/RPM	Volts	Amps	Rot	Type	Dia	Body	Shaft	Comment	Fig
RB245	1/25	1550	115	1.50	CCW	SP	3.3"	9.2"	-	AMV245	4

Air King

Part #	HP	Spd/RPM	Volts	Amps	Rot	Type	Dia	Body	Shaft	Comment	Fig
R503	1/130	1/1550	115	0.40	CW	S.P.	3.3"	1.90"	2.4"x1/4"	2108375001	5
R603	1/125	1/3000	115	0.58	CW	S.P.	Skel	0.62"	2.7"x7/32"	2108370033	6
R206	1/80	2/1550	115	0.50	CW	S.P.	3.3"	1.90"	1.5"x1/4"	Vent Fan	5
R222	1/75	1/1550	115	0.70	CCW	S.P.	3.3"	2.00"	1.2"x1/4"	2108375025	5
R415	1/65	1/1550	115	0.78	CCW	S.P.	3.3"	2.90"	2.3"x1/4"x2.3"	2108375034	7
R201	1/50	1/1550	115	0.90	CW	S.P.	3.3"	1.90"	2.2"x1/4"	2108375036	5

Airtemp

Part #	HP	Spd/RPM	Volts	Amps	Rot	Type	Dia	Body	Shaft	Comment	Fig
R760	1/8	3/1100	115	1.30	CW	PSC/12.5/370	5.5"	3.6"	2.0"x1/2"x2.8"	3525153	8
R22002	1/6	1/1075	208/230	1.30	CW	PSC/4/370	5.5"	3.5"	3.0"x1/2"	3775858	8
R52287	1/3	3/1310	208/230	2.90	CW	PSC/5/370	5.5"	4.5"	2.5"x1/2"x3.0"	Fasco D808	8

Rotation determined opposite shaft end
Double shaft determined at lead end

Shaft length measured from
hub face to shaft end

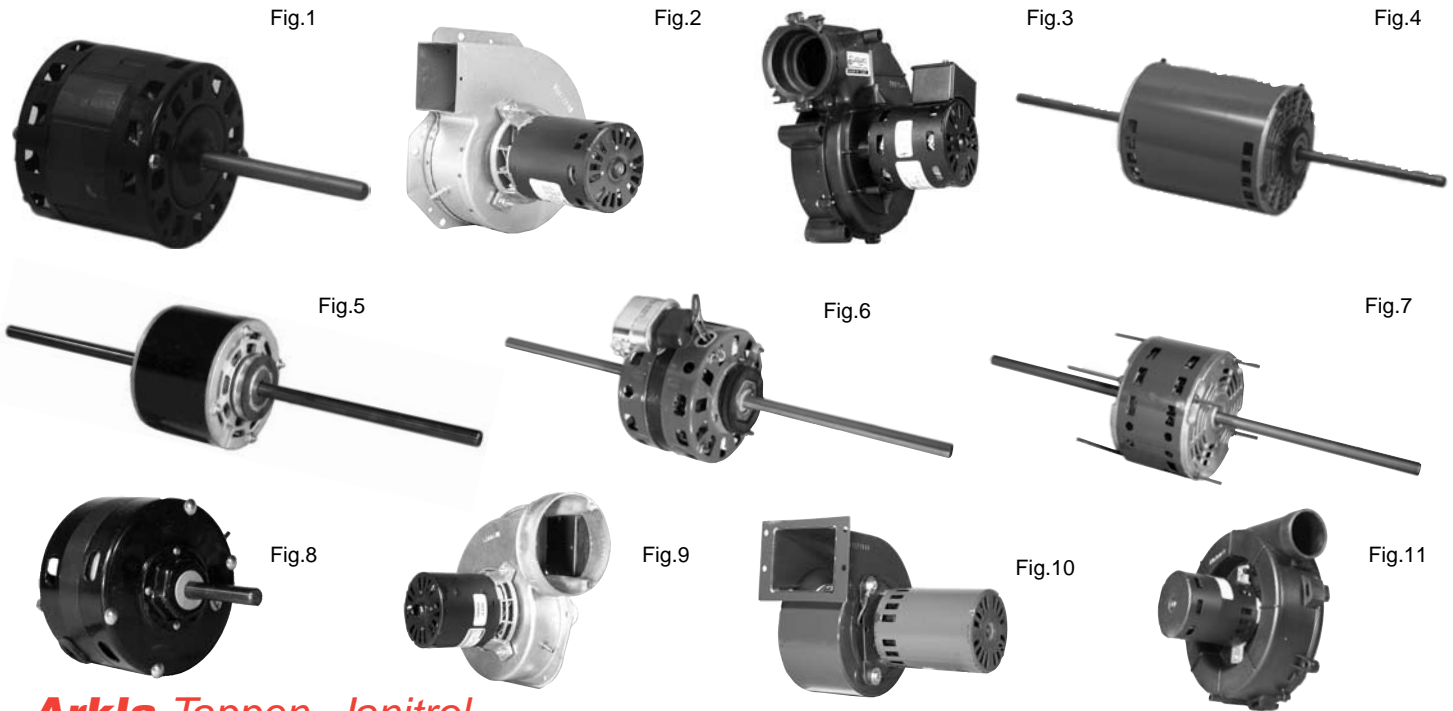

Arkla Tappen, Janitrol

Part #	HP	Spd/RPM	Volts	Amps	Rot	Type	Dia	Body	Shaft	Comment	Fig
R32317	1/3	1/825	115	4.80	CCW	5/370	5.5"	5.63"	2.5"×1/2"	B14506-393	1
R32237	1/3	1/285	208/230	3.00	CCW	5/370	5.5"	5.80"	2.7"×1/2"	B14506-396	1

Amana

Part #	HP	Spd/RPM	Volts	Amps	Rot	Type	Dia	Body	Shaft	Comment	Fig
RFB160	1/30	1/3000	115	1.60	CCW	SP	3.3"	6.0"	-	D69964-5	2
RFB158	1/25	1/3450	115	0.70	CCW	4/370	3.3"	6.4"	-	D98686-5	3
RFB129	1/20	1/3250	115	1.95	CCW	SP	3.3"	7.0"	-	11009001, c/c gasket	2
R52231	1/2	2/1075	208/230	4.00	REV	7.5/370	5.5"	7.0"	-	Neville RE128	4

American Air Filter

Part #	HP	Spd/RPM	Volts	Amps	Rot	Type	Dia	Body	Shaft	Comment	Fig
R2675	1/30	4/1075	208/230	0.40	CCW	PSC/inc	4.75"	3.8"	7.7"×1/2"×7.7"	02024224 (evap.)	5
R2375	1/20	1/1000	230	1.00	CW	SP	5.0"	2.9"	2.5"×1/2"	141 (condenser)	8
R2622	1/6 - 1/12	4/1550	115	3.20	Rev.	PSC/inc	5.0"	4.0"	7.40"×1/2"×7.40"	7184-0354	6
R2677	1/5-1/10	3/1625	115	2.80	CCW	PSC/inc	5.5"	3.55"	8.55"×1/2"×8.5"	7124-0103	7

Armstrong

Part #	HP	Spd/RPM	Volts	Amps	Rot	Type	Dia	Body	Shaft	Comment	Fig
RFB425	1/25	1/3000	115	1.40	CW	SP	3.3"	5.80"	-	40425-002	9
RFB203	1/20	1/3000	208/230	0.90	CCW	SP	3.3"	8.50"	-	2038843000, 203884B002	10
RFB547	1/20	1/3400	115	1.80	CW	SP	3.3"	5.80"	-	40404-003G-004, 40404-004, 2862-513-040, c/w gaskets	11
R2691	1/5	1/1075	208/230	1.50	CW	5/370	5.0"	4.00"	3.9"×1/2"	35035B001	6

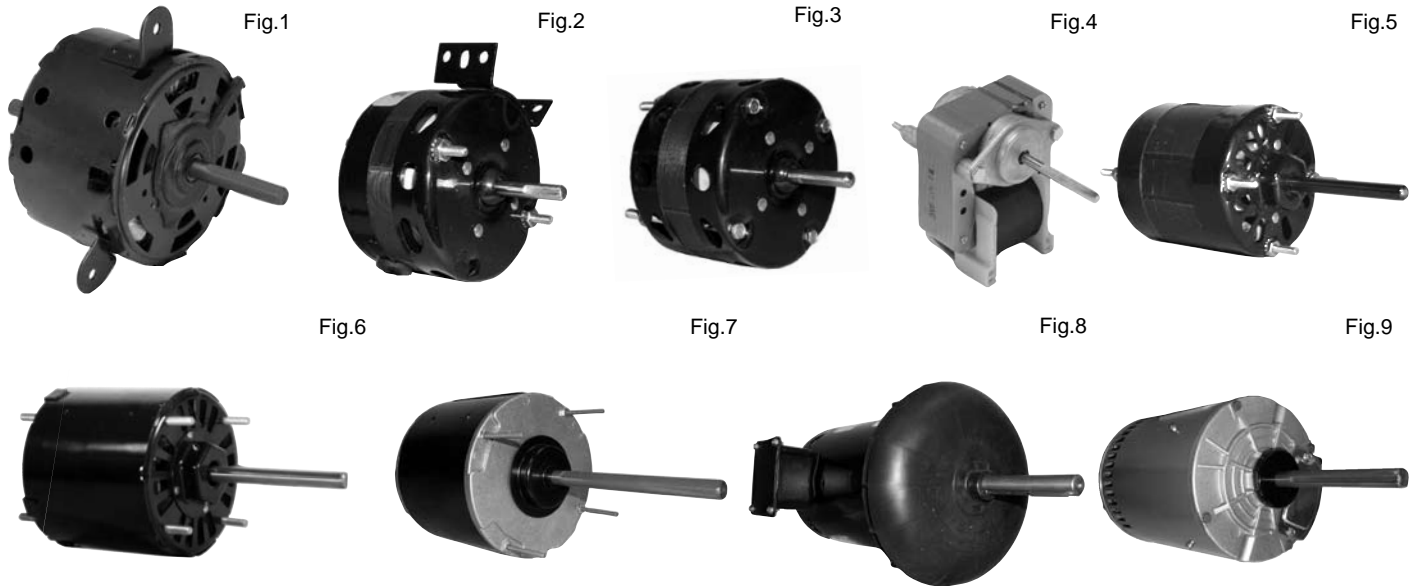

Belding

Part #	HP	Spd/RPM	Volts	Amps	Rot	Type	Dia	Body	Shaft	Comment	Fig
R756	1/12	3/1080	115	1.30	CCW	5/370	5.5"	3.5"	2.0"x1/2"x2.2"	R.A.C M8/M10 Chassis	1
R62160	1/3	3/1365	208/230	2.80	CCW	3/370	5.5"	4.4"	2.9"x1/2"x4.3"	R.A.C.	1

Blanchard Ness (cont. next page...)

Also See Bohn

Part #	HP	Spd/RPM	Volts	Amps	Rot	Type	Dia	Body	Shaft	Comment	Fig
R326	1/125	1/1550	115	0.50	CW	SP	3.3"	1.94"	1.4" x 1/4"	E01001,2,3	2
R511	1/100	1/1350	230	0.28	CW	SP	3.3"	2.10"	2.0"x1/4"	79105,79115	3
R302	1/100	1/1550	230	0.30	CW	SP	3.3"	1.94"	1.3" x 1/4"	E01004	3
R1014	1/65	1/3000	115	0.70	CW	SP	Skel	0.87"	1.25"x0.1811"	E1014, J238-087-8104	4
R605	1/55	1/2800	115	0.90	CW	SP	Skel	0.90"	1.7"x0.1811"	E310131, 79103	4
R130	1/25	1/1550	230	0.80	CW	SP	3.3"	2.72"	1.5"x5/16"	79106, 108, 113	2
R318	1/25	1/1550	115	1.50	CW	SP	3.3"	2.80"	2.8"x5/16"	79105, E1007	2
R358	1/20	1/1550	115	2.00	CCW	SP	3.3"	3.25"	2.8" x 5/16"	E01007,57,58	5
R359	1/20	1/1550	208/230	1.20	CCW	SP	3.3"	3.25"	2.8" x 5/16"	E01059	5
R1052	1/20	1/1550	115	2.00	CCW	SP	3.3"	3.0"	2.8"x 5/16"	E1052	6
R1053	1/20	1/1550	208/230	1.00	CCW	SP	3.3"	3.0"	2.8"x 5/16"	E1053	6
R22445	1/4	1/825	208/230	1.90	Rev	5/370	5.5"	4.90"	6.0"x1/2"	E1026	7
S1502	1/3	1/1075	208/230 /460	2.80	Rev	5/440	5.5"	7.30"	3.5"x1/2"	5015H	8
R22748	1/3	1/1075	208/230	2.60	Rev	5/370	5.5"	4.30"	6.0"x1/2"	E1022, E1025	7
R22745	1/2	1/1075	208/230	4.40	Rev	5/370	5.5"	4.80"	6.0"x1/2"	E1064	7
S1504	1/2	1/1075	208/230 /460	3.20	Rev	7.5/370	5.5"	9.2"	3.5"x1/2"	E1063,64	8
T1532	1/2	1/1140	208/230 /460	3.00	Rev	3 PH	5.5"	9.2"	3.5"x1/2"	Cond. Fan	8
T2532	1/2	3/1140	208/230 /460	2.70	Rev	3 Ph	6.5"	8.1"	5" x 5/8"	E01020, 1066	9
T2533	1/2	3/1140	575	1.00	Rev	3 Ph	6.5"	8.1"	5" x 5/8"	E01021	9
T1536	3/4	1/1140	575	1.50	Rev	3 PH	5.5"	11.0"	4.0"x5/8" KF	E1021,24, E5026,28	8
T1538	1	1/1140	208/230 /460	5.60	Rev	3 PH	5.5"	11.5"	4.0"x5/8" KF	Air Conditioner	8

Rotation determined opposite shaft end
Double shaft determined at lead end

Shaft length measured from
hub face to shaft end

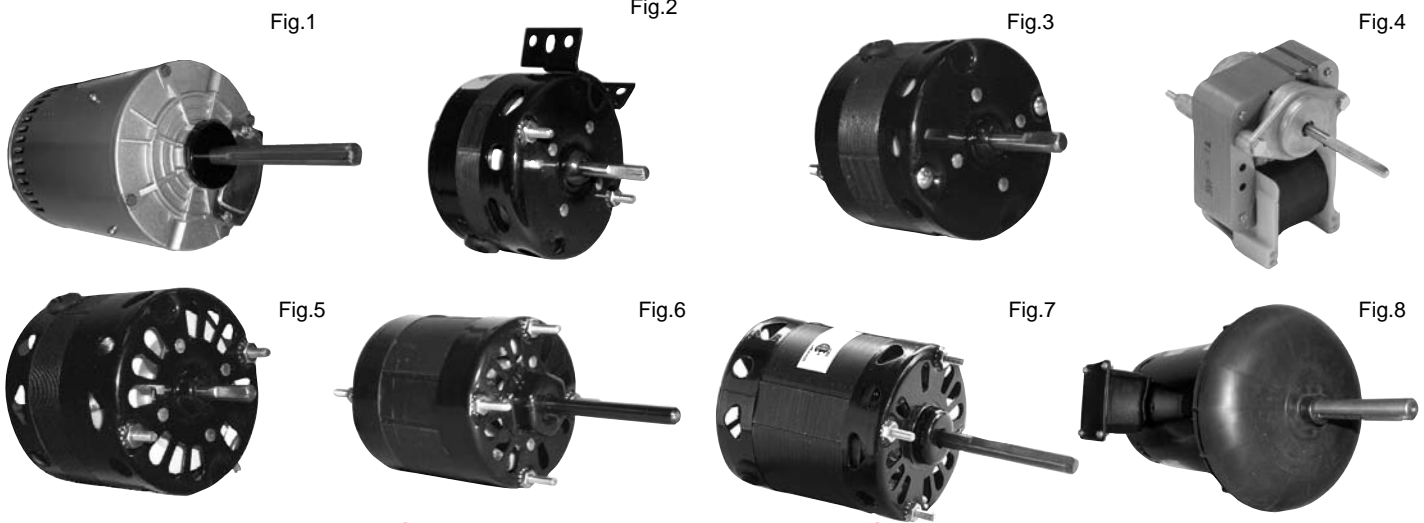

Blanchard Ness (cont. from previous page)

Also See Bohn

Part #	HP	Spd/RPM	Volts	Amps	Rot	Type	Dia	Body	Shaft	Comment	Fig
T2537	1	1/850	208/230	5.30	Rev	3 Ph	6.5"	11.10"	5" x 5/8"	E05026	1
T2537	1	1/850	460	5.30	Rev	3 Ph	6.5"	11.10"	5" x 5/8"	E05028	1
T2539	1	1/850	575	2.10	Rev	3 Ph	6.5"	11.10"	5" x 5/8"	E05027	1
T2544	2	1/1140	208/230 /460	7.20	Rev	3 Ph	6.5"	11.10"	5" x 5/8"	E05033	1
T2536	2	1/1140	575	2.70	CW	3 Ph	6.5"	11.10"	5" x 5/8"	E05034	1

Bohn

Also See Blanchard

Part #	HP	Spd/RPM	Volts	Amps	Rot	Type	Dia	Body	Shaft	Comment	Fig
R326	1/125	1/1550	115	0.50	CW	SP	3.3"	1.94"	1.4" x 1/4"	79101	2
R511	1/100	1/1350	230	0.35	CW	SP	3.3"	1.70"	2.0" x 1/4"	79105, 79115	3
R605	1/55	1/2800	120	1.0	CW	SP	Skel	0.96"	1.75" x 0.1811"	79103, 79104	4
R306	1/50	1/1550	115	0.65	CW	SP	3.3"	2.92"	1.1" x 1/4"	79102, 79114	5
R130	1/45	1/1550	230	0.80	CW	SP	3.3"	2.70"	1.5" x 5/16"	79106, 79108, 79113, 5001M	2
R332	1/25	1/1550	115	1.50	CW	SP	3.3"	2.69"	1.5" x 5/16"	79107, 112, 5001F, 11S, 20F	3
R318	1/20	1/1550	115	1.60	CW	SP	3.3"	2.75"	2.8" x 5/16"	79105, 5010S	2
R358	1/20	1/1550	115	2.00	CCW	SP	3.3"	3.25"	2.8" x 5/16"	5001L, 8S, 4L	6
R359	1/20	1/1550	208/230	1.20	CCW	SP	3.3"	3.25"	2.8" x 5/16"	5008T, 5034M	6
R313	1/15	1/1550	115	2.10	CCW	SP	3.3"	3.50"	3.0" x 5/16"	5034LS, 5008SS, U-572	7
R314	1/15	1/1550	208/230	1.30	CCW	SP	3.3"	3.50"	3" x 5/16"	5044MS, 5008TS, U-573	7
S1502	1/3	1/1075	200/230 /460	1.40	Rev	5/440	5.5"	7.30"	3.5" x 1/2"	5015H	8
S1504	1/2	1/1075	200/230 /460	4.00	Rev	7.5/440	5.5"	12.20"	3.5" x 1/2"	5002P, 5003P	8
T1532	1/2	1/1140	200/230 /460	1.50	Rev	3 Ph	5.5"	9.20"	3.5" x 1/2"	Condenser Fan	8
T2537	1	1/850	208/230 /460	5.30	Rev	3 Ph	6.5"	11.10"	5" x 5/8"	E5028	1
T2539	1	1/850	575	2.10	Rev	3 Ph	6.5"	11.10"	5" x 5/8"	E5027	1



Fig.1



Fig.2

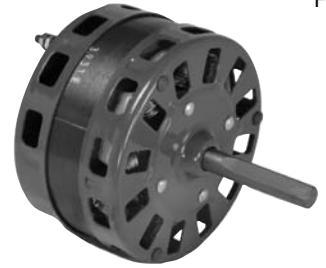

Fig.3



Fig.4



Fig.5



Fig.6



Fig.7

Broan

Part #	HP	Spd/RPM	Volts	Amps	Rot	Type	Dia	Body	Shaft	Comment	Fig
R611	1/300	1/1500	115	0.55	CW	SP	Skel	0.55"	1.7"x0.181"	3008001, 23303	1
R603	1/125	1/2400	115	0.52	CW	SP	Skel	0.65"	2.2"x7/32"	81058,96, 81795, 81826,27, 81993,94, 82230	1
R601	1/80	1/3000	115	0.70	CW	SP	Skel	0.90"	2.2"x1/4"	30080007,162	1
R322	1/60	1/1550	115	0.80	CW	SP	3.3"	2.00	1.3"x1/4"	30080111,112	2
R610	1/60	2/2400	115	1.00	CW	SP	Skel	0.90"	1.2"x7/32"	30080011,12, 51000, 52000	1
R605	1/55	1/2800	115	0.90	CW	SP	Skel	0.90"	1.7"x0.181"	Vent Fan	1
R467	1/25	1/1550	115	1.40	CW	SP	3.3"	3.10"	1.8"x5/16"x1.8"	30080059,30080060	2
R2343	1/9	1/1050	115	3.20	CCW	SP	5.0"	2.90"	2.6"x1/2"	1094343	3

Buck Stove

Part #	HP	Spd/RPM	Volts	Amps	Rot	Type	Dia	Body	Shaft	Comment	Fig
R1138	1/50	3/1550	115	0.88	CCW	SP	3.9"	4.00"	2.5"x5/16"	R22CCW270ZD, 7136-6045, 7163-5967	4
R1139	1/50	3/1550	115	0.88	CCW	SP	3.3"	2.80	2.5"x5/16"x1.12"	R22CW206MD	5

Caloritech

Part #	HP	Spd/RPM	Volts	Amps	Rot	Type	Dia	Body	Shaft	Comment	Fig
R210	1/50	1/1550	230	0.40	CCW		3.3"	2.40"	1.5"x1/4"	ELEC. HEATERS	6
R217	1/35	1/1450	230	0.50	CW		3.3"	2.40"	1.2"x1/4"	ELEC. HEATERS	6
R213	1/25	1/1550	115	1.40	CCW		3.3"	3.10"	1.7"x5/16"	ELEC. HEATERS	7
R303	1/25	1/1550	115	1.40	CCW		3.3"	3.84"	3.3"x5/16"	ELEC. HEATERS	7

Rotation determined opposite shaft end
Double shaft determined at lead end

Shaft length measured from
hub face to shaft end

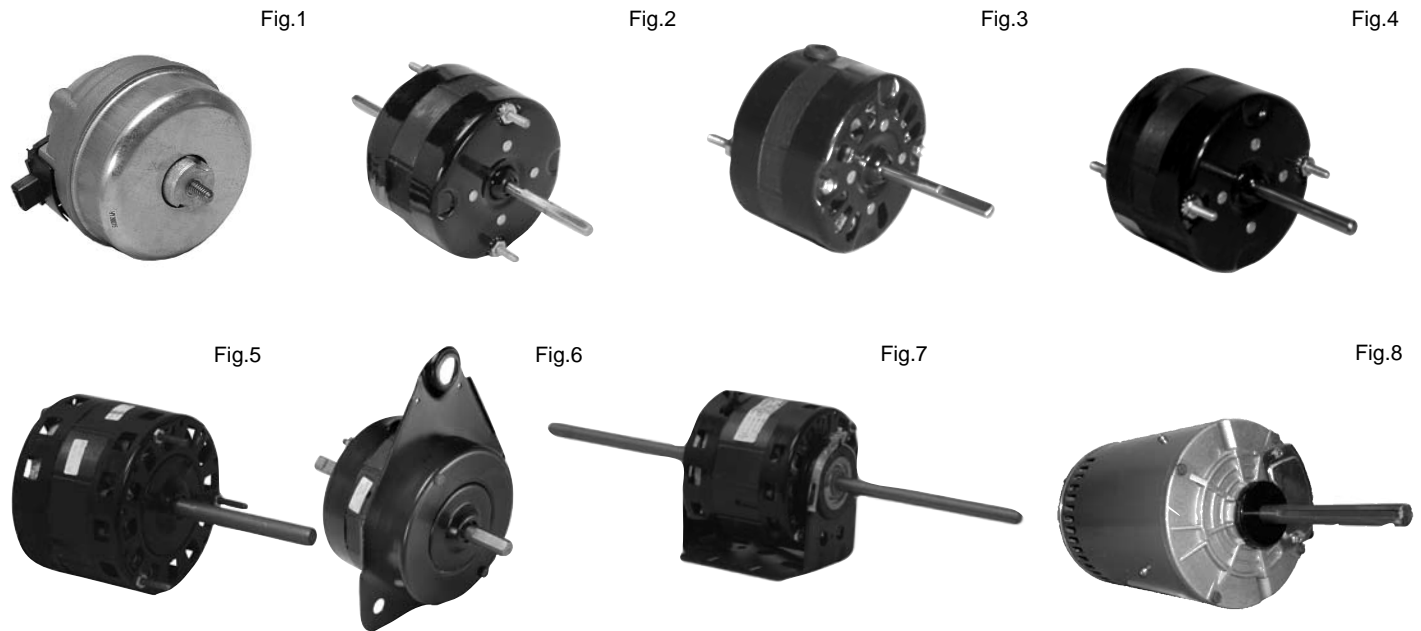

Camco GE, Hot Point, Westinghouse

Part #	HP	Spd/RPM	Volts	Amps	Rot	Type	Dia	Body	Shaft	Comment	Fig
R5109	2W	1/1550	115	0.25	CW	SP	3.5"	2.50"	Threaded	WR60X77, 5109	1
R416	1/60	1/1550	115	0.76	CCW	SP	3.3"	2.20"	2.3"x1/4"x2.3"	127C75672	2
R319	1/50	1/1430	115	0.90	CCW	SP	3.3"	2.10"	2.2"x1/4"	828C580J07,09	3
R201	1/50	1/1430	115	0.85	CW	SP	3.3"	2.20"	2.3"x1/4"	828C580J02,03	4
R510	1/45	1/1550	115	1.10	CW	SP	3.3"	2.25"	1.1"x1/4"x1.5"	Humidifier	2
R340	1/20	1/1550	230	0.90	CCW	SP	3.3"	3.15"	2.0"x5/16"	198A6404	3
R2388	1/5	1/1075	208/230	1.50	REV	5/370	5.0"	3.90"	3.5"x1/2"	322P757	5
R745	1/4	2/1330	208/230	1.90	CCW	5/370	5.0"	3.40"	1.8"x1/2"x2.8"	C275399, WJ94M116	6
R747	1/3	1/1625	208/230	2.30	CCW	6/370	5.0"	4.00"	7.2"x1/2"x7.2"	350A103H16	7

Canadian Armature

Part #	HP	Spd/RPM	Volts	Amps	Rot	Type	Dia	Body	Shaft	Comment	Fig
R203	1/70	1/1550	115	0.80	CCW	SP	3.3"	2.10"	1.5"x1/4"	Vent Fan	4

Cancoil

Part #	HP	Spd/RPM	Volts	Amps	Rot	Type	Dia	Body	Shaft	Comment	Fig
T2544	2	1/1140	208/230/460	7.20	Rev	3 PH	6.5"	11.10"	5.0"x5/8"	Cond. Fan	8
T2536	2	1/1140	575	2.70	CW	3 PH	6.5"	11.10"	5.0"x5/8"	Cond. Fan	8

Fig.1

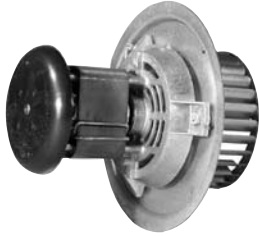

Fig.2



Fig.3



Fig.4



Fig.5



Fig.6



Fig.7



Fig.8



Carrier

Part #	HP	Spd/RPM	Volts	Amps	Rot	Type	Dia	Body	Shaft	Comment	Fig
RFB212	1/30	1/3000	115	1.60	CCW	SP	Skel	6.3"	-	HC21ZE117-13	1
RFM4	1/20	1/3000	115/230	1.80	CW	SP	3.3"	6.0"	2.0"x1/4"	HC24AU700	4
RFM5	1/20	1/3000	115/230	1.80	CCW	SP	3.3"	6.0"	2.0"x1/4"	HC24AU600,701	4
RFM580	1/20	1/3300	115	1.70	CCW	SP	3.3"	5.9"	2.3"x5/16"	HC27VE122	2
RFM3	1/16	1/3400	230/460	0.40	CCW	SP	3.3"	6.3"	2.3"x1/4"	U660	4
RFM653	1/16	1/3430	230/460	0.40	CW	SP	3.3"	6.3"	2.3"x1/4"	U653	4
RFM680	1/16	1/3450	115/230	1.90	Rev	SP	3.3"	4.9"	2.5"x1/4"	HC680001B	3
RFM232	1/16	1/3450	208/230	0.55	CW	PSC/Inc	3.3"	5.0"	2.9"x5/16"	HC30GB232	3
RFM462	1/16	1/3450	460	0.30	CW	PSC/Inc	3.3"	4.75"	3.3"x5/16"	HC30GB460	3
R52639	1/6	5/1075	208/230	0.80	CCW	4/370	5.5"	4.0"	2.5"x1/2"x3.7"	HC37CA230, 700	5
R22152	1/5	2/1050	208/230	1.30	Rev	5/440	5.5"	3.4"	4.0"x1/2"	HC37VE230,600	5
R22223	1/5	1/1075	230	1.30	CCW	5/370	5.5"	3.8"	2.8"x1/2"	HC37VE230,D842	5
R2391	1/5	3/1075	208/230	1.50	Rev	7.5/370	5.0"	3.9"	5.5"x1/2"	HC37DA651	6
R2390	1/5	3/1075	115	3.20	Rev	7.5/370	5.0"	3.9"	5.5"x1/2"	HC37DA115	6
R2387	1/5	4/1050	115	7.80	CCW	SP	5.0"	4.1"	4.6"x1/2"	HC37MA134, 138	6
R22844	1/4	1/1625	230	1.50	CCW	4/370	5.5"	4.3"	1.5"x1/2"	HC37ME268, OCA1024	5
R42440	1/4	2/1075	208/230	2.20	Rev	5/370	5.5"	4.1"	4.3"x1/2"	HC39MZ220, C39VE608, HC39ML706,	8
R22012	1/4	2/1075	208/230	2.50	Rev	5/370	5.5"	4.1"	4.0"x1/2"	HC41VE700, 701	8

Fig.1



Fig.2

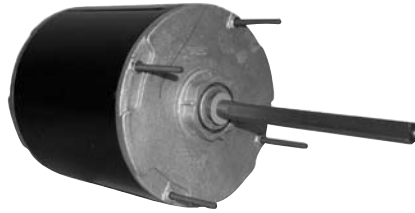

Fig.3



Fig.4



Fig.5



Fig.6



Carrier Cont...

Part #	HP	Spd/RPM	Volts	Amps	Rot	Type	Dia	Body	Shaft	Comment	Fig
S1502	1/3	1/1075	208/230 460	2.80	Rev	5/440	5.5"	7.3"	3.5"x1/2"	Condenser Fan	1
R32712	1/3	2/1075	460	1.10	Rev	5/370	5.5"	4.7"	6.4"x1/2"	Condenser Fan	2
R22015	1/3	2/1075	208/230	1.80	R.P.	7.5/370	5.5"	4.8"	6.0"x1/2"	Condenser Fan	2
R42415	1/3	4/1050	115	10.20	CCW	SP	5.5"	4.4"	4.6"x1/2"	BDP	3
R42310	1/3	4/1075	115	6.40	Rev	5/370	5.5"	4.8"	6.0"x1/2"	HC41SE117, P251-2307, 06	4
R42237	1/3	4/1075	208/230	4.80	Rev	10/440	5.5"	5.3"	6.0"x1/2"	HC41SE651 HC39SE651	4
R31718	1/2	1/1050	460	0.90	R.P.	10/370	5.5"	5.3"	3.3"x1/2"	Blower Motor	2
S1506	1/2	1/1075	575	1.50	Rev	7.5/440	5.5"	9.2"	3.5"x1/2"	Condenser Fan	1
S1504	1/2	1/1075	200/230 460	3.20	Rev	7.5/440	5.5"	9.2"	3.5"x1/2"	Condenser Fan	1
R22017	1/2	1/1075	208/230	4.00	CCW	7.5/370	5.5"	7.4"	4.5"x1/2"	HC44SL230	3
S1507A	1/2	1/1075	200/230 460	4.60	Rev	7.5/440	5.5"	6.3"	2.9"x1/2"	Condenser Fan	1
R42575	1/2	1/1140	575	1.00	Rev	3 PH	5.5"	7.9"	2.5"x1/2"	HD44ML461	5
T1532	1/2	1/1140	200/230 460	3.00	Rev	3 PH	5.5"	9.2"	3.5"x1/2"	Condenser Fan	1
R32716	1/2	2/1075	460	2.00	Rev	10/370	5.5"	5.5"	6.4"x1/2"	Condenser Fan	2
R52294	1/2	3/1075	208/230	3.20	CCW	7.5/370	5.5"	5.5"	7.0"x1/2"x2.8"	HC43CE230, 5KCP39MGB2	6

Fig.1



Fig.2



Fig.3



Fig.4



Fig.5



Fig.6



Fig.7



Fig.8



Carrier Cont...

Part #	HP	Spd/RPM	Volts	Amps	Rot	Type	Dia	Body	Shaft	Comment	Fig
S1510	3/4	1/1075	200/230 460	4.60	Rev	20/370	5.5"	10.8"	3.5"x1/2"	Condenser Fan	1
T1534	3/4	1/1140	200/230 460	4.00	Rev	3 PH	5.5"	11.0"	4.0"x5/8 KF	3 Phase Condenser Fan	1
S1174	3/4	1/1725	115/208 230	11.60	Rev	PSC/INC	5.5"	10.6"	2.0"x5/8" K	HC46DX610, 615	2
R42257	3/4	4/1075	208/230	5.40	R.P.	10/440	5.5"	5.5"	6.0"x1/2"	HC45SE651, P251-5701	3
R42241	3/4	4/1075	115	11.50	Rev	15/370	5.5"	7.3"	2.9"x1/2"	HC45SA114, P251-2702	7
R32050	3/4	3/1025	575	1.65	Rev	15/370	5.5"	6.5"	4.0"x1/2"	Commercial Rooftop	4
R32051	3/4	3/1075	460	2.15	Rev	15/370	5.5"	6.6"	4.0"x1/2"	HC45AL460	4
S1455	1	1/1075	575	2.10	CCW	30/370	5.5"	10.2"	3.5"x5/8" KF	Condenser Fan	1
S1453	1	1/1075	200/230 460	6.50	CCW	30/370	5.5"	10.2"	3.5"x5/8" KF	Condenser Fan	1
S1514	1	1/1075	200/230 460	6.40	Rev	25/370	5.5"	11.5"	4.0"x5/8"	HC51TE200	1
T2538	1	1/1140	208/230 460	6.60	Rev	3 PH	6.5"	11.1"	5.0"x5/8" KF	HD52VE214	5
R42242	1	3/1000	208/230	6.20	Rev	25/370	5.5"	7.3"	4.0"x5/8"	HC52AL230, 231, 232, HC52SE208	3
T2156	2	1/3450	208/230 460	5.20	Rev	3 PH	6.5"	11.6"	2.0"x5/8"	Condenser Fan	6
T2166	3	1/1750	208/230 460	8.20	Rev	3 PH	6.5"	12.6"	2.3"x7/8" K	Condenser Fan	6
T2164	3	1/3450	208/230 460	8.00	Rev	3 PH	6.5"	11.8"	2.3"x5/8" K	Condenser Fan	6
H980	3	1/1725	208/230 460	10.60	Rev	3 PH	6.5"	14.9"	2.3"x7/8"	HD60FK651	7
H979	5	1/1725	208/230 460	15.00	Rev	3 PH	6.5"	15.9"	2.3"x7/8"	HD60FK652	8
T2168	5	1/3450	208/230 460	13.00	Rev	3 PH	6.5"	11.9"	2.3"x7/8"	HD60AZ660	6

Rotation determined opposite shaft end
Double shaft determined at lead end

Shaft length measured from
hub face to shaft end

Fig.1

Fig.2

Fig.3

Fig.4

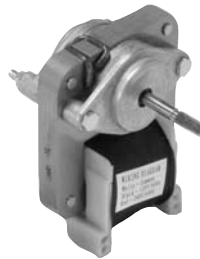

Fig.5

Fig.6

Fig.7

Fig.8



Chrysler

Part #	HP	Spd/RPM	Volts	Amps	Rot	Type	Dia	Body	Shaft	Comment	Fig
R760	1/8	3/1100	115	1.30	CW	SP	5.5"	3.6"	2.0"x1/2"x2.8"	3525153	1
R22002	1/6	1/1065	208/230	1.30	CW	SP	5.5"	3.5"	3.0"x1/2"	3775858	2

Chromalox

Part #	HP	Spd/RPM	Volts	Amps	Rot	Type	Dia	Body	Shaft	Comment	Fig
R611	1/300	1/1500	115	0.55	CW	SP	Skel	0.55"	1.7"x0.181"	12657-006,	3
R617	1/285	1/1900	208/230	0.22	CCW	SP	Skel	0.40"	1.1"x0.181"	12657-004, 005, 04290-004	3
R215	1/115	1/1550	230	0.22	CCW	SP	3.3"	2.10"	2.3"x6/16"	01513-005	4
R635	1/75	1/1700	208/230	0.95	CW	SP	Skel	1.50"	1.5"x1/4"	Construction Heater	3
R210	1/50	1/1550	230	0.40	CCW	SP	3.3"	2.40"	1.5"x1/4"	12519-002	5
R217	1/35	1/1450	230	0.50	CW	SP	3.3"	2.40"	1.2"x1/4"	02188-002	5
R212	1/30	1/1550	230	0.55	CCW	SP	3.3"	2.80"	3.5"x5/16"	01513-002,003,0 10,011,016	4
R480	1/30	1/1550	208/230	0.80	CCW	SP	3.3"	4.00"	2.4"x3/8"	A2001B	6
R2639	1/20	2/1075	208/230	0.42	CW	3/370	5.0"	3.34"	1.95"x1/2"	01103-100	7
R2928	1/12	1/1000	208/230	0.60	CCW	3/370	5.0"	3.09"	2.45"x1/2"	01103-202	7
R2671	1/10	3/1610	208/230	0.60	CCW	PSC/INC	5.0"	3.09"	8.6"x1/2"x8.6"	807-101, DE2E106N	7
R2929	3/16	1/1050	208/230	1.30	CW	4/370	5.0"	3.34"	2.45"x1/2"	01103-201	7
R52170	1/4	1/1725	208/230	2.10	Rev	SP	5.5"	7.00"	5.5"x1/2"x5.5"	078589	8

Fig.1



Fig.2



Fig.3



Fig.4



Fig.5



Fig.6



Fig.7



Fig.8



Clare Brothers

Part #	HP	Spd/RPM	Volts	Amps	Rot	Type	Dia	Body	Shaft	Comment	Fig
RFM11	1/20	1/3200	115	3.00	CCW		3.3"	3.6"	1.5"x5/16"	M045, High Efficiency	1
RFM12	1/15	1/3100	115	3.00	CCW		3.3"	5.8"	2.0"x5/16"	M046	2
RFB17	1/15	1/3100	115	2.00	CCW		3.3"	-	-	V17, V10, V25	3

Clawsey - Sohrt

Part #	HP	Spd/RPM	Volts	Amps	Rot	Type	Dia	Body	Shaft	Comment	Fig
R404	1/50	1/1550	115	0.85	CCW	SP	3.3"	2.84"	1.8"x5/16"	Space Heater	4

Climetec

Part #	HP	Spd/RPM	Volts	Amps	Rot	Type	Dia	Body	Shaft	Comment	Fig
R2198	1/14	3/820	115	1.30	CCW	7.5/370	5.0"	4.50"	3.4"x1/2"	C/W Plug	5
R2197	1/14	3/820	115	1.30	CCW	7.5/370	5.0"	4.50"	3.4"x1/2"	C/W Plug, 8.37" bolt circle	6
DD-029	1/8	5/1000	115	2.10	Rev	PSC/INC	5.5"	3.61"	5.0"x1/2"	L350, L450, L600, DA3E200, DA3F100, DA3G142, R2299	7

Climate Master

Part #	HP	Spd/RPM	Volts	Amps	Rot	Type	Dia	Body	Shaft	Comment	Fig
T2541	1	1/1140	575	1.70	Rev	SP	6.5"	8.22"	5.0"x5/8"	5J999GBX, 56T105308	8

Fig.1



Fig.2



Fig.3



Fig.4



Fig.5

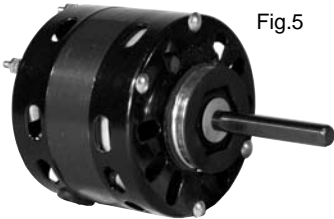

Fig.6



Fig.7



Coldstream Refrigeration

Part #	HP	Spd/RPM	Volts	Amps	Rot	Type	Dia	Body	Shaft	Comment	Fig
R128	1/135	1/1550	115	0.40	CW	SP	3.3"	1.94"	0.6" Hubless	Refrigeration Cases	1
R230	1/70	1/2800	115	0.66	CCW	SP	3.3"	2.16"	1.3" x 1/4"	Refrigeration Cases	2
R122	1/60	1/1550	230	0.35	CW	SP	3.3"	2.19"	0.6" Hubless	Refrigeration Cases	1
R121	1/60	1/1550	230	0.35	CCW	SP	3.3"	2.19"	0.6" Hubless	Refrigeration Cases	1
R137	1/60	1/1550	115	0.55	CW	SP	3.3"	2.19"	0.6" Hubless	Refrigeration Cases	1

Coleman

Part #	HP	Spd/RPM	Volts	Amps	Rot	Type	Dia	Body	Shaft	Comment	Fig
RFB156	1/50	1/3000	115	1.30	CCW	SP	3.3"	6.0"	-	7021-9404	3
RFB391	1/25	1/3000	115	1.10	CCW	SP	3.3"	6.0"	-	7021-5478	4
R2386	1/8	2/1050	115	5.00	CCW	SP	5.0"	3.9"	3.8"x1/2"	Tapped holes for mounting	5
R2645	1/4	2/1625	115	3.10	CW	7.5/370	5.0"	2.2"	5.7"x1/2"x5.7"	322P708	5

Comfort Air

Part #	HP	Spd/RPM	Volts	Amps	Rot	Type	Dia	Body	Shaft	Comment	Fig
R32050	3/4	3/1025	575	1.65	Rev	15/370	5.5"	6.5"	4.0"x1/2"	Commercial Rooftop	6
R32051	3/4	3/1075	460	2.15	Rev	15/370	5.5"	6.6"	4.0"x1/2"	Commercial Rooftop	6

Command Air

Part #	HP	Spd/RPM	Volts	Amps	Rot	Type	Dia	Body	Shaft	Comment	Fig
R42141	1	1/1075	208/230 460	7.60	Rev	PSC/INC	5.5"	8.5"	6.0"x5/8"	G.E.	7

Fig.1



Fig.2



Fig.3

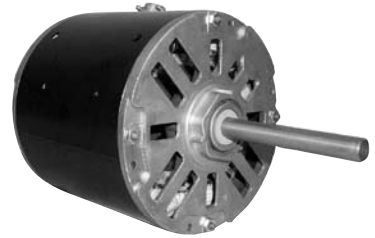

Fig.4



Fig.5



Fig.6

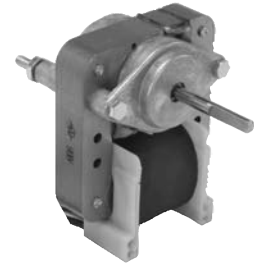

Copeland

Part #	HP	Spd/RPM	Volts	Amps	Rot	Type	Dia	Body	Shaft	Comment	Fig
R5311	6W	1/1550	120	0.36	CW	SP	3.5"	2.8"	HUBLESS	GE5311	1
R5421	9W	1/1550	208/230	0.29	CW	SP	3.5"	2.8"	HUBLESS	GE5421	1
R5411	9W	1/1550	120	0.58	CW	SP	3.5"	2.8"	HUBLESS	GE5411	1
R3512	35W	1/1550	208/230	0.70	CW	SP	3.8"	3.5"	HUBLESS	050-0227-02	2
R3511	35W	1/1550	120	1.40	CW	SP	3.8"	3.5"	HUBLESS	050-0227-01	2
R5012	50W	1/1550	208/230	0.85	CW	SP	3.8"	4.5"	HUBLESS	050-0017-01	1
R5022	50W	1/1550	208/230	0.85	CCW	SP	3.8"	4.5"	HUBLESS	050-0011-00	1
R3047	1/4	1/1625	208/230	1.50	CW	5/370	5.5"	4.30"	2.5" x 1/2"	050-0107-01, 0238-00	3
R3005	1/3	1/825	208/230	2.40	CW	5/370	5.5"	5.00"	3.5" x 1/2"	050-0234-00, 0107-02	3
S1502	1/3	1/1075	200/230 460	1.40	Rev	5/440	5.5"	7.30"	3.5" x 1/2"	050-0015-00, 0105-00	4
T1536	3/4	1/1140	575	1.50	Rev	3 Ph	5.5"	11.00"	4.0" x 5/8"	050-0169-00,01,0236-00	4

Cornelius - QBD

Part #	HP	Spd/RPM	Volts	Amps	Rot	Type	Dia	Body	Shaft	Comment	Fig
R6247	5W	1/1550	115	0.60	CW	SP	3.5"	3.4"	Hubless	Condenser	1
R6243	6W	1/1550	115	0.60	CW	SP	3.5"	3.4"	Hubless	Condenser	1
R6273	9W	1/1550	115	0.58	CW	SP	3.5"	3.1"	Hubless	Condenser	1
R6203	15W	1/1550	115	0.60	CCW	SP	3.9"	3.5"	7.0"x5/16"	Agitator	5
R6204	25W	1/1550	115	1.10	CCW	SP	3.9"	3.5"	5.6"x5/16"	Agitator	5
R6205	25W	1/1550	115	1.10	CCW	SP	3.9"	3.5"	7.0"x5/16"	Agitator	5
R6206	50W	1/1550	115	1.70	CW	SP	3.9"	3.5"	3.0"x5/16"	134350000, ESPOL05OEM B1	5

Fig.1



Fig.2



Fig.3



Fig.4



Fig.5



Fig.6



Fig.7



Fig.8

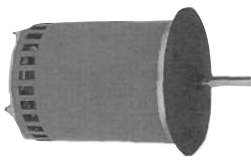

Fig.9



Fig.10



Ducane, Lennox Air Flo

Part #	HP	Spd/RPM	Volts	Amps	Rot	Type	Dia	Body	Shaft	Comment	Fig
RFB936	1/60	1/2800	115	1.10	CCW	SP	3.3"	6.4"	-	MPG50B3, 75B3, B4, 100B4, B5, 125B5, 20093601, 20282002	1
RFB282	1/16	1/3000	115	1.10	CCW	SP	3.3"	7.63"	-	CMPB50U2-50U3, 75U2, 75U3, 20282001	2
RFB540	1/10	1/3450	115	0.70	CCW	PSC/INC	3.3"	6.5"	-	CMPA50U2A, 75U2A, 100U2A, 125U2A, 20054001, 20000101	3

Dundas Foundry

Part #	HP	Spd/RPM	Volts	Amps	Rot	Type	Dia	Body	Shaft	Comment	Fig
RFB500	1/30	1/2860	115	1.10	CCW	SP	3.3"	5.5"	-	Cooler Blower Fan, UE9492	4
RB27	53W	1/2400	115	0.92	CCW	SP	-	-	-	FK26	5

Dunham Bush

Part #	HP	Spd/RPM	Volts	Amps	Rot	Type	Dia	Body	Shaft	Comment	Fig
R124	1/20	1/1550	115	1.60	CCW	SP	3.3"	2.78"	0.90" Hubless	350044, 46, MM2847	6
R125	1/20	1/1550	230	0.75	CCW	SP	3.3"	2.78"	0.90" Hubless	350043, 45, MM2848	6
R42811	1/8	1/1050	115	2.70	CCW	PSC/Inc	5.5"	4.00"	4.8" x 1/2"	350014, 16, E310025	7
S1510	3/4	1/1075	200/230 /460	2.30	Rev	20/370	5.5"	12.20"	3.5" x 1/2"	371027	8
UE-9428	1	1/1100	575	1.60	Rev	3 Ph	6.5"	7.50"	1/2" x 2 3/4"	0371025	9
T1538	1	1/1140	200/230 /460	5.60	Rev	3 Ph	5.5"	11.50"	4.0"x5/8" KF	371026	8
T1540	1	1/1140	575	2.30	Rev	3 Ph	5.5"	11.50"	4.0" x 5/8"	371025, T1538	8
T2158	2	1/1750	208/230 /460	6.00	Rev	3 Ph	6.5"	11.60"	2.3" x 7/8"	390080	10
T2166	2	1/1750	208/230 /460	8.40	Rev	3 Ph	6.5"	12.60"	2.3" x 7/8"	390082,87,88	10

Fig. 1



Fig. 2



Fig. 3



Fig. 4



Fig. 5



Fig. 6



Fig. 7

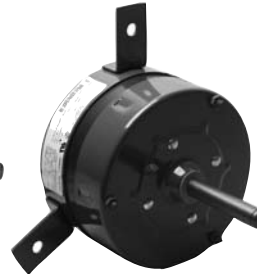
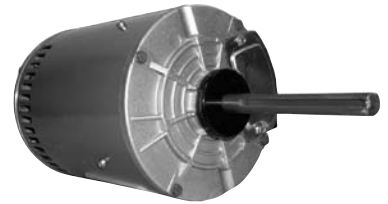

Fig. 8



Duotherm

Part #	HP	Spd/RPM	Volts	Amps	Type	Rot	Dia	Body	Shaft	Comment	Fig
R404	1/50	1/1550	115	0.85	SP	CCW	3.3"	2.84"	1.8"x5/16"	Space Heater	1

E.K.W. (Electrohome - Keeprite - Woods)

Part #	HP	Spd/RPM	Volts	Amps	Rot	Type	Dia	Body	Shaft	Comment	Fig
R506	1/240	1/1400	115	0.43	CW	SP	3.3"	1.90"	2.0"x1/4"	2N8701	2
R503	1/130	1/1550	115	0.40	CW	SP	3.3"	2.09"	2.4"x1/4"	SN4702	2
R325	1/125	1/1550	115	0.33	CCW	SP	3.3"	2.09"	2.3"x1/4"	2N8001	3
R235	1/80	1/1050	115	0.90	CCW	SP	3.3"	2.35"	1.1"x1/4"	W.C. Woods	3
R512	1/75	1/1550	115	0.62	CW	SP	3.3"	2.09"	1.0"x1/4"	2N10201	2
R201	1/50	1/1430	115	0.85	CW	SP	3.3"	2.20"	2.3"x1/4"	Humidifiers	2
R236	1/50	2/1575	115	1.00	CCW	SP	3.3"	2.25"	1.1"x1/4"	27009909, 471628009	4
R510	1/45	3/1550	115	1.10	CW	SP	3.3"	2.25"	1.1"x1/4"x1.5"	W.C. Woods	3
R336	1/25	1/1550	115	1.50	CCW	SP	3.3"	2.60"	1.2"x1/4"	W.C. Woods	5
R717	1/15	3/1550	115	2.00	CCW	SP	3.3"	3.50"	5.0"x5/16"x3.5"	SM717	3
R729	1/15	3/1550	115	2.00	CCW	SP	3.3"	3.50"	3.5"x5/16"x5.0"	SM704	6
R731	1/15	2/1550	115	2.35	CCW	SP	4.1"	3.10"	2.3"x3/8"x2.3"	SM703	7
R736	1/12	3/1080	115	3.50	CCW	4/370	5.0"	3.50"	1.9"x1/2"x2.7"	SM701, 715, 706, 716, 721	7
R780	1/8	3/1330	115	1.70	CCW	10/370	5.0"	3.50"	2.4"x1/2"x5.0"	89395, 200423, SM713	7
T2538	1	1/1140	208/230 460	4.20	Rev	3 PH	6.5"	9.10"	5.0"x5/8"	170518, 502595	8
T2540	1	1/1140	575	1.20	Rev	3 PH	6.5"	9.10"	5.0"x5/8"	170517, KPN502597	8

Rotation determined opposite shaft end
Double shaft determined at lead end

Shaft length measured from
hub face to shaft end

Fig. 1



Fig. 2



Fig. 3



Fig. 4



Fig. 5



Fig. 6



Fig. 7



Elmira Woodstoves

Part #	HP	Spd/RPM	Volts	Amps	Rot	Dia	Body	Shaft	Comment	Fig
RB200T-2	35W	2/1600	115	0.80	CCW	3.3"	3.5"	-	200 CFM Blower	1
R489	1/60	3/1300	115	0.92	CW	3.3"	2.5"	3.6"x5/16"x3.5	1500, 1600	2
RB34	1/55	1/3200	115	0.88	CW	3.3"	6.6"	-	Gen. Replacement	3

Emerson

Part #	HP	Spd/RPM	Volts	Amps	Rot	Type	Dia	Body	Shaft	Comment	Fig
R506	1/240	1/1400	115	0.43	CW	SP	3.3"	1.90"	2.0"x1/4"	VENT FAN	4
R209	1/45	1/1550	115	0.87	CW	SP	3.3"	2.30"	1.5"x5/16"	VENT FAN	4
R742	1/10	3/1080	115	1.40	CCW	4/370	5.0"	3.30"	2.2"x1/2"x2.6"	QUIET COOL A/C	5
R743	1/5	3/1400	208/230	1.60	CCW	5/370	5.0"	3.90"	2.5"x1/2"x3.5"	QUIET COOL A/C	5
R2630	1/3	2/1400	208/230	2.40	CW	6/370	5.0"	4.10"	5.0"x1/2"	F1611, QUIET COOL	6

F.P.E. (Federal Pioneer - Westcan)

Part #	HP	Spd/RPM	Volts	Amps	Rot	Type	Dia	Body	Shaft	Comment	Fig
R302	1/100	1/1550	230	0.20	CW	SP	3.3"	2.25"	2.0"x1/4"	L81512W1	7
R511	1/100	1/1350	230	0.28	CW	SP	3.3"	2.10"	2.0"x1/4"	Electric Heaters	7
R217	1/35	1/1450	230	0.50	CW	SP	3.3"	2.40"	1.2"x1/4"	L82116A4	7

Fig. 1

Fig. 2

Fig. 3

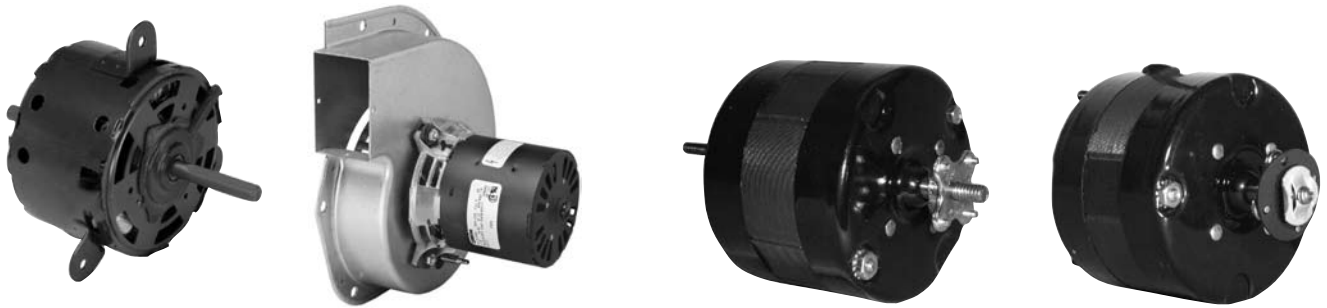

Fig. 4

Fig. 5

Fig. 6

Fig. 7



Fedders

Part #	HP	Spd/RPM	Volts	Amps	Rot	Type	Dia	Body	Shaft	Comment	Fig
R740	1/6	2/1050	208/230	2.20	CCW	SP	5.0"	3.00"	2.3"x1/2"x4.0"	S196-00161-003, 016	1
R52126	1/6	3/1075	115	2.20	CCW	5/370	5.5"	3.80"	7.5"x1/2"x8.1"	R.A.C.	2
R22180	1/5	1/1080	208/230	1.30	CW	PSC/INC	5.5"	3.70"	4.3"x1/2"	S196-179-1, 66-1	3
R881	1/4	3/1075	208/230	2.20	CCW	5/370	5.5"	3.90"	2.5"x1/2"x4.5"	S196-58-2	1
R52113	1/4	3/1075	208/230	1.90	CCW	5/370	5.5"	4.00"	7.5"x1/2"x8.0"	R.A.C.	2
R52288	1/2	3/1075	208/230	3.80	CW	5/370	5.5"	4.80"	4.0"x1/2"x3.0"	S196-170-6	4

Flame Master

Part #	HP	Spd/RPM	Volts	Amps	Rot	Type	Dia	Body	Shaft	Comment	Fig
RFB111	1/25	1/3000	120	1.2	CCW	SP	3.3"	6.0"	-		5

Foster Refrigeration

Part #	HP	Spd/RPM	Volts	Amps	Rot	Type	Dia	Body	Shaft	Comment	Fig
R120	1/85	1/1550	115	0.45	CW	SP	3.3"	2.19"	0.6" Hubless	Refrigeration Cases	6
R119	1/85	1/1550	115	0.45	CCW	SP	3.3"	2.19"	0.6" Hubless	Refrigeration Cases	6
R127	1/75	1/1550	115	0.75	CCW	SP	3.3"	1.94"	1.0" Hubless	Refrigeration Cases	6
R122	1/60	1/1550	230	0.35	CW	SP	3.3"	2.19"	0.6" Hubless	Refrigeration Cases	6
R121	1/60	1/1550	230	0.35	CCW	SP	3.3"	2.19"	0.6" Hubless	Refrigeration Cases	6
R101	1/45	1/1550	115	0.90	CW	SP	3.3"	2.19"	0.7" Hubless	Refrigeration Cases	7
R103	1/45	1/1550	115	0.90	CCW	SP	3.3"	2.19"	0.7" Hubless	Refrigeration Cases	7

Rotation determined opposite shaft end
Double shaft determined at lead end

Shaft length measured from
hub face to shaft end

Fig.1

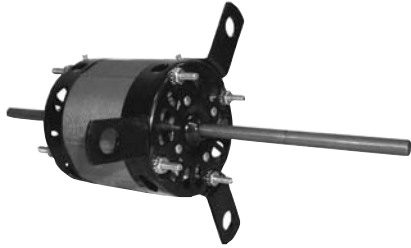

Fig.2



Fig.3



Fig.4



Fig.5



Fig.6



Friedrich

Part #	HP	Spd/RPM	Volts	Amps	Rot	Type	Dia	Body	Shaft	Comment	Fig
R52639	1/6	5/1075	208/230	0.80	CCW	4/370	5.5"	4.00"	2.5"x1/2"x3.7"	R.A.C.	1

Frigidaire

Part #	Watts	Spd/RPM	Volts	Amps	Rot	Type	Dia	Body	Shaft	Comment	Fig
R4110	23	1/1550	115	0.80	CW	SP	3.9"	4.00"	2.5"x5/16"	Agitator	2

Goodman-Janitrol

Part #	HP	Spd/RPM	Volts	Amps	Rot	Type	Dia	Body	Shaft	Comment	Fig
RFB162		1/3000	208/230	0.50	CW	SP	3.3"	8.5"	-	82959000	3
RFB140		1/3450	115	1.40	CCW	SP	3.3"	5.6"	-	B28330-01	4
RFB185		1/3000	115	1.30	CW	SP	Skel	5.80"	-	B1859005, Gaskets Included	5
RFB590	1/30	1/3000	115	1.40	CW	SP	Skel	5.44"	-	B40590-00	5
RFB595	1/30	1/3000	115	1.40	CW	SP	Skel	5.89"	-	B18590-05	5
RFB276	1/30	1/3000	115	1.40	CW	SP	Skel	5.44"	-	0131M00002P	5
RFB501	1/20	1/3000	115	2.80	CW	SP	Skel	5.57"	-	22307501	6



Fig.1

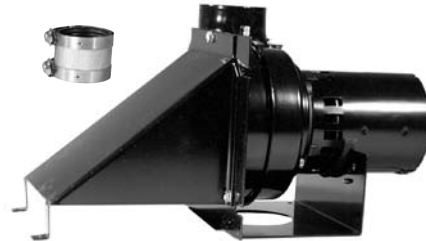

Fig.2



Fig.3



Fig.4



Fig.5



Fig.6

Grimsby

Part #	HP	Spd/RPM	Volts	Amps	Type	Rot	Dia	Body	Shaft	Comment	Fig
RFB111	1/25	1/3000	115	1.20	SP	CCW	3.3"	6.0"	-	SBC375, CPL1132	1

G.S.W.

Part #	HP	Spd/RPM	Volts	Amps	Type	Rot	Dia	Body	Shaft	Comment	Fig
RFB127	1/20	1/3200	115	1.30	SP	CCW	3.3"	12.5"	-	63172, 63418	2
RFB172	1/20	1/3200	115	1.30	SP	CCW	3.3"	12.5"	-	63172, 63418, 7021-8247	3

Habco (H.A. Brown)

Part #	HP	Spd/RPM	Volts	Amps	Type	Rot	Dia	Body	Shaft	Comment	Fig
R606	1/130	1/3000	115	0.50	SP	CCW	Skel	0.65"	1.0"x7/32"	CO21795	4
R607	1/50	1/2300	115	1.30	SP	CCW	Skel	1.16"	1.75"x7.32"	CO21617	4

Hartell

Part #	HP	Spd/RPM	Volts	Amps	Type	Rot	Dia	Body	Shaft	Comment	Fig
R4110	23 W	1/1550	115	0.80	SP	CW	3.9"	4.00"	2.5"x5/16"	Agitator	5

Hearth & Home Technologies

Part #	HP	Spd/RPM	Volts	Amps	Type	Rot	Dia	Body	Shaft	Comment	Fig
RB81	81 W	1/2400	115	0.92	SP			12.8"x4.5"x4.3"	-	FKGAS	6

Rotation determined opposite shaft end
Double shaft determined at lead end

Shaft length measured from
hub face to shaft end

Fig.1



Fig.2



Fig.3



Fig.4



Fig.5



Fig.6

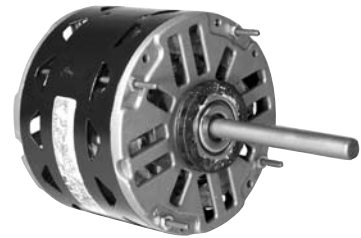

Heat-N-Glow

Part #	CFM	Spd/RPM	Volts	Amps	Type	Rot	Dia	Body	Shaft	Comment	Fig
RB168	168	1/2900	115	1.10	SP	CW	Skel	12.75"	-	7002-1241,GFK160A	1

Heatilator

Part #	Watts	Spd/RPM	Volts	Amps	Type	Rot	Dia	Body	Shaft	Comment	Fig
RB21K	35	1/1800	115	0.75	SP	CCW	Skel	8.0"x4.3"x3.6"	-	FK21,GFK21	2
RB74K	50	1/1250	115	0.86	SP	CW	Skel	12.9"x4.3"x3.6"	-	FK4, GFK4	3

Heritage Energy Fireplaces

Part #	HP	Spd/RPM	Volts	Amps	Type	Rot	Dia	Body	Shaft	Comment	Fig
RB33	1/65	1/3200	115	0.70	SP	CW	3.3"	6.6"	-	2040001	4
RB60	1/50	1/3200	115	1.00	SP	CW	3.3"	5.5"	-	2810-005-052, EM60, IC18	5

Heil - Quaker

Part #	HP	Spd/RPM	Volts	Amps	Type	Rot	Dia	Body	Shaft	Comment	Fig
R42800	1/2	4/1050	115	11.00	SP	R.P.	5.5"	5.80"	5.5"x5/8"	Furnace/ Evaporator	6



Hill

Part #	HP	Spd/RPM	Volts	Amps	Rot	Type	Dia	Body	Shaft	Comment	Fig
R5911	6W	1/1550	115	0.40	CW	SP	3.5"	3.40"	-	PP7577M	1
R5411	9W	1/1550	115	0.58	CW	SP	3.5"	2.80"	-	GE5411	1
R5711	15W	1/1550	115	0.37	CW	PSC	3.5"	3.50"	-	P41661	2
R5720	15W	1/1550	115	0.37	Rev	PSC	3.5"	3.50"	-	P23956	2
R2011	20W	1/1550	115	0.80	CW	SP	3.5"	3.75"	-	PP20934F	2
R129	1/55	1/3000	115	0.70	CCW	SP	3.3"	2.41"	0.5" Hubless	PP32032E	3
R3001	1/3	1/1625	208/230	1.80	CW	PSC/INC	5.5"	4.50"	3.5"x1/2"	PP3955B	4
R3067	1	1/1075	208/230	7.10	Rev	PSC/15/370	5.5"	9.20"	3.8"x1/2"	PP19162G	4

Honeywell

Part #	HP	Spd/RPM	Volts	Amps	Type	Rot	Dia	Body	Shaft	Comment	Fig
R2654	1/12	3/1075	115	3.10	SP	CW	5.0"	2.7"	3.9"x1/2"	190386A	5

Hunter

Part #	HP	Spd/RPM	Volts	Amps	Type	Rot	Dia	Body	Shaft	Comment	Fig
RB48	-	1/2700	115	0.19	SP	CCW	-	4 3/4"x4 3/4"x1 5/8"	-	921482	6
RB79	62W	1/1200	115	1.10	SP	CCW	Skel	15.7"x4.3"x3.6"	-	F125H, HWF30, HDV30	7
RB68	50W	1/1250	115	0.86	SP	CW	Skel	12.9"x4.3" x3.6"	-	770, HDS2000, HDS3000, HF130, HDV31, MGDV31, SFDV20	8
RB91	1/250	1/1500	115	0.30	SP	CCW	3.3"	5.5"	-	912754	9
RB735	1/125	1/1500	115	0.36	SP	CCW	3.3"	5.7"	-	7036-7735	11
R325	1/125	1/1500	115	0.40	SP	CCW	3.3"	2.06"	2.3"x1/4"	2SR	10
R108	1/95	1/1550	115	0.55	SP	CCW	3.3"	2.0"	Hubless	124574	12

Rotation determined opposite shaft end
Double shaft determined at lead end

Shaft length measured from
hub face to shaft end

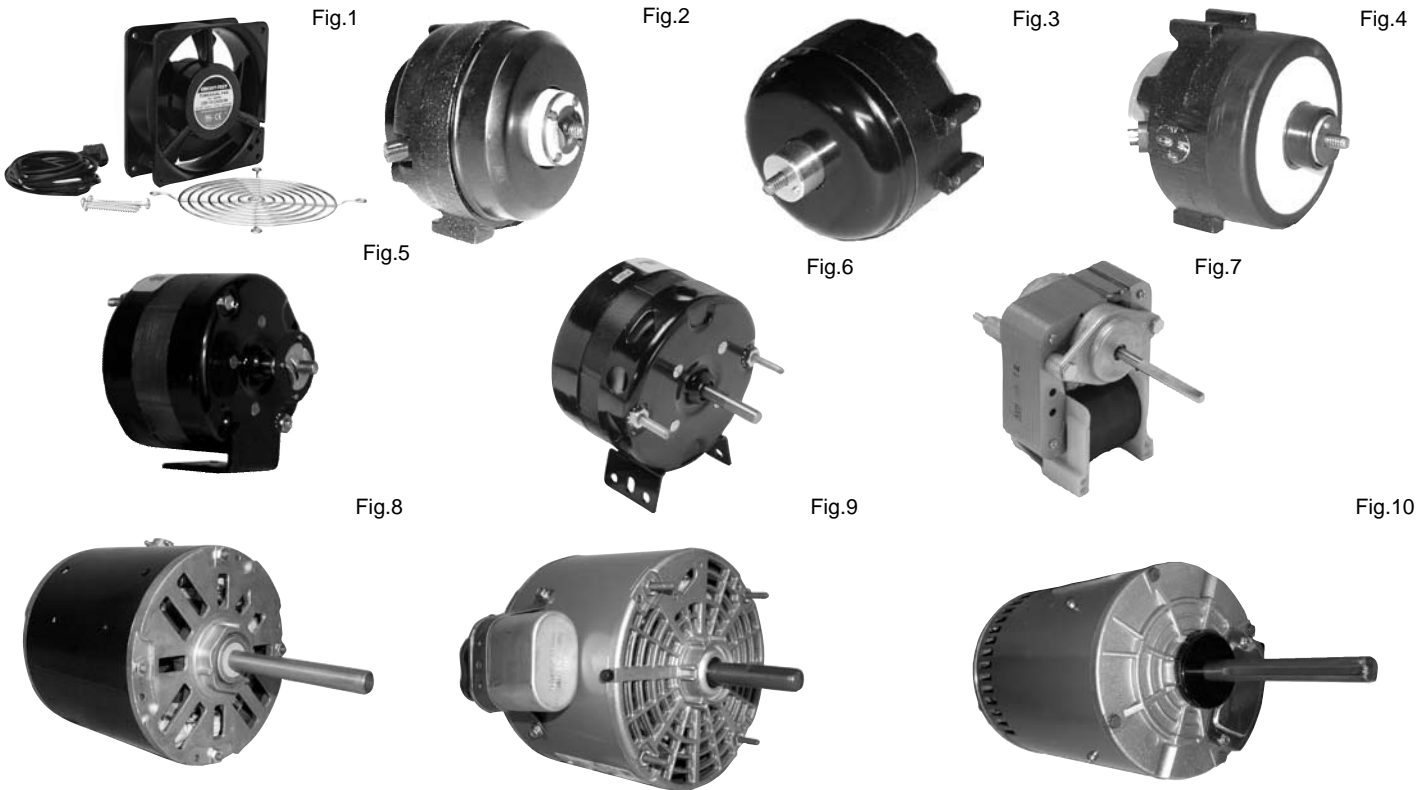

Hussmann

Part #	HP	Spd/RPM	Volts	Amps	Rot	Type	Body	Dia	Shaft	Comment	Fig
RF2466	105 CFM	1/3000	115 VAC	0.14	-	SP	-	Axial	-	HUSSMANN 392466, R2466 44db (A) Terminal Connection	1
EE-5610	6	1/1550	115	0.40	CW	SP	3.30"	3.5"	Hubless	38360	2
EE-5611	9	1/1550	115	0.52	CW	SP	3.30"	3.5"	Hubless	4700, 58698	2
R5611	9	1/1550	115	0.66	CW	SP	3.10"	3.5"	Hubless	4700, 58698	3
R5612	9	1/1550	115	0.66	CCW	SP	3.10"	3.5"	Hubless	38360	3
R101L	9	1/1550	115	0.90	CW	SP	2.36"	3.3"	0.7" Hubless	Available w/o leg (R101)	5
R103L	9	1/1550	115	0.90	CCW	SP	2.36"	3.3"	0.7" Hubless	Available w/o leg (R103)	5
R5720	15	1/1550	115	0.37	Rev.	SP	3.50"	3.5"	Hubless	302555, 254582, 411151	4
R5711	15	1/1550	115	0.37	CW	SP	3.50"	3.5"	Hubless	301263, 301264, 329646, 400603	4
R326	1/110	1/1550	115	0.40	CW	SP	2.09"	3.3"	1.4"x1/4"	Evap. Motor	6
R605	1/55	1/2800	115	0.90	CW	SP	0.90"	Skel	1.7"x.181"	P211116966a	7
R130	1/25	1/1550	230	0.80	CW	SP	2.72"	3.3"	1.5"x5/16"	Evap. Motor	6
R318	1/25	1/1550	115	1.50	CW	SP	2.80"	3.3"	2.8"x5/16"	Evap. Motor	6
R3006	1/6	1/1075	208/230	1.20	CW	PSC/INC	4.20"	5.5"	1.5"x1/2"	GE3006	8
R30575	1/6	1/1550	575	0.50	Rev	PSC/INC	4.50"	5.5"	2.2"x1/2"	77228, 77238	9
R34201	1/5	1/1075	575	0.50	CW	PSC/INC	4.50"	5.5"	2.5"x1/2"	204201	9
T2538	1	1/1140	208/230 460	4.10	Rev	3 Ph	8.22"	6.5"	5.0"x5/8"	170518, 502595	10
T2540	1	1/1140	575	1.70	Rev	3 Ph	9.10"	6.5"	5.0"x5/8"	170517, KPN502597	10



ICP

Part #	HP	Spd/RPM	Volts	Amps	Rot	Type	Dia	Body	Shaft	Comment	Fig
RFM504	1/200	1/3000	208/230	0.25	CCW	SP	Skel	4.90"	0.8"x1/4"	50415K, 504015K	1
RFB141	1/65	1/2800	115	1.00	CCW	SP	3.3"	6.00"	-	1094073-74, 10100239	2
RFB105	1/50	1/3200	230	0.40	CW	SP	3.3"	2.75"	-	HQ1050144, 1170870	3
RFB68	1/50	1/3000	115	0.90	CW	SP	3.3"	5.25"	-	1006168, c/w gaskets	4
RFB107	1/40	2/3350	208/230	0.30	CW	3/370	3.3"	8.70"	-	1097245 c/w gaskets	5
RFB433	1/35	1/3000	115	1.50	CW	SP	Skel	6.00"	-	1014433, 1014529	6
RFB833	1/30	1/3000	115	1.60	CCW	SP	Skel	6.50"	-	1013833	2
R2609	1/30	1/1550	115	1.21	CW	SP	4.1"	3.00"	2.4"x1/2"	UE009	7
R2612	1/30	1/1550	115	1.21	CCW	SP	4.1"	3.00"	2.4"x1/2"	UE2612	7
RFB145	1/25	1/3450	115	0.70	CW	PSC/INC	3.3"	5.30"	-	1009924, 1009518, 1010527, 1011404, c/w gaskets & coupling	8
RFB134	1/25	1/3000	115	1.50	CCW	SP	3.3"	6.00"	-	1010324, 1708607, 1010975	2
RFB350	1/25	1/3450	115	0.80	CW	5/370	3.3"	7.10"	-	1011350	9
RFB330	1/20	1/3000	115	2.40	CCW	SP	Skel	5.54"	-	330701-701, 329148-701, 1013915	8
R784	1/20	3/1060	208/230	0.40	Rev	4/370	5.5"	3.50"	2.3"x1/2"	130784	10
RFM232	1/16	1/3450	208/230	0.55	CW	PSC/INC	3.3"	5.00"	2.8"x5/16"	1171348, JF1H092N	11
RFM462	1/16	1/3450	460	0.30	CW	PSC/INC	3.3"	4.75"	3.3"x5/16"	1171347	11
RFM9	1/12	1/3000	208/230	1.10	CCW	SP	3.3"	6.40"	2.8"x5/16"	501493	12
RFB9	1/12	1/3000	208/230	1.10	CCW	SP	3.3"	10.00"	-	501493	13
R22576	1/9	2/1060	208/230	0.60	CW	3/370	5.5"	3.80"	2.3"x1/2"	128576	10

Rotation determined opposite shaft end
Double shaft determined at lead end

Shaft length measured from
hub face to shaft end

Fig.1



Fig.2



Fig.3



Fig.4



Fig.5



Fig.6



Ideal

Part #	HP	Spd/RPM	Volts	Amps	Rot	Type	Dia	Body	Shaft	Comment	Fig
R611	1/300	1/1550	115	0.54	CW	SP	Skel	0.50"	2.2"x.181"	Evaporator Motor	1
R108	1/100	1/1550	115	0.55	CCW	SP	3.3"	1.94"	0.7" HUBLESS	Evaporator Motor	2
R123	1/50	1/1550	115	0.60	CW	SP	3.3"	2.44"	0.6" HUBLESS	Evaporator Motor	2
R126	1/50	1/1550	115	0.75	CW	SP	3.3"	2.44"	0.8" HUBLESS	Evaporator Motor	3

Intercity

Part #	HP	Spd/RPM	Volts	Amps	Rot	Type	Dia	Body	Shaft	Comment	Fig
R2609	1/30	1/1550	115	1.21	CW	SP	4.1"	3.00"	2.4"x1/2"	UE009	4
R2612	1/30	1/1550	115	1.21	CCW	SP	4.1"	3.00"	2.4"x1/2"	UE2612	4

Jennair

Part #	HP	Spd/RPM	Volts	Amps	Rot	Type	Dia	Body	Shaft	Comment	Fig
RFB500	1/30	1/2860	115	1.10	CCW	SP	3.3"	5.50"	-	FASCO D500	6

Johnson, Airease, Magic Chef Furnace

Part #	HP	Spd/RPM	Volts	Amps	Rot	Type	Dia	Body	Shaft	Comment	Fig
RFB6	1/60	1/3000	230	0.55	CW	SP	3.3"	6.10"	-	3855C1, 3855C3, 8973C1, 80280	5

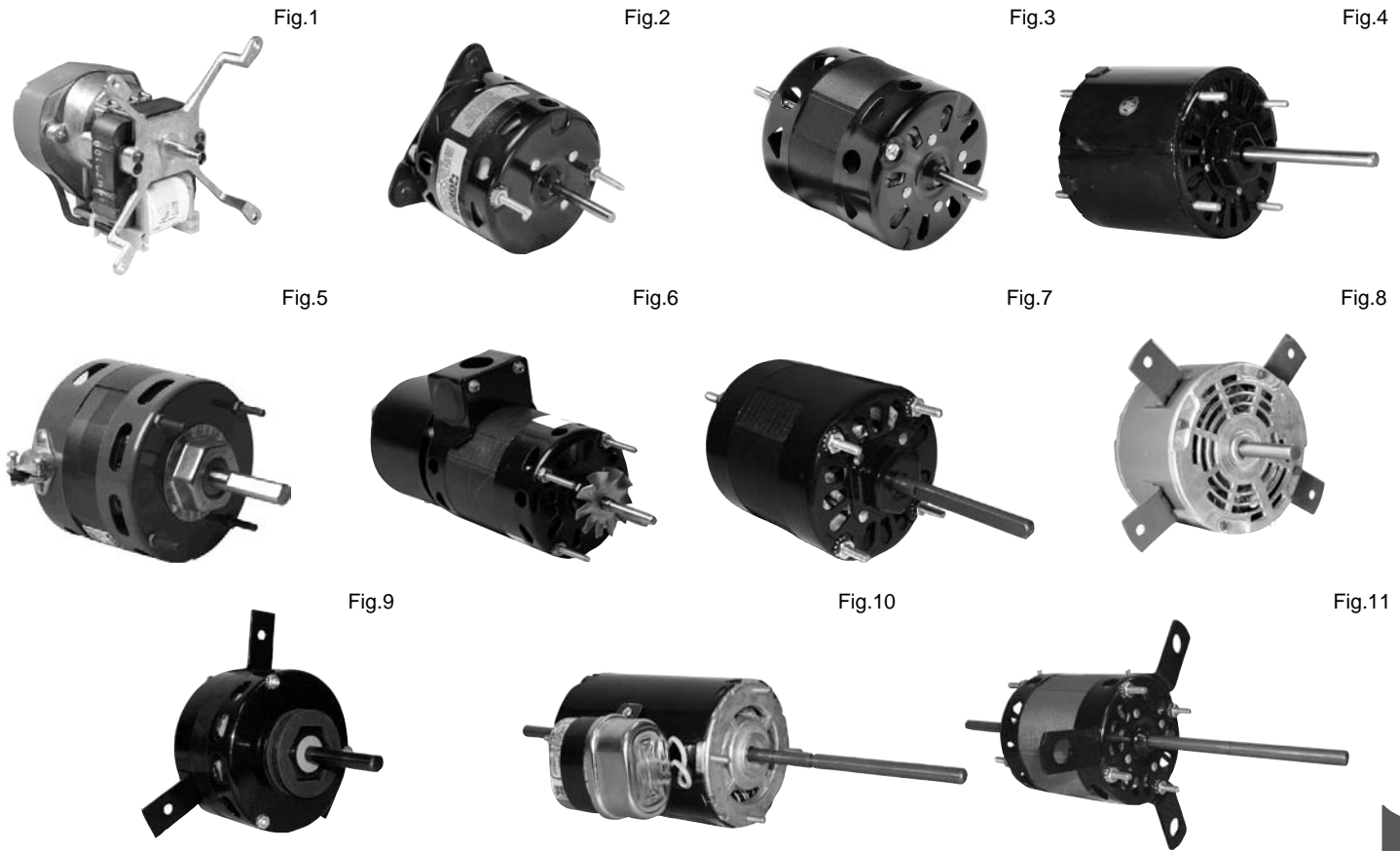

Keeprite (ICP) - continued next page

Part #	HP	Spd/RPM	Volts	Amps	Rot	Type	Dia	Body	Shaft	Comment	Fig
RFM504	1/200	1/3000	208/230	0.25	CCW	SP	Skel	4.90"	0.8"x1/4"	50415K, 504015K	1
R205	1/35	1/1550	115	1.20	CW	SP	3.3"	2.50"	1.8"x1/4"	11796-8	2
R307	1/30	1/3000	115	1.10	CCW	SP	3.3"	3.30"	1.3"x1/4"	85680	3
R2811	1/20	1/1050	115	2.10	CCW	SP	4.1"	2.60"	2.5"x1/2"	28110	3
R1052	1/20	1/1550	115	2.00	CCW	SP	3.3"	3.00"	3.2"x5/16"	1043336	4
R1053	1/20	1/1550	230	1.00	CCW	SP	3.3"	3.00"	3.2"x5/16"	1043766	4
R2817	1/20	1/1550	115	1.60	CCW	SP	4.1"	3.10"	2.8"x1/2"	28175	5
RFM653	1/20	1/3450	230/460	0.40	CW	SP	3.3"	6.30"	2.3"x1/4"	U653	6
R370	1/20	1/1550	115	0.77	CCW	PSC/INC	3.3"	4.09"	2.5"x5/16"	501899,501898, FASCO 7164-1243	7
R371	1/20	1/1550	230	0.36	CW	SP	3.3"	4.09"	2.6"x5/16"	501909	7
R784	1/20	3/1060	208/230	0.40	Rev	4/370	5.5"	3.50"	2.3"x1/2"	130784	8
R2657	1/15	1/1550	230	1.20	CW	SP	4.1"	3.40"	1.8"x3/8"	81335	5
R2658	1/15	1/1550	115	2.30	CW	SP	4.1"	3.40"	1.8"x3/8"	81356	5
R2269	1/15	1/1050	115	2.40	CCW	SP	5.0"	3.00"	3.0"x1/2"	160269	9
R717	1/15	3/1550	115	2.00	CCW	SP	3.3"	3.50"	5.0"x5/16"x3.5"	125039, SM717	10
R729	1/15	3/1550	115	2.00	CCW	SP	3.3"	3.50"	3.5"x5/16"x5.0"	123652, SM704	11
R731	1/15	2/1550	115	2.35	CCW	SP	4.1"	3.10"	2.3"x3/8"x2.3"	122958, 123655, 170621, 71108, 90013, 90248, 96962, SM703	9
R736	1/12	3/1080	115	1.30	CCW	4/370	5.0"	3.50"	1.9"x1/2"x2.7"	130184, SM701, SM715, SM706, SM716, SM721	9

Fig.1

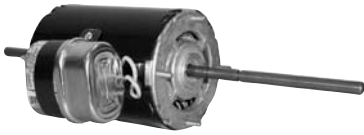

Fig.2



Fig.3



Fig.4

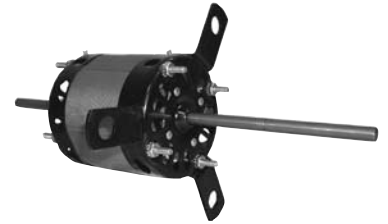

Fig.5



Fig.6

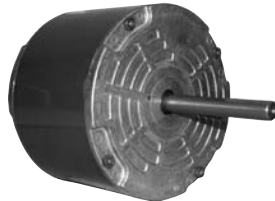

Fig.7



Fig.8



Fig.9



Keeprite (ICP) - continued from previous

Part #	HP	Spd/RPM	Volts	Amps	Rot	Type	Dia	Body	Shaft	Comment	Fig
R701	1/12	1/1550	115	1.30	CCW	PSC/INC	3.3"	4.60"	5.0"x5/16"x2.7"	202807, SM720	1
RFM9	1/12	1/3000	208/230	1.10	CCW	SP	3.3"	6.40"	2.8"x5/16"	501493	2
R22576	1/9	2/1060	208/230	0.60	CW	3/370	5.5"	3.80"	2.3"x1/2"	128576	3
R2423	1/8	3/1330	115	1.80	CW	10/370	5.0"	3.40"	5.0"x1/2"x2.0"	200423, R780	3
R780	1/8	3/1330	115	1.70	CW	10/370	5.5"	3.50"	2.4"x1/2"x5.1"	200423, 71213, 71924, 71925, 88425, 88898, 89395, SM711	4
R785	1/6	1/1060	208/230	0.90	CW	3/370	5.5"	3.30"	2.3"x1/2"	128577	3
R30575	1/6	1/1625	575	0.50	Rev	PSC/INC	5.5"	4.50"	2.2"x1/2"	1042401	5
R31672	1/6	2/1075	208/230	1.50	CW	7.5/370	5.5"	4.00"	3.5"x1/2"	171672, 120240	6
R30409	1/5	1/1550	208/230	1.80	CCW	4/370	5.5"	4.60"	3.0"x1/2"	120409, 1041300	7
R31065	1/5	1/1140	575	0.50	Rev	3 Ph	5.5"	6.30"	2.8"x5/8"	171065	6
R30900	1/2	1/1075	208/230	2.30	CW	7.5/370	5.5"	5.25"	4.0"x5/8"	510900	7
T1536	3/4	1/1140	575	1.50	Rev	3 Ph	5.5"	11.00"	4.0"x5/8"	106670	8
R42464	1	3/1075	208/230 460	5.40	R.P.	12.5/370	5.5"	6.50"	3.5"x5/8"	504464	7
T2538	1	3/1140	208/230 460	4.00	Rev	3 Ph	6.5"	9.10"	5.0"x5/8"	170518, 502595	7
T2540	1	1/1140	575	2.30	Rev	3 Ph	6.5"	9.10"	5.0"x5/8"	170517, KPN502597	7
T1826	1¼	1/1100	208/230	5.00	Rev	3 Ph	6.5"	9.50"	3.0"x5/8"	1043297-001	9
T1946	1¼	1/1100	575	2.00	Rev	3 Ph	6.5"	9.50"	3.0"x5/8"	1043299-001	9
S1454	1¾	1/1075	208/230	5.50	Rev	20/370	6.5"	10.50"	6.0"x5/8"	170619	7



Fig.2



Fig.3



Fig.4



Fig.5

Kemac

Part #	HP	Spd/RPM	Volts	Amps	Type	Rot	Dia	Body	Shaft	Comment	Fig
R410	1/130	1/1550	115	0.35	SP	CW	3.3"	2.75"	2.0"x5/16"	Space Heater	1

Kingsman

Part #	Watts	Spd/RPM	Volts	Amps	Type	Rot	Dia	Body	Shaft	Comment	Fig
RB37	42	1/1400	115	0.75	SP	CCW	Skel	10.5"x4.3"x3.6"	-	Z33FK, ZDV3320, ZDV6000	2
RB35	50	1/1250	115	0.86	SP	CW	Skel	12.9"x4.3"x3.6"	-	F35K, FDV350, FDV5000, 4000	3
RB36	50	1/1250	115	0.86	SP	CW	Skel	12.9"x4.3"x3.6"	-	Z36FK, ZDV3600, ZDV4200N	4

Kysor

Part #	Watt	Spd/RPM	Volts	Amps	Rot	Type	Dia	Body	Shaft	Comment	Fig
R5711	15	1/1550	115	0.37	CW	SP	3.5"	3.50"	-	09A10-054, 09A10-055	5
R5715	15	1/1550	115	0.37	CW	SP	3.5"	3.50"	-	73049	5
R5720	15	1/1550	115	0.37	Rev	SP	3.5"	3.50"	-	09A10-056	5

Rotation determined opposite shaft end
Double shaft determined at lead end

Shaft length measured from
hub face to shaft end

Fig.1



Fig.2



Fig.3



Fig.4



Fig.5



Larkin

Part #	HP	Spd/RPM	Volts	Amps	Rot	Type	Dia	Body	Shaft	Comment	Fig
R394	1/20	1/1550	115	1.60	CCW	SP	3.3"	2.75"	2.5"x5/16"	253-1194	1
R395	1/20	1/1550	208/230	0.81	CCW	SP	3.3"	2.75"	2.5"x5/16"	253-1195	1

Lau

Part #	HP	Spd/RPM	Volts	Amps	Rot	Type	Dia	Body	Shaft	Comment	Fig
R207	1/70	1/1550	115	0.80	CW	SP	3.3"	2.00"	1.4"x1/4"	Range Hood	2
R408	1/65	2/1550	115	0.72	CCW	SP	3.3"	2.25"	1.6"x1/4"x1.6"	421306-01	3

Lear

Part #	HP	Spd/RPM	Volts	Amps	Rot	Type	Dia	Body	Shaft	Comment	Fig
R108	1/95	1/1550	115	0.55	CCW	SP	3.3"	2.00"	-	Furnace	4

Leigh

Part #	HP	Spd/RPM	Volts	Amps	Rot	Type	Dia	Body	Shaft	Comment	Fig
R203	1/70	1/1550	115	0.80	CCW	SP	3.3"	2.10"	1.5"x1/4"	59711	5
R220	1/20	1/1550	115	1.60	CCW	SP	3.3"	2.80"	1.2"x5/16"	16603, 97721	5

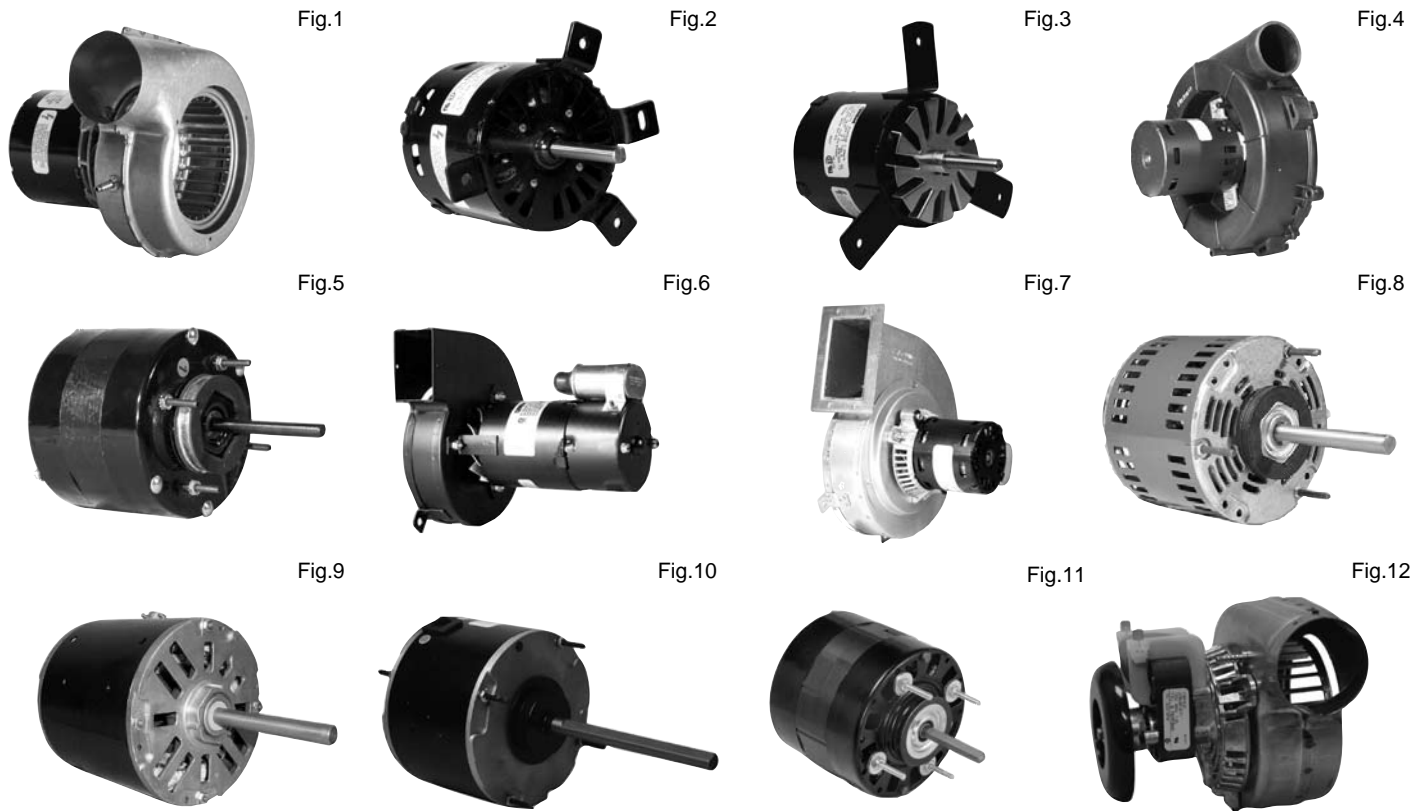

Lennox

Part #	HP	Spd/RPM	Volts	Amps	Rot	Type	Dia	Body	Shaft	Comment	Fig
RFB135	1/65	1/3000	115	0.70	CW	SP	3.3"	5.50"	-	19J04	1
RFB138	1/60	1/3000	115	0.70	CCW	SP	3.3"	-	-	702186578	1
RFB840	1/50	1/3000	115	1.30	CW	SP	Skel	5.83"	-	88K8401, 85L49	12
RFB164	1/50	1/3000	115	0.80	CW	SP	3.3"	5.80"	-	46K4101	1
RFB43	1/50	1/3000	115	0.80	CW	SP	3.3"	5.80"	-	43K41	1
RFM1198	1/30	1/3200	115	1.50	CCW	SP	3.3"	3.40"	2.2"x5/16"	25J1201	2
RFM890	1/25	1/3200	208/230	0.70	CCW	SP	3.3"	3.29"	2.3"x5/16"	98G8901	3
RFB547	1/20	1/3400	115	1.80	CW	SP	3.3"	5.80"	-	68K21, c/w gaskets	4
R6920	1/15	1/1050	115	3.40	CCW	SP	5.0"	3.90"	3.0"x3/8"	P-8-6920	5
RFB101	1/12	1/3200	208/230	0.50	CCW	PSC/INC	3.3"	8.25"	-	23G8101, 135372, 074, 28G6601	6
RFB701	1/10	1/3200	208/230	0.60	CCW	PSC/INC	3.3"	6.75"	-	98G8701	7
R2368	1/8	4/1030	115	3.50	CCW	4/370	5.0"	4.50"	3.5"x1/2"	P9662	8
R22648	1/6	2/825	208/230	0.90	R.P.	5/370	5.5"	4.50"	6.5"x1/2"	HS16 UNITS	9
R22184	1/6	1/1075	208/230	1.30	Rev	3/370	5.5"	3.80"	6.0"x1/2"	47F9901, 48A11T300	10
R42281	1/4	1/1075	230	2.20	CCW	4/370	5.5"	4.50"	2.5"x1/2"	D814,P-8-2072,S3004, 5KCP39GG124S	11
R42441	1/4	1/1050	208/230	2.50	CCW	PSC/INC	5.5"	4.30"	3.9"x1/2"	Condenser Fan	11
R22474	1/4	2/825	208/230	1.50	R.P.	7.5/370	5.5"	5.10"	6.5"x1/2"	Consender Fan	9
R22442	1/4	2/1075	208/230	1.30	R.P.	5/370	5.5"	4.30"	6.0"x1/2"	Condenser Fan	10
R22432	1/4	2/1075	208/230	1.40	R.P.	5/370	5.5"	4.30"	6.5"x1/2"	Condenser Fan	9
R2390	1/4	3/1075	115	3.80	CW	15/370	5.0"	3.80"	3.5"x1/2"	P-8-9662	11

Rotation determined opposite shaft end
Double shaft determined at lead end

Shaft length measured from
hub face to shaft end

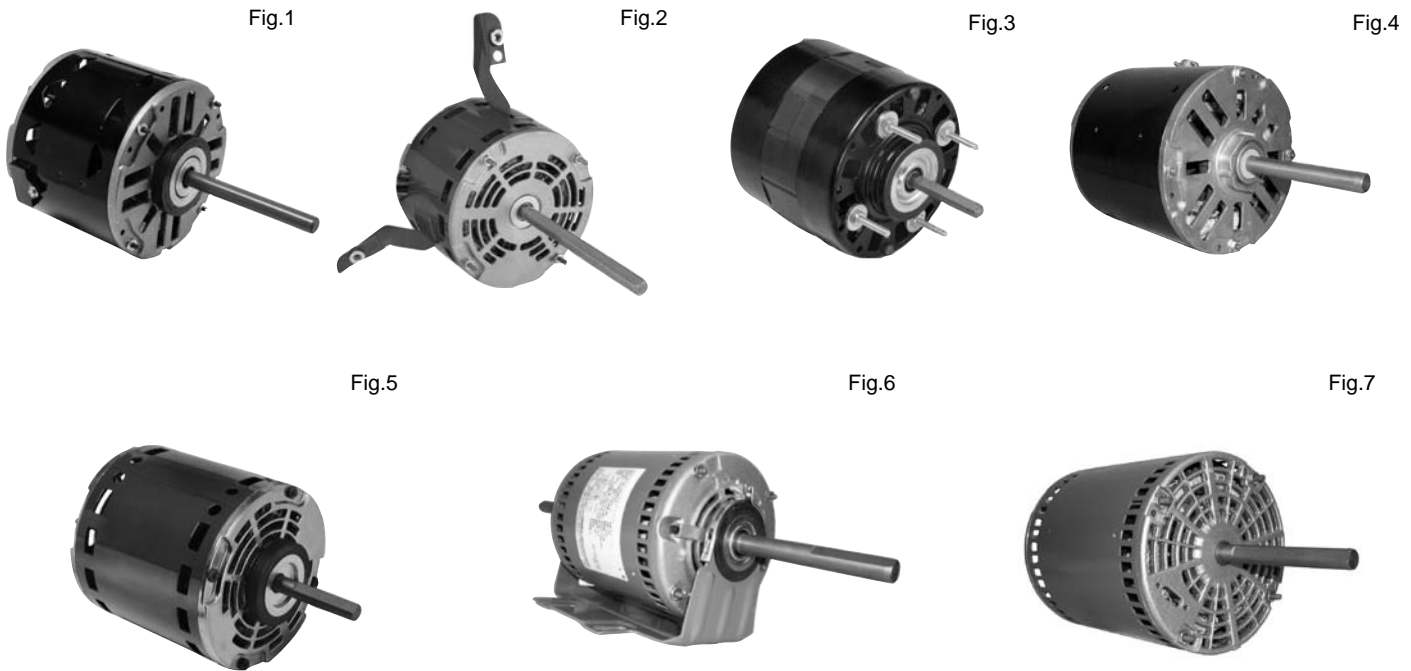

Lennox

Part #	HP	Spd/RPM	Volts	Amps	Rot	Type	Dia	Body	Shaft	Comment	Fig
R42133	1/4	3/1075	208/230	1.50	R.P.	5/370	5.5"	4.30"	6.5"x1/2"	P-8-1988, 3132, 4127, 4545	1
R42449	1/4	3/1075	208/230	1.50	R.P.	7.5/370	5.5"	4.10"	6.0"x1/2"	9" & 10" Blowers	2
R42419	1/4	3/1075	115	3.20	R.P.	7.5/370	5.5"	4.10"	6.0"x1/2"	9" & 10" Blowers	2
R32117	1/3	1/825	230	3.00	Rev	5/370	5.5"	5.50"	5.5"x1/2"	S3050, P-8-2948, 9080, D2817, 5KCP39PG971S	3
R22746	1/3	2/1075	208/230	2.10	R.P.	7.5/370	5.5"	4.80"	6.5"x1/2"	Condenser Fan	4
R42349	1/3	3/1075	208/230	2.10	R.P.	7.5/370	5.5"	4.60"	6.0"x1/2"	9" & 10" Blowers	2
R42319	1/3	3/1075	115	4.20	R.P.	7.5/370	5.5"	4.60"	6.0"x1/2"	9" & 10" Blowers	2
R42310	1/3	4/1075	115	6.40	Rev	5/370	5.5"	4.80"	6.0"x1/2"	P-8-7505, 9450, 41A4201	3
DD-035	1/3	4/1075	115	4.80	Rev	PSC/INC	5.5"	4.25"	4.0"x1/2"	P-8-7505	2
UE-117	1/3	1/1075	208/230	2.00	Rev	10/370	5.5"	6.00"	6.0"x1/2"	S3050, P-8-9662	4
R22242	1/2	2/1075	208/230	2.50	R.P.	10/370	5.5"	5.10"	6.5"x1/2"	Condenser Fan	4
R42249	1/2	3/1075	208/230	2.70	R.P.	10/370	5.5"	5.10"	6.0"x1/2"	9" & 10" Blowers	2
R32730	3/4	2/1075	208/230	3.50	Rev	15/370	5.5"	5.50"	6.5"x1/2"	Condenser Fan	4
R42043	3/4	3/1075	208/230	4.10	R.P.	10/370	5.5"	5.30"	6.0"x1/2"	9" & 10" Blowers	2
R42013	3/4	3/1075	115	7.90	R.P.	15/370	5.5"	5.30"	6.0"x1/2"	9" & 10" Blowers	1
UE-9405	3/4	5/1075	115	10.40	CCW	40/370	5.5"	5.25"	3.0"x1/2"	20F0101, 58H2201, EMK55HXWNZ7057	4
UE-9404	3/4	5/1075	230	5.60	CW	20/370	5.5"	7.75"	3.0"x5/8"	9404 P-8-8711, EMK55HXKGN-3291, 58H2201 9406 28F01011, EMK55HXWNZ7057, 58H2201	4
R43520	3/4	3/1075	460	2.00	CCW	20/370	5.5"	5.53"	2.5"x1/2"	43G5201	5
R52820	3/4	3/1075	208/230	4.20	CW	10/370	5.5"	7.80"	5.3"x5/8"x4.8"	31C8201	6
R32050	3/4	3/1025	575	1.65	Rev	15/370	5.5"	6.50"	4.0"x1/2"	Commercial Rooftop	7
R32051	3/4	3/1075	460	2.15	Rev	15/370	5.5"	6.63"	4.0"x1/2"	43G52	7

Fig.1



Fig.2



Fig.3



Fig.4



Fig.5

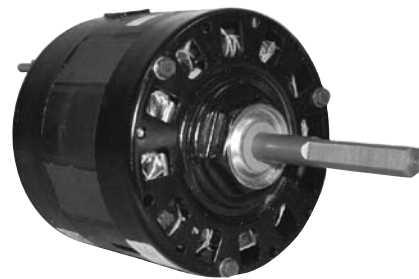

Liebert

Part #	HP	Spd/RPM	Volts	Amps	Rot	Type	Dia	Body	Shaft	Comment	Fig
T2535	3/4	1/1140	575	1.40	Rev	3 Ph	6.5"	8.10"	3.0"x5/8"	1C16992P1	1
T2531	3/4	1/1100	208/230 460	4.00	Rev	3 Ph	6.5"	8.10"	3.0"x5/8"	1C16992P1	1

Life Breath - Nutech

Part #	HP	Spd/RPM	Volts	Amps	Rot	Type	Dia	Body	Shaft	Comment	Fig
R465	1/15	3/1550	115	2.25	CCW	SP	3.3"	4.00"	2.3"x5/16"x2.3	23202	2

Lincoln

Part #	HP	Spd/RPM	Volts	Amps	Rot	Type	Dia	Body	Shaft	Comment	Fig
R213	1/25	1/1550	115	1.40	CCW	SP	3.3"	3.10"	1.7"x5/16"	CM88953	3

Lord Burnham

Part #	HP	Spd/RPM	Volts	Amps	Rot	Type	Dia	Body	Shaft	Comment	Fig
S1100	1/3	1/1625	115	3.80	Rev	PSC/INC	5.5"	8.50"	1.9"x5/8"	Louwer Fans	4

Magic Chef

Part #	HP	Spd/RPM	Volts	Amps	Rot	Type	Dia	Body	Shaft	Comment	Fig
R2691	1/5	1/1075	208/230	1.50	CW	5/370	5.0"	4.00"	3.9"x1/2"	35035B001	5

Rotation determined opposite shaft end
Double shaft determined at lead end

Shaft length measured from
hub face to shaft end

Fig.1

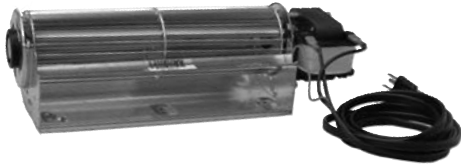

Fig.2

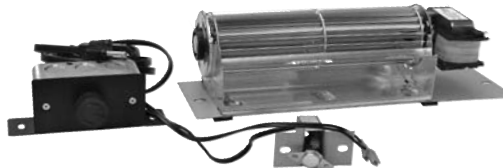

Fig.3



Fig.4



Fig.5



Fig.6



Fig.7

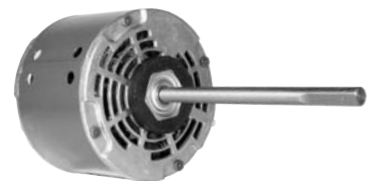

Majestic

Part #	Watts	Spd/RPM	Volts	Amps	Rot	Type	Dia	Body	Shaft	Comment	Fig
RB12	50	1/1250	115	0.86	CW	SP	Skel	12.9"x4.3"x3.6"	-	FK12	1
RB64	50	1/1200	115	0.86	CW	SP	Skel	12.9"x4.3"x3.6"	-	FA20, FK24, RHE32, 18L46, HE30, HE32	1
RB65	50	1/1250	115	0.86	CW	SP	Skel	12.9"x4.3"x3.6"	-	FK24, 33DBVRRN, DBT33, 36, 39, DBR33, 36, 39	2
RB63	50	1/1250	115	0.86	CW	SP	Skel	12.9"x4.3"x3.6"	-	RB65 blower & base only	2
RB130	53	1/2800	115	0.92	CW	SP	Skel	8"x4.56"x4.32"	-	FK30, 52425	3

Mark Hot

Part #	HP	Spd/RPM	Volts	Amps	Rot	Type	Dia	Body	Shaft	Comment	Fig
R350	1/55	2/1050	115	1.20	CW	SP	3.3"	2.85"	1.5"x5/16"	5AA1A3-P4S	4
R133	1/40	2/1550	115	1.00	CCW	SP	3.3"	2.60"	-	5DH1A1-P456	5

McQuay Remington

Part #	HP	Spd/RPM	Volts	Amps	Rot	Type	Dia	Body	Shaft	Comment	Fig
R52430	1/4	3/1060	208/230	1.50	CW	3/370	5.5"	4.50"	4.1"x1/2"x4.7"	24303, KCP39KGV3735	6
R10810	1/3	1/1625	208/230	2.70	CW	3/370	5.5"	4.50"	7.5"x1/2"	10810, CP39GG1964BS	7

Fig.1



Fig.2



Fig.3



Fig.4



Fig.5

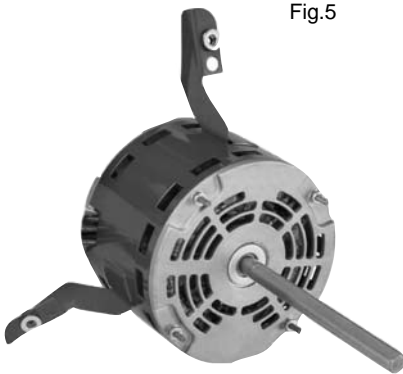

Fig.6



Fig.7



Fig.8



Miami Carey

Part #	HP	Spd/RPM	Volts	Amps	Rot	Type	Dia	Body	Shaft	Comment	Fig
R206	1/80	2/1550	115	0.56	CW	SP	3.3"	2.09"	1.4"x1/4"	Vent Fan	1
R203	1/70	1/1550	115	0.80	CCW	SP	3.3"	2.10"	1.5"x1/4"	1V2430	2
R214	1/50	1/2700	115	0.76	CW	SP	3.3"	2.80"	1.5"x1/4"	Vent Fan	1
R200	1/50	2/3000	115	1.00	CCW	SP	3.3"	2.60"	1.2"x1/4"	Vent Fan	1
R610	1/50	1/2400	115	1.00	CW	SP	Skel	0.90"	1.2"x7/32"	1V4217	3
R209	1/45	1/1550	115	0.87	CW	SP	3.3"	2.30"	1.5"x5/16"	1V3117, 39328	1
R220	1/20	1/1550	115	1.60	CCW	SP	3.3"	2.80"	1.2"x5/16"	1V2429	1

Miller Furnace

Part #	HP	Spd/RPM	Volts	Amps	Rot	Type	Dia	Body	Shaft	Comment	Fig
R2326	1/7	1/1050	115	4.70	CCW	SP	5.0"	3.30"	3.0"x1/2"	U.E. 326	4
R2393	1/5	1/1050	115	6.00	CCW	SP	5.0"	3.80"	5.8"x1/2"	OML6433	5

Montego, Selkirk

Part #	HP	Spd/RPM	Volts	Amps	Rot	Type	Dia	Body	Shaft	Comment	Fig
RF100-2	1/167	2/3000	115	0.50	CCW	SP	Skel	2.75"	-	2811-581-001, EF100, RF100, 2811-581-002, EF100-2	6

Moyer & Diebel

Part #	HP	Spd/RPM	Volts	Amps	Rot	Type	Dia	Body	Shaft	Comment	Fig
R320	1/100	1/1550	115	0.47	CW	SP	3.3"	2.10"	1.3"x1/4"	EM12	7
R307	1/30	1/3000	115	1.10	CCW	SP	3.3"	3.30"	1.3"x1/4"	Furnace Blower	8

Rotation determined opposite shaft end
Double shaft determined at lead end

Shaft length measured from
hub face to shaft end

Fig.1



Fig.2

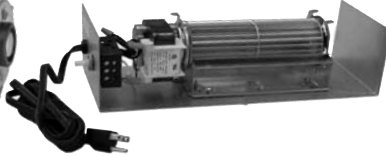

Fig.3



Fig.4



Fig.5



Fig.6



Fig.7



Fig.8



Napoleon

Part #	Watts	Spd/RPM	Volts	Amps	Rot	Type	Dia	Body	Shaft	Comment	Fig
RB61	42	1/1400	115	0.75	CCW	SP	Skel	10.5"x4.3"x3.6"	-	GZ552	1
RB62	42	1/1400	115	0.75	CCW	SP	Skel	14.1"x5.25"x3.5"	-	EP62-1	2
RB58	42	1/1400	115	0.75	CCW	SP	Skel	10.5"x4.3"x3.6"	-	GZ550, BCDV36NTR, GD36NTR,	3
RB59	42	1/1400	115	0.75	CCW	SP	Skel	10.5"x4.3"x3.6"	-	RB58 Blower & Base only	3

Newmac

Part #	HP	Spd/RPM	Volts	Amps	Rot	Type	Dia	Body	Shaft	Comment	Fig
R403	1/145	1/1550	115	0.33	CW	SP	3.3"	2.75"	1.5"1/4"	Heaters	4
RB33	1/55	1/3200	115	0.88	CW	SP	3.3"	6.60"	-	2040001	5

Nordica

Part #	HP	Spd/RPM	Volts	Amps	Type	Rot	Dia	Body	Shaft	Comment	Fig
RB513	-	1/2600	115	1.25	SP	CW	Skel	17.6"x4.25"x3"	-	J513	6
RB571	-	1/1800	115	0.38	SP	CCW	Skel	9.8"x3.7"x3.2"	-	J571	7
RB3	1/50	1/3000	115	0.80	SP	CW	3.3"	5.50"	-	UE383, B24220	8

OEM

Fig.1



Fig.2



Fig.3



Fig.4



Fig.5

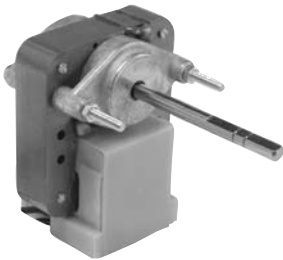

Fig.6



Fig.7

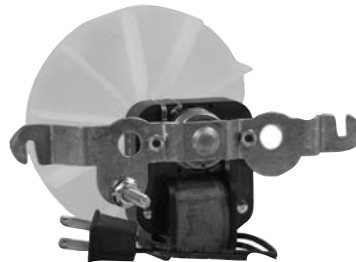

Fig.8



Nordyne, Frigidaire, Miller

Part #	HP	Spd/RPM	Volts	Amps	Rot	Type	Dia	Body	Shaft	Comment	Fig
RFB903	1/45	1/3000	115	1.10	CCW	SP	3.3"	5.60"	-	902977	1
RFB902	1/19	1/3450	115	0.70	CCW	PSC/INC	3.3"	5.50"	-	903111	2

Nutech

Part #	HP	Spd/RPM	Volts	Amps	Rot	Type	Dia	Body	Shaft	Comment	Fig
R465	1/15	3/1550	115	2.30	CCW	SP	3.3"	4.00"	2.3"x5/16"x2.1"	23202	3
R2655	1/12	1/1550	115	1.10	CCW	5/370	5.0"	3.00"	2.9"x1/2"x2.8"	AO812B2355	4
R2324	1/12	1/1550	115	1.40	CCW	PSC/INC	5.0"	3.75"	2.9"x3/8"x2.6"	23-204	4

Nutone

Part #	HP	Spd/RPM	Volts	Amps	Rot	Type	Dia	Body	Shaft	Comment	Fig
R613	1/260	1/1600	115	0.55	CW	SP	Skel	0.65"	2.5"x7/32"	64620	5
R506	1/240	1/1400	115	0.43	CW	SP	3.3"	1.90"	2.0"x1/4"	80725	6
R3100	1/130	1/3000	115	0.50	CW	SP	Skel	0.65"	1.7"x7/32"	C65878	5
RB11	1/130	1/3000	115	0.65	CW	SP	Skel	0.60"	1.7"x7/32"	118445, 208370856	7
R311	1/100	1/1550	115	0.47	CW	SP	3.3"	2.09"	1.2"x5/16"	81176	8
R315	1/90	1/1550	115	0.53	CCW	SP	3.3"	2.09"	1.2"x1/4"	82598, 82599, 65070	8
R604	1/85	1/2700	115	0.92	CW	SP	Skel	0.65"	1.2"x0.181"	Vent Fan	5

Rotation determined opposite shaft end
Double shaft determined at lead end

Shaft length measured from
hub face to shaft end

Fig.1

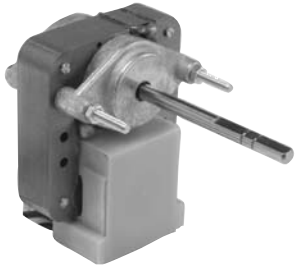

Fig.2



Fig.3



Fig.4

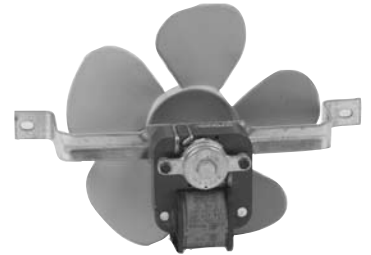

Fig.5



Fig.6



Fig.7



Nutone

Part #	HP	Spd/RPM	Volts	Amps	Rot	Type	Dia	Body	Shaft	Comment	Fig
R3101	1/80	2/3000	115	0.70	CCW	SP	Skel	0.70"	1.6"x7/32"	C52367, C27987	1
R232	1/70	2/1550	115	0.70	CCW	SP	3.3"	2.50"	1.3"x1/4"	80215, 80675, 26733	2
R207	1/70	1/1550	115	0.80	CW	SP	3.3"	2.00"	1.5"x1/4"	80100, 23405, 23388	2
R3103	1/70	1/3000	115	0.75	CW	SP	Skel	0.80"	2.4"x7/32"	C63676, C66582, C68626	1
R203	1/70	1/1550	115	0.80	CCW	SP	3.3"	2.10"	1.5"x1/4"	Vent Fan	2
R317	1/65	1/1550	115	0.60	CCW	SP	3.3"	2.30"	1.6"x1/4"	65072	3
R305	1/60	1/2800	115	0.85	CW	SP	3.3"	2.30"	1.5"x1/4"	80695	3
RB10	1/60	1/2400	115	1.00	CW	SP	Skel	0.90"	1.2"x7/32"	279932	4
R610	1/60	2/2400	115	1.00	CW	SP	Skel	0.90"	1.2"x7/32"	27898, 64586, 64964, 67846, 81734, 81795, 81798, 81800	1
R201	1/50	1/1430	115	0.85	CW	SP	3.3"	2.20"	2.3"x1/4"	18692	2
R319	1/50	1/1430	115	0.90	CCW	SP	3.3"	2.10"	2.2"x1/4"	Vent Fan	3
R209	1/45	1/1550	115	0.87	CW	SP	3.3"	2.30"	1.5"x5/16"	80101, 80230, 80469	2
R233	1/45	2/3000	115	0.84	CCW	SP	3.3"	2.50"	1.8"x1/4"	81894, 22721	2
R304	1/40	1/1550	115	0.89	CW	SP	3.3"	2.50"	1.5"x1/4"	Vent Fan	3
R202	1/40	2/1550	115	1.00	CW	SP	3.3"	2.50"	1.3"x1/4"	81487, 82879	2
R470	1/25	1/1550	115	1.40	CW	SP	3.3"	3.00"	3.8"x5/16"x3.7"	Vent Fan	5
R219	1/20	1/1550	115	1.60	CW	SP	3.3"	2.80"	2.2"x5/16"	80405, 80747	2
R440	1/20	1/1550	115	1.60	CW	SP	3.3"	3.15"	3.8"x5/16"x3.8"	81905, 807834, 26757	6
R355	1/15	1/1550	115	2.20	CW	SP	3.3"	3.11"	1.9"x5/16"	81918	7

Fig.1



Fig.2



Fig.3



Fig.4



Fig.5

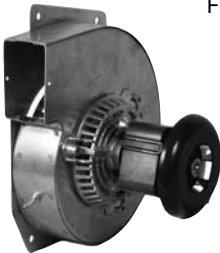

Fig.6

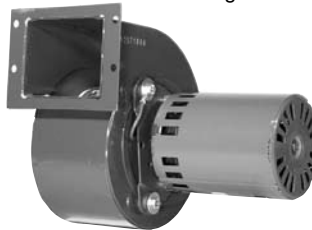

Fig.7

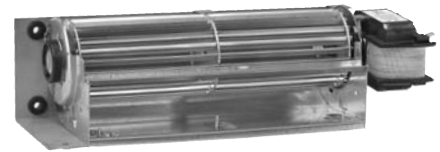

Fig.8



Fig.9



Olsen

Part #	HP	Spd/RPM	Volts	Amps	Rot	Type	Dia	Body	Shaft	Comment	Fig
RFB181	1/54	1/3200	115	1.20	CW	SP	3.3"	6.60"	-	18102, c/w gaskets	1
RFB200	1/54	1/3200	115	1.20	CCW	SP	3.3"	6.60"	-	20082, 11051403	1
RFB090	1/50	1/3000	115	1.10	CCW	SP	3.3"	-	-	26986, 26987	2
RFB140	1/49	1/3400	115	1.40	CCW	SP	3.3"	5.60"	-	4246100, JAIN107NS	3
RFB112	1/45	1/3000	115	1.30	CCW	SP	3.3"	6.00"	-	26986, 26987, 28436	4
RFB111	1/25	1/3000	115	1.10	CCW	SP	3.3"	-	-	26607, c/w, gaskets & mounting plates	4
RFB467	1/30	1/3000	115	1.70	CW	SP	Skel	5.94"	-	29467	5
RFB203	1/20	1/3000	230	0.90	CCW	SP	3.3"	8.50"	-	3255A	6
RFB130	1/18	1/3450	115	0.70	CCW	PSC/INC	3.3"	5.00"	-	4246101	3

Osburn

Part #	Watts	Spd/RPM	Volts	Amps	Rot	Type	Dia	Body	Shaft	Comment	Fig
RB108	50	1/1250	115	0.86	CW	SP	Skel	12.9"x4.3"x3.6"	-	KA108	7
RB006	81	2/2800	115	1.40	CCW	SP	skel	12.8"x4.6"x4.3"	-	FD006-1600, 1800, 2200, 2400	8

Pacific Energy Esteem

Part #	Watts	Spd/RPM	Volts	Amps	Rot	Type	Dia	Body	Shaft	Comment	Fig
RB50	53	1/2400	115	0.92	CW	SP	Skel	12.8"x4.6"x4.3"	-	5053-947, MNB.BLOW, ENCD.BLOW	9

Rotation determined opposite shaft end
Double shaft determined at lead end

Shaft length measured from
hub face to shaft end

Fig.1

Fig.2

Fig.3

Fig.4



Fig.5

Fig.6

Fig.7

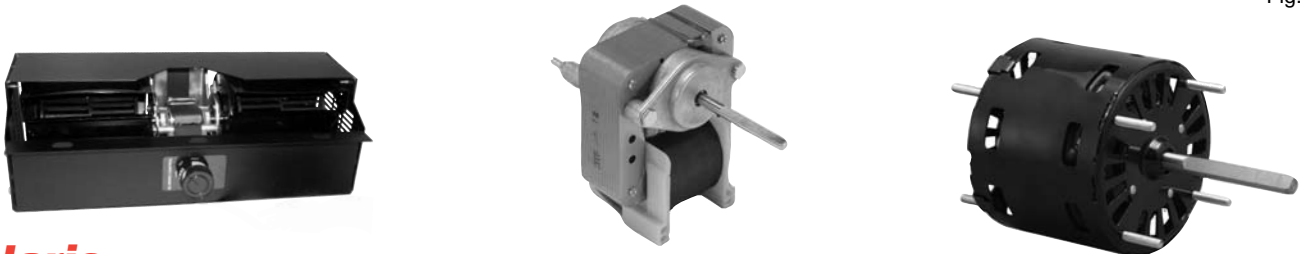

Polaris

Part #	Watts	Spd/RPM	Volts	Amps	Rot	Type	Dia	Body	Shaft	Comment	Fig
RB944	17	1/2900	115	0.77	CCW	SP		10.3"x3.6"x3.6"	-	PG200	1

Prestcold

Part #	HP	Spd/RPM	Volts	Amps	Rot	Type	Dia	Body	Shaft	Comment	Fig
R5421	9W	1/1550	208/230	0.29	CW	SP	3.5"	2.80"	HUBLESS	401-0030-01	2
R5411	9W	1/1550	115	0.58	CW	SP	3.5"	2.80"	HUBLESS	401-0031-01	2
R5821	16W	1/1550	208/230	0.45	CW	SP	3.5"	3.10"	HUBLESS	401-0033-01	2
R5811	16W	1/1550	115	0.80	CW	SP	3.5"	3.10"	HUBLESS	401-0032-01	2
R2942	1/10	1/1550	115/208 /230	4.00	CCW	SP	5.0"	4.80"	2.3"x3/8"	401-0052-01	3
R32476	1/3	1/825	208/230	2.40	Rev	5/370	5.5"	5.30"	6.0"x1/2"	401-0048-01	4

QBD

Part #	HP	Spd/RPM	Volts	Amps	Rot	Type	Dia	Body	Shaft	Comment	Fig
R621	1/187	1/3000	115	0.40	CW	SP	Skel	0.55"	1.29"x0.1811"	QBD 47-0410-001, -022, -015, IN DC5 & DC7	6

Quadra Fire

Part #	Watts	Spd/RPM	Volts	Amps	Rot	Type	Dia	Body	Shaft	Comment	Fig
RB83	53	1/2400	115	0.92	CCW	SP	Skel	12.8"x4.6"x4.3"	-	Free Standindg Wood Stove Blower	5

Rapid Refrigeration

Part #	HP	Spd/RPM	Volts	Amps	Rot	Type	Dia	Body	Shaft	Comment	Fig
R602	1/125	1/3000	115	0.50	CW	SP	Skel	0.65"	1.4"x0.181"	5A140-93	6

Ref Plus

Part #	HP	Spd/RPM	Volts	Amps	Rot	Type	Dia	Body	Shaft	Comment	Fig
R368	1/20	1/1550	115	2.00	CW	SP	3.3"	2.75"	2.5"x5/16"	RMT0011, JA2N267N, 7173-1539	7
R369	1/20	1/1550	208/230	0.90	CW	SP	3.3"	2.75"	2.5"x5/16"	RMT0012, JA2N0268N, 7173-1538	7

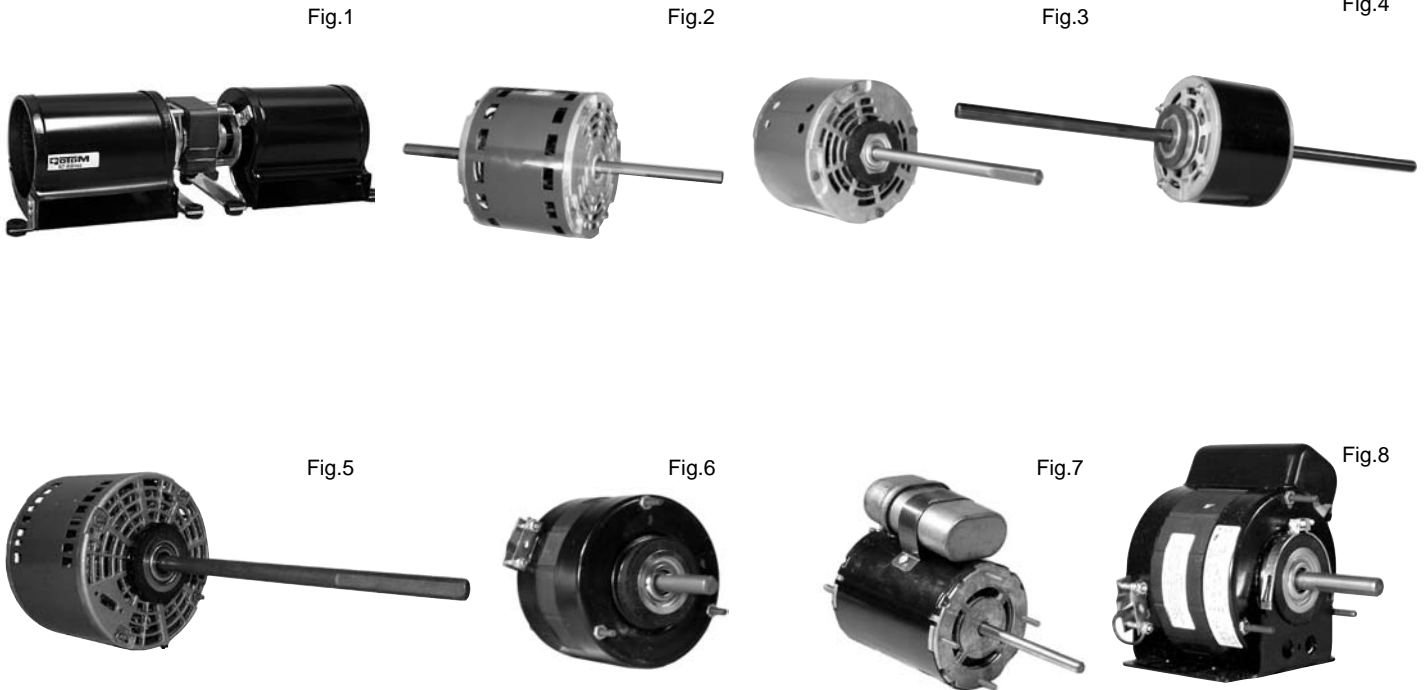

Regency

Part #	HP	Spd/RPM	Volts	Amps	Type	Rot	Dia	Body	Shaft	Comment	Fig
RB166	53	1/2400	CCW	0.92	SP	CCW	Skel	12.8"x4.6"x4.3"	-	910-33/P, -142/P, I1100, I2100, I3100	1
RB167	53	2/2800	CCW	0.92	SP	CCW	Skel	12.8"x4.6"x4.3"	-	910-157/P, F1100, F2100, F2400, F2400M, F3100	1

Remington - McQuay

Part #	HP	Spd/RPM	Volts	Amps	Rot	Type	Dia	Body	Shaft	Comment	Fig
R52430	1/4	3/1060	208/230	1.50	CW	7.5/370	5.5"	4.50"	4.1"x1/2"x4.7"	24303, 5KCP39KGV3735	2
R10810	1/3	1/1625	208/230	2.70	CW	3/370	5.5"	4.50"	7.5"x1/2"	10810, 5KCP39GG1964BS	3

Remington Singer

Part #	HP	Spd/RPM	Volts	Amps	Rot	Type	Dia	Body	Shaft	Comment	Fig
R2675	1/30	4/1075	208/230	0.40	CCW	2/370	4.75"	3.80"	7.7"x1/2"x7.7"	02024224	4
R139	1/8	1/1075	208/230	2.20	CW	4/5/370	5.5"	4.00"	9.0"x1/2"	21662R, 74007	5

Reversomatic (see Page 8)

Reznor

Part #	HP	Spd/RPM	Volts	Amps	Rot	Type	Dia	Body	Shaft	Comment	Fig
R2360	1/15	1/1050	115	2.20	CCW	SP	5.0"	3.30"	2.8"x1/2"	Unit Heater	6
RFM78	1/10	1/3000	115/230	1.30	Rev	PSC/INC	3.3"	4.10"	3.3"x5/16"	43846, 43424	7
R2615	1/8	1/1050	115	3.90	CCW	SP	5.0"	3.90"	2.7"x1/2"	Unit Heater	6
R12177	1/6	1/1075	115	2.20	CCW	PSC/INC	5.5"	4.60"	2.4"x1/2"	Unit Heater	8
R12486	1/4	1/1075	115	4.00	CCW	PSC/ INC	5.5"	4.60"	3.0"x1/2"	Unit Heater	8

Rotation determined opposite shaft end
Double shaft determined at lead end

Shaft length measured from
hub face to shaft end

Fig.1

Fig.2

Fig.3

Fig.4

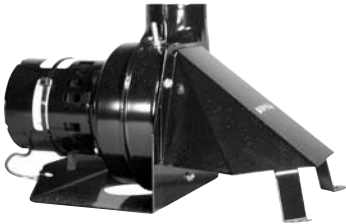

Fig.5

Fig.6

Fig.7

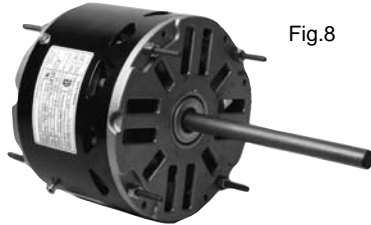

Fig.8

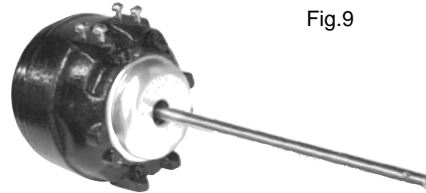

Fig.9

Rheem Ruud

Part #	HP	Spd/RPM	Volts	Amps	Rot	Type	Dia	Body	Shaft	Comment	Fig
RFB139	1/55	1/2970	115	0.95	CCW	SP	3.3"	11.00"	-	SP11608	1
RFB090	1/50	1/3000	115	1.10	CCW	SP	3.3"	5.00"	-	70-214196-01, c/w gaskets	2
RFB214	1/50	1/3000	115	1.10	CW	SP	3.3"	5.63"	-	70-214196-83, A079, c/w gaskets	2
RFB107	1/40	2/3350	208 /230	0.30	CW	3/370	3.3"	8.70"	-	1070770, 101070, 107701, c/w gasket	3
RFB189	1/40	1/3000	115	1.00	CCW	SP	3.3"	5.50"	-	09-189	4
RFB142	1/25	1/3450	115	0.70	CCW	INC	3.3"	6.00"	-	70-22162-81	5
RFB241	1/20	1/3400	115	1.71	CCW	SP	Skel	6.30"	-	70-24157-03, 70-22838-02	6
RFB136	1/20	1/3450	115	0.75	CCW	INC	3.3"	6.25"	-	70-24033-01, 7062-3861	5
R22847	1/8	1/825	208/230	0.70	R.P.	5/370	5.5"	4.20"	4.8"×1/2"	21267-01, 02, 20760-1, 20763-01	7
R22645	1/8	1/825	208/230	0.90	Rev	5/370	5.5"	4.30"	4.8"×1/2"	21276-01, -02, 512076-01	7
R22170	1/5	1/1075	208/230	1.60	Rev	5/370	5.5"	3.80"	6.0"×1/2"	D743, K136, 442	7
R22437	1/4	1/1075	208/230	1.60	R.P.	7.5/370	5.5"	3.8"	5.5"×1/2"	20761-01, 21185-01	8

Scotsman

Part #	HP	Spd/RPM	Volts	Amps	Rot	Type	Dia	Body	Shaft	Comment	Fig
R4119	15W	1/1550	115	0.60	CW	SP	3.9"	3.50"	5.0"×5/16"	Agitator	9

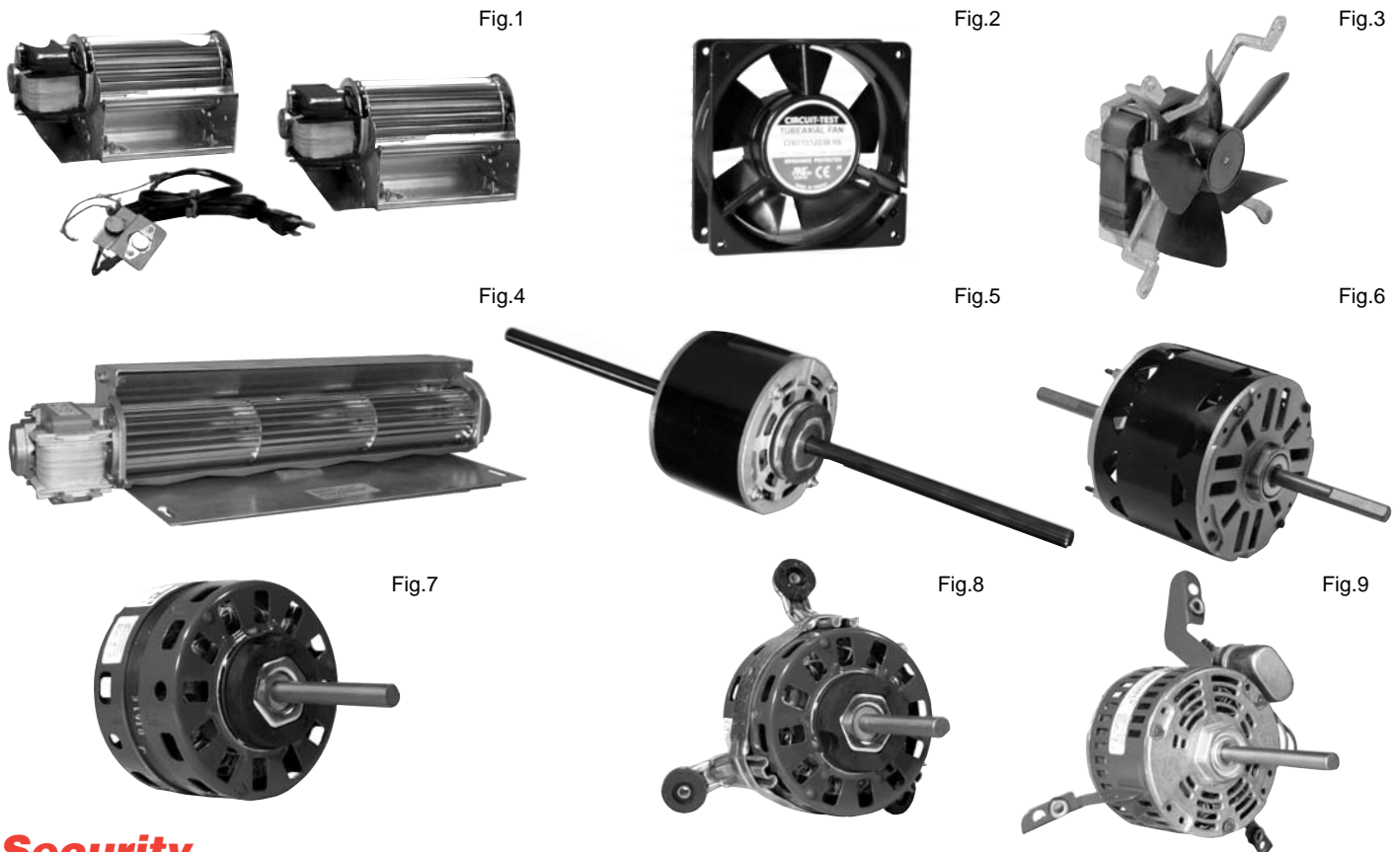

Security

Part #	Watts	Spd/RPM	Volts	Amps	Type	Rot	Dia	Body	Shaft	Comment	Fig
RB267	35	1/1800	115	0.75	SP	CCW	Skel	12.9"x4.3"x3.6"	-	UZY	1
RB67	35	1/1800	115	0.75	SP	CCW	Skel	12.9"x4.3"x3.6"	-	RB267 BLOWER ONLY	1
RF235	22	1/3100	115	-	SP	-	Axial	-	-	UZY Old BIS1 & BIS2	2

Selkirk Metalbestos

Part #	HP	Spd/RPM	Volts	Amps	Rot	Type	Dia	Body	Shaft	Comment	Fig
RB89	23	1/2050	115	0.46	CW	SP	Skel	10.4"x3.25"x2.8"	-	45mm Blower Kit	4
RB85	23	1/2050	115	0.46	CW	SP	Skel	10.4"x3.25"x2.8"	-	RB89 Blower Only	4
RB88	35	1/1900	115	0.60	CW	SP	Skel	15.4"x3.25"x2.8"	-	45mm Blower Kit	4
RB87	35	1/1900	115	0.60	CW	SP	Skel	15.4"x3.25"x2.8"	-	RB88 Blower Only	4
RF100-2	1/155	1/3000	115	0.50	CCW	SP	Skel	0.65"	-	c/w Blade & Bracket	3

Singer

Part #	HP	Spd/RPM	Volts	Amps	Rot	Type	Dia	Body	Shaft	Comment	Fig
R2675	1/30	4/1075	208/230	0.40	CCW	2/370	5.0"	3.80"	7.7"x1/2"x7.7"	02024224	5
R52150	1/4	3/1025	208/230	2.00	CW	7.5/370	5.5"	4.30"	4.5"x1/2"x4.2"	02024246	6

Snyder General

Part #	HP	Spd/RPM	Volts	Amps	Rot	Type	Dia	Body	Shaft	Comment	Fig
R2198	1/14	3/820	115	1.30	CCW	7.5/370	5.0"	4.50"	3.4"x1/2"	c/w Plug	7
R2197	1/14	3/820	115	1.30	CCW	7.5/370	5.0"	4.50"	3.4"x1/2"	Plug & 8.37" Bolt Circle	8
R2299	1/8	5/1000	115	2.00	CCW	PSC/INC	5.0"	3.30"	4.3"x1/2"	9"&10" Bolt Circle	9

Rotation determined opposite shaft end
Double shaft determined at lead end

Shaft length measured from
hub face to shaft end

Fig.1

Fig.2

Fig.3

Fig.4

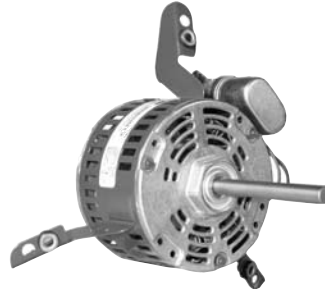
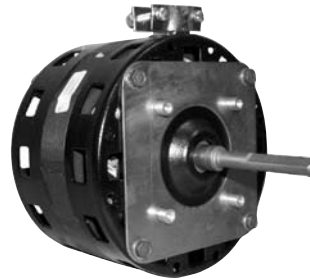

Fig.5

Fig.6

Fig.7

Fig.8



Tecumseh

Part #	HP/ Watts	Spd/RPM	Volts	Amps	Rot	Type	Dia	Body	Shaft	Comment	Fig
R5211	4	1/1550	115	0.29	CW	SP	3.8"	4.50"	Hubless	TFM41	4
R5311	6	1/1550	115	0.36	CW	SP	3.5"	2.80"	Hubless	TFM61	4
R5421	9	1/1550	208/230	0.29	CW	SP	3.5"	2.80"	Hubless	TFM91	4
R5411	9	1/1550	115	0.58	CW	SP	3.5"	2.80"	Hubless	TFM62, 92	4
R3512	35	1/1550	208/230	0.70	CW	SP	3.8"	3.50"	Hubless	TFM352	5
R3511	35	1/1550	115	1.40	CW	SP	3.8"	3.50"	Hubless	TFM351	5
R5122	50	1/1550	208/230	0.85	CW	SP	3.8"	4.00"	2.0"×5/16"	TFM502	6
R2372	1/20	1/1550	230	1.10	CW	SP	5.0"	3.00"	2.8"× 3/8"	TFM372	7
UE-9488	1/20	1/1500	115	1.7	CW	SP	5.0"	4.87"	2 1/8"× 5/16"	TMF191, TFM265, 810E019A080, EM F33HXGFG-2876	8
UE-9487	1/12	1/1500	230	1.3	CW	SP	5.0"	4.87"	2 1/8" × 5/16"	TFM262, 810E026A81, EM F33HXDJ-3668	8

Temspec

Part #	HP	Spd/RPM	Volts	Amps	Rot	Type	Dia	Body	Shaft	Comment	Fig
R2198	1/14	3/820	115	1.30	CCW	7.5/370	5.0"	4.50"	3.4"×1/2"	c/w Plug	1
R2194	1/14	3/820	115	1.25	CCW	7.5/370	5.0"	4.00"	3.4"×1/2"	DE3E141N	3
R2195	1/14	3/740	115	2.10	CCW	7.5/370	5.0"	4.60"	3.4"×1/2"	DE3F056N	3
R2197	1/14	3/820	115	1.30	CCW	7.5/370	5.0"	4.50"	3.4"×1/2"	Plug & 8.37" Bolt Circle	2
R2196	1/8	3/850	115	2.50	CCW	7.5/370	5.0"	4.50"	3.9"×1/2"	DE3G110N	3
DD-029	1/8	5/1000	115	2.10	CCW	PSC/INC	5.0"	3.57"	5.0"×1/2"	L350, L450, L600, DA3E200, DA3F100, DA3G142, R2299	3

Fig.1

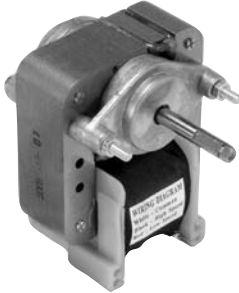

Fig.2



Fig.3



Fig.4



Fig.5

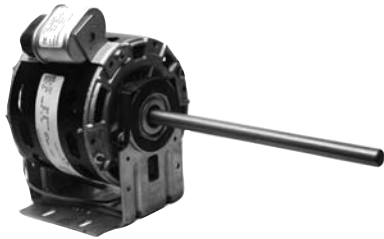

Fig.5



Fig.6



Fig.7



Fig.8



Fig.9

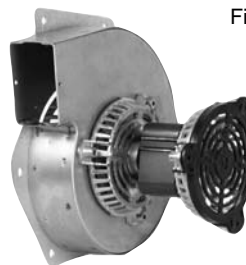

Torin

Part #	HP	Spd/RPM	Volts	Amps	Rot	Type	Dia	Body	Shaft	Comment	Fig
R610	1/50	2/3000	115	0.91	CW	SP	Skel	0.87"	1.2"x7/32"	7627171	1
R334	1/15	1/3000	115	2.30	CCW	SP	3.3"	4.25"	1.5"x1/4"	7627181,221, 271, 291	2

Trane

Part #	HP	Spd/RPM	Volts	Amps	Rot	Type	Dia	Body	Shaft	Comment	Fig
RFB143	1/45	1/3000	115	0.95	CCW	S.P.	3.3"	-	--	MID EFF. FURNACE	3
RFB380	1/40	1/2800	208/230	0.25	CCW	PSC/ 2/370	3.3"	8.10"	-	X38040036037	4
UE-954	1/30	3/1100	115	0.60	CW	PSC/Inc	5.0"	4.00"	8.5"x1/2"	MOT1878,1875	5
UE-641	1/30	3/1075	115	0.50	CW	PSC/Inc	5.0"	3.50"	8"x1/2"x9"	MOT1876	7
RFB73	1/30	1/3000	115/230	0.82	CW	SP	3.3"	5.30"	-	38040252	6
RFB787	1/30	1/3000	115	1.20	CW	SP	Skel	6.00"	-	787P01	9
R213	1/25	1/1550	115	1.10	CCW	S.P.	3.3"	2.90"	1.8" x 5/16"	70200011	8
R303	1/25	1/1550	115	1.50	CCW	S.P.	3.3"	3.80"	3.3" x 5/16"	70270010	8
UE-9608	1/20	3/1100	115	0.60	Rev	PSC/Inc	5.0"	3.25"	9.5"x1/2"	MOT1875	5
RFB130	1/18	1/3000	115	0.70	CCW	S.P.	3.3"	--	--	HIGH EFF. FURNACE	9
UE-953	1/15	3/1100	115	0.80	CW	PSC/Inc	5.0"	3.25"	10.5"x1/2" x10.5"	MOT1877	7
UE-945	1/8	3/1500	115	1.20	CE	PSC/Inc	5.0"	4.00"	9"x1/2" x7.5"	MOT1978, 481	7

Rotation determined opposite shaft end
Double shaft determined at lead end

Shaft length measured from
hub face to shaft end

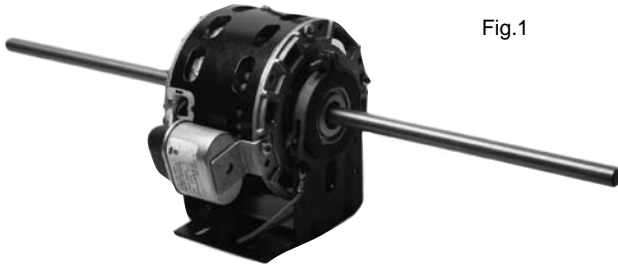

Fig.1

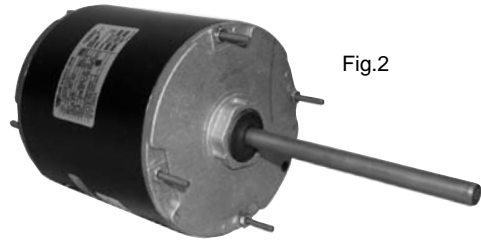

Fig.2

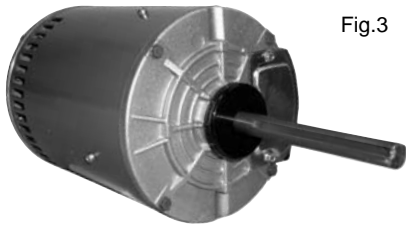

Fig.3

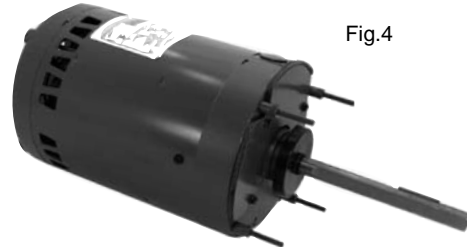

Fig.4

Trane

Part #	HP	Spd/RPM	Volts	Amps	Rot	Type	Dia	Body	Shaft	Comment	Fig
UE-955	1/6	3/1500	115	2.00	CW	PSC/Inc	5.0"	4.00"	10.5"x1/2" x10.5"	MOT1979, 482	1
R42604	1/3	1/1100	575	0.80	R.P.	P.S.C. /7.5/370	5.5"	5.80"	6.0" x 1/2"	MOT2604	2
R42606	1/2	1/1125	575	1.3	REV	P.S.C. /7.5/370	5.5"	5.50"	6.0" x 1/2"	MOT2606	2
R42605	1/2	1/1625	575	0.90	CW	P.S.C. /15/370	5.5"	7.30"	6.0" x 1/2"	MOT2605	2
R42607	3/4	1/1075	575	1.60	REV	P.S.C. /15/370	5.5"	5.50"	6.0" x 1/2"	MOT2607	2
S1454	1	1/1075	208/230 /460	5.20	REV	P.S.C. /12.5/370	6.5"	8.70"	6.0" x 5/8"	MOT2461	3
T2538	1	1/1140	208/230 /460	4.10	REV	3PH	6.5"	9.10"	5.0" x 5/8"	MOT2463	3
T2540	1	1/1140	575	1.70	REV	3PH	6.5"	9.10"	5.0" x 5/8"	MOT2914	3
C770	1	1/1075	208/230 460	4.80	REV	PSC/ 25/370	6.5"	10.75"	6.0"x5/8"	MOT2461	4
S1456	1 1/2	1/1075	208/230 /460	6.80	REV	P.S.C. /25/370	6.5"	10.50"	6.0" x 5/8"	MOT2462	3
T2542	1 1/2	1/1140	208/230 /460	5.40	REV	3PH	6.5"	10.10"	5.0" x 5/8"	MOT2464	3
T2543	1 1/2	1/1140	575	2.30	REV	3PH	6.5"	10.10"	5.0" x 5/8"	MOT1590	3
C771	1 1/2	1/1075	208/230 460	6.60	REV	PSC 25/370	6.5"	12.00"	6.0"x5/8"	MOT2462	4

Fig.1



Fig.2



Fig.3



Fig.4

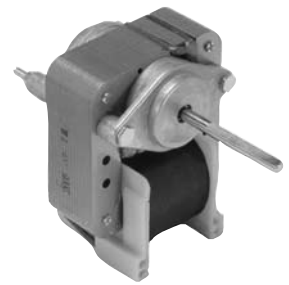

Fig.5

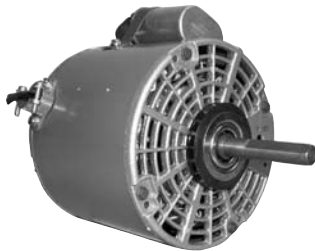

Fig.6



Fig.7



Tweed Steel

Part #	HP	Spd/RPM	Volts	Amps	Rot	Type	Dia	Body	Shaft	Comment	Fig
R500	1/70	1/1550	115	0.66	CCW	SP	3.3"	2.35"	1.6"x5/16"	23197211	1

Tyler

Part #	HP	Spd/RPM	Volts	Amps	Rot	Type	Dia	Body	Shaft	Comment	Fig
R5715	15W	1/1550	115	0.37	CW	SP	3.5"	3.50"	-	5215879	2
R5720	15W	1/1550	115	0.38	Rev	SP	3.5"	3.50"	-	5212930	3
R109	1/135	1/1550	115	0.55	CW	SP	3.3"	1.72"	0.8 Hubless	Evaporator Fan	3
R605	1/65	1/2800	115	0.84	CW	SP	Skel	0.88"	1.7"x0.1811	Evaporator Fan	4
R3042	1/4	1/1625	230	1.90	CCW	PSC/Inc	5.5"	4.80"	2.5"x1/2"	Ball Bearing	5

Unilux

Part #	HP	Spd/RPM	Volts	Amps	Rot	Type	Dia	Body	Shaft	Comment	Fig
DD-029	1/8	5/1000	115	2.60	CCW	PSC/INC	5.0"	3.75"	5.0"x1/2"	L350, L450, L600, DA3E200, DA3F100, DA3G142, R2299	6
DD-030	1/6	5/950	115	2.60	CCW	PSC/INC	5.5"	3.98"	4.4"x1/2"	5KCP39DEV2795	6

Vanee Heat Recovery Motor

Part #	Watts	Spd/RPM	Volts	Amps	Rot	Type	Dia	Body	Shaft	Comment	Fig
R348	1/15	1/1550	115	1.12	CW	PSC	3.3"	4.0"	3.2"x5/16	M1703	7

Rotation determined opposite shaft end
Double shaft determined at lead end

Shaft length measured from
hub face to shaft end

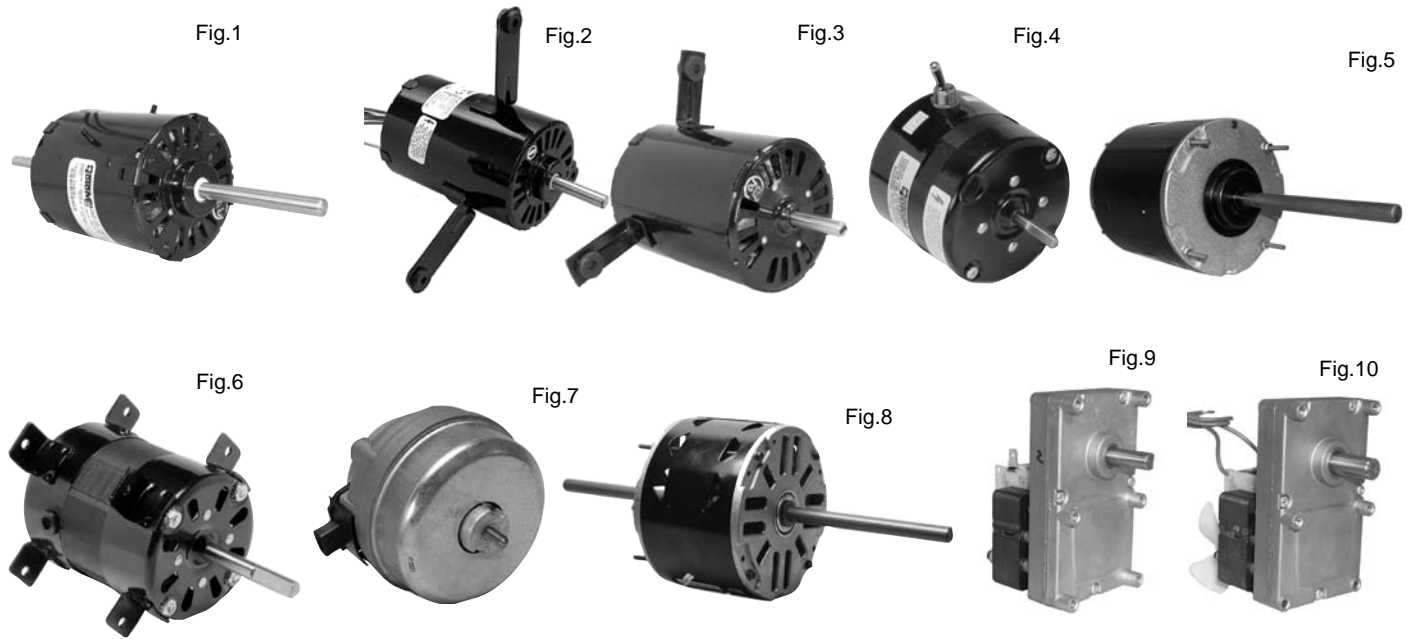

Venmar Make Up Air Unit 3.3" Motor

Part #	HP	Spd/RPM	Volts	Amps	Rot	Type	Dia	Body	Shaft	Comment	Fig
R462	1/8	3/1600	115	0.90	CW	7.5/370	3.3"	4.13"	3.5"x5/16"x3.5	02101	1
R438	1/7	2/1600	115	1.03	CW	4/370	3.3"	4.31"	1.55"x5/16"	01038	2
R366	1/4	3/1630	115	1.68	CW	7.5/370	3.3"	4.78"	2.97"x3/8"x3.0"	02100	1
R422	1/3	3/1690	115	2.89	CW	7.5/370	3.3"	4.93"	2.06"x3/8"	02209	3

B.D. Waite

Part #	HP	Spd/RPM	Volts	Amps	Rot	Type	Dia	Body	Shaft	Comment	Fig
R206	1/80	2/1550	115	0.56	CW	SP	3.3"	2.09"	1.4"x1/4"	Humidifiers	4

Weather King

Part #	HP	Spd/RPM	Volts	Amps	Rot	Type	Dia	Body	Shaft	Comment	Fig
R22645	1/8	1/825	208/230	0.90	Rev	PSC 5/370	5.5"	4.30"	4.8"x1/2"	D832, 21276-01	5
R22170	1/5	1/1075	208/230	1.60	Rev	PSC 5/370	5.5"	3.80"	6.0"x1/2"	K136, D746, 442	5

Westcan

Part #	HP	Spd/RPM	Volts	Amps	Rot	Type	Dia	Body	Shaft	Comment	Fig
R480	1/30	1/1550	208/230	0.80	CCW	SP	3.3"	4.00"	2.5"x3/8"	A2001B	6

Whirpool - Inglis

Part #	HP	Spd/RPM	Volts	Amps	Rot	Type	Dia	Body	Shaft	Comment	Fig
R5109	2W	1/1550	115	0.25	CW	SP	3.5"	2.50"	-	Condenser Fan	7
R859	1/3	3/1100	208/230	1.50	CCW	PSC 5/370	5.5"	3.90"	5.5"x1/2"x5.3"	R.A.C Delco Motors	8

Whitefield Auger Motors

Part #	HP	Spd/RPM	Volts	Amps	Rot	Type	Dia	Body	Shaft	Comment	Fig
RGM451	-	1/1.0	115	0.51	CCW	SP	-	3.00"	1.1"x3/8"	4514U1-063	9
RGM452	-	1/2.0	115	1.26	CCW	SP	-	3.10"	1.1"x3/8"	CDN.COMFORT IND. V07926AAD9, V002	9
RGM651	-	1/5.5	115	1.00	CCW	SP	-	3.25"	1.1"x1/2"	ECM2616	10

Fig.1



Fig.2



Fig.3

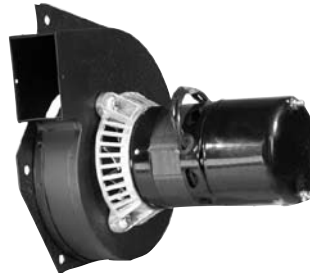

Fig.4



Fig.5



Fig.6



Fig.7



Fig.8

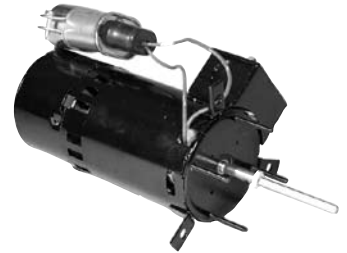

Fig.9



Fig.10



York

Part #	HP	Spd/RPM	Volts	Amps	Rot	Type	Dia	Body	Shaft	Comment	Fig
RFB63	1/60	1/3000	230	0.50	CCW	S.P.	3.3"	—	—	York 26-22239	1
RFB73	1/55	1/3000	115/230	0.45	CW	S.P.	3.3"	—	—	24-25100	2
RFB144	1/40	1/3000	230	0.50	CCW	S.P.	3.3"	—	—	024-24115-701	3
RFB296	1/40	1/3000	460	0.30	CCW	S.P.	3.3"	—	—	26-29600	3
RFB5	1/35	1/3000	115/230	1.40	CCW	S.P.	3.3"	—	—	26-20224	2
RFB137	1/25	1/3000	115	0.70	CCW	4/370	3.3"	—	—	24-23230,26-29620	4
RFM3	1/16	1/3400	230/460	0.40	CCW	S.P.	3.3"	6.3"	2.3" x 1/4"	U660	5
RFM653	1/16	1/3430	230/460	0.40	CW	S.P.	3.3"	6.3"	2.3" x 1/4"	U653	5
RFM680	1/16	1/3450	115/230	1.90	REV	P.S.C/inc	3.3"	4.9"	2.5" x 1/4"	24-25115-001, 24-25115-201	6
R2360	1/15	1/1050	115	2.20	CCW	S.P.	5.0"	3.3"	2.8" x 1/2"	Heating	7
RFM460	1/12	1/3200	460	0.30	REV	P.S.C/inc	3.3"	7.0"	2.5" x 1/4"	York	6
RFM410	1/10	1/3000	115/230	1.40	REV	P.S.C/inc	3.3"	7.1"	3.7" x 1/4"	D410, D412	8
R2615	1/8	1/1050	115	3.90	CCW	S.P.	5.0"	3.9"	2.7" x 1/2"	Heating	7
R760	1/8	3/1100	115	1.30	CW	12.5/370	5.5"	3.5"	2.0" x 1/2" x 2.8"	24-14098-000	9
R741	1/5	1/1075	208/230	1.40	CW	5/370	5.0"	3.9"	6.0" x 1/2" x 6.0"	24-17774-000	10

Fig.1



Fig.2



Fig.3

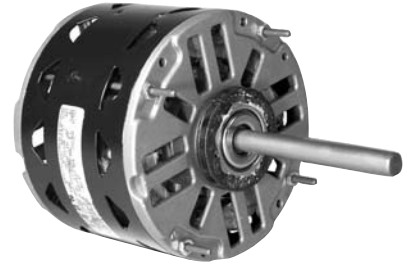

Fig.4



Fig.5

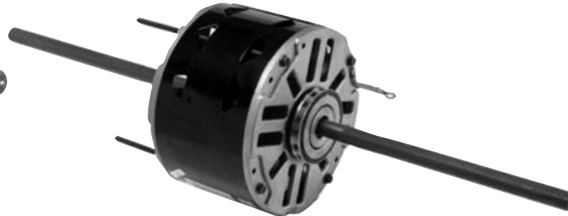

Fig.6

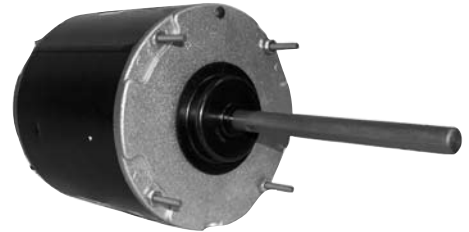

Fig.7

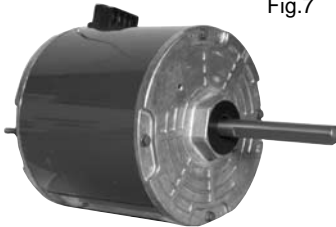

Fig.8



York

Part #	HP	Spd/RPM	Volts	Amps	Rot	Type	Dia	Body	Shaft	Comment	Fig
R770	1/5	3/1040	208/230	1.70	CW	3/370	5.5"	3.5"	2.0" x 1/2" x 6.2"	24-18431-000	1
R22455	1/4	1/1075	208/230	1.30	R.P.	5/370	5.5"	4.4"	6.0" x 1/2"	Heating	2
R43583	1/4	3/1075	115	4.80	REV	/5/370	5.5"	4.3"	6.0" x 1/2"	024-23206	3
S1502	1/3	1/1075	200/230 /460	2.80	REV	5/370	5.5"	7.3"	3.5" x 1/2"	24-18412-001, 002	4
R32712	1/3	2/1075	460	1.10	REV	5/370	5.5"	4.7"	6.4" x 1/2"	24-18412-003	2
R43585	1/3	3/1075	115	7.80	REV	7.5/370	5.5"	4.8"	6.0" x 1/2"	024-23210	3
R52775	1/2	1/1050	208/230	4.30	CW	5/370	5.5"	5.1"	9.0" x 1/2" x 9.9"	24-17775-000	5
R22187	1/2	1/1075	208/230	3.90	REV	10/370	5.5"	5.3"	6.0" x 1/2"	024-24110	6
R32400	1/2	1/1075	460	1.80	REV	10/370	5.5"	5.0"	6.0" x 1/2"	024-19691, 18395, 17994	6
S1504	1/2	1/1075	200/230 /460	3.20	REV	7.5/370	5.5"	9.2"	3.5" x 1/2"	24-17994-001, 18412-004	4
R22139	1/2	1/1090	460	1.40	REV	7.5/370	5.5"	4.8"	4.0" x 1/2"	02424110702	7
R22140	1/2	1/1090	230	2.70	REV	7.5/370	5.5"	4.8"	4.0" x 1/2"	02424110701	7
R32512	1/2	1/1100	460	1.50	CCW	5/370	5.5"	8.3"	4.8" x 1/2"	02419512700	8
R32511	1/2	1/1100	208/230	3.50	CW	3/370	5.5"	8.1"	3.7" x 1/2"	02419511700	8

Fig.1



Fig.2



Fig.3

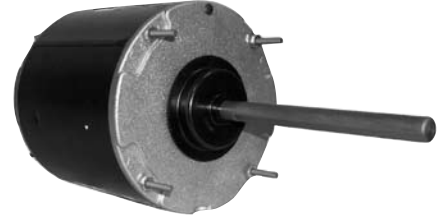

Fig.4



Fig.5



Fig.6

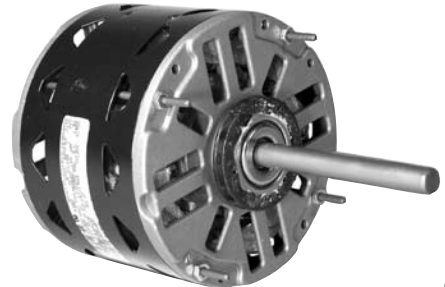

York

Part #	HP	Spd/RPM	Volts	Amps	Rot	Type	Dia	Body	Shaft	Comment	Fig
T2111	1/2	1/3450	575	0.70	REV	3 PH	5.5"	9.0"	2.0"x 5/8" K	24-13776-006, 15447-005	1
R52231	1/2	2/1075	208/230	4.00	REV	P.S.C. 7.5/370	5.5"	7.0"	6.5" x 1/2" x 6.5"	Leece Neville RE128	2
R32716	1/2	2/1075	460	2.00	REV	P.S.C. 10/370	5.5"	5.5"	6.4" x 1/2"	24-18412-006, 19512-000	3
R42404	3/4	1/1075	208/230	5.20	CCW	S.P.	5.5"	6.5"	3.0" x 1/2"	02418404	4
S1510	3/4	1/1075	200/230 /460	4.60	REV	P.S.C. 20/370	5.5"	10.8"	3.5" x 1/2"	Cond. Fan, 1 Phase	5
T2123	3/4	1/3450	575	1.10	REV	3 PH	5.5"	9.5"	2.0"x5/8" K	24-15447-002, 006	1
R43590	3/4	3/1075	208/230	6.30	CW	P.S.C. 10/370	5.5"	5.3"	6.0" x 1/2"	024-18404	6
R42023	1	3/1075	208/230	5.30	REV	P.S.C. 15/370	5.5"	7.3"	5.0" x 1/2"	024-21672C	6
T2138	1 1/2	1/1750	208/230/ 460	4.40	REV	3 PH	6.5"	12.3"	2.0"x5/8" K	24-17671-002, 006	1
T2170	5	1/3450	575	5.00	REV	3 PH	6.5"	12.6"	2.3"x7/8" K	Cond. Fan, 3 Phase	1

110/125 Volt Round			MFD	165 Volt Round			220/250 Volt Round			330 Volt Round				
Part #	Dia.	Hgt.		Part #	Dia.	Hgt.	Part #	Dia.	Hgt.	Part #	Dia.	Hgt.		
35-21A125	1.44"	2.75"	21-25											
35-25A125	1.44"	2.75"	25-30				35-21A250	1.44"	2.75"	35-21B330	1.44"	3.38"		
35-30A125	1.44"	2.75"	30-36				35-25A250	1.44"	2.75"	35-25B330	1.44"	3.38"		
35-36A125	1.44"	2.75"	36-43				35-30A250	1.44"	2.75"	35-30D330	1.81"	3.38"		
35-43A125	1.44"	2.75"	43-56				35-36B250	1.44"	3.38"	35-36D330	1.81"	3.38"		
			43-56				35-43B250	1.44"	3.38"	35-43D330	1.81"	3.38"		
			47-56				35-43F250	2.06"	3.38"					
35-53A125	1.44"	2.75"	53-64				35-47B250	1.44"	3.38"					
			53-64				35-53A250	1.44"	2.75"	35-53D330	1.81"	3.38"		
			56-72				35-53B250	1.44"	3.38"					
			56-72				35-56A250	1.44"	2.75"	35-56D330	1.81"	3.38"		
			59-71				35-56B250	1.44"	3.38"					
35-64A125	1.44"	2.75"	64-77				35-59F250	2.06"	3.38"					
			64-77				35-64A250	1.44"	2.75"					
35-72A125	1.44"	2.75"	72-88			35-72A165	1.44"	2.75"	35-64D250	1.81"	3.38"	35-64D330	1.81"	3.38"
35-88A125	1.44"	2.75"	88-108			35-88A165	1.44"	2.75"	35-72D250	1.81"	3.38"	35-72E330	1.81"	4.38"
			108-130			35-108B165	1.44"	3.38"	35-88D250	1.81"	3.38"	35-88F330	2.06"	3.38"
35-108A125	1.44"	2.75"	108-130					35-108D250	1.81"	3.38"	35-108D330	1.81"	3.38"	
35-124A125	1.44"	2.75"	124-149			35-124B165	1.44"	3.38"			35-108G330	2.06"	4.38"	
35-130A125	1.44"	2.75"	130-156			35-130B165	1.44"	3.38"	35-124D250	1.81"	3.38"	35-124G330	2.06"	4.38"
35-135A125	1.44"	2.75"	135-162					35-130D250	1.81"	3.38"	35-130G330	2.06"	4.38"	
35-145A125	1.44"	2.75"	145-174			35-145B165	1.44"	3.38"	35-145F250	2.06"	3.38"	35-135H330	2.56"	4.38"
35-161A125	1.44"	2.75"	161-193			35-161D165	1.81"	3.38"	35-161D250	1.81"	3.38"	35-145H330	2.56"	4.38"
			161-193					35-161E250	1.81"	4.38"				
			161-193					35-161F250	2.06"	3.38"	35-161H330	2.56"	4.38"	
35-189A125	1.44"	2.75"	189-227			35-189D165	1.81"	3.38"	35-189G250	2.06"	4.38"	35-189G330	2.06"	4.38"
			189-227								35-189H330	2.56"	4.38"	
35-200A125	1.44"	2.75"	200-240											
35-216A125	1.44"	2.75"	216-259			35-216D165	1.81"	3.38"	35-216F250	2.06"	3.38"	35-216H330	2.56"	4.38"
			216-259					35-216G250	2.06"	4.38"				
35-233A125	1.44"	2.75"	233-280			35-233D165	1.81"	3.38"	35-233G250	2.06"	4.38"			
35-243A125	1.44"	2.75"	243-292			35-243D165	1.81"	3.38"	35-243G250	2.06"	4.38"			
35-243B125	1.44"	3.38"	243-292											
35-250A125	1.44"	2.75"	250-300											
35-250F125	2.06"	3.38"	250-300											
35-270A125	1.44"	2.75"	270-324			35-270D165	1.81"	3.38"	35-270G250	2.06"	4.38"			
35-270B125	1.44"	3.38"	270-324											
35-295A125	1.44"	2.75"	295-354											
35-300A125	1.44"	2.75"	300-360											
35-300D125	1.81"	3.38"	300-360											
			320-384											
35-324A125	1.44"	2.75"	324-388											
35-324D125	1.81"	3.38"	324-388											
35-340D125	1.81"	3.38"	340-408			35-340E165	1.81"	4.38"	35-340G250	2.06"	4.38"			
35-378D125	1.81"	3.38"	378-440			35-378E165	1.81"	4.38"	35-378H250	2.56"	4.38"			
35-400B125	1.44"	3.38"	400-480			35-400E165	1.81"	4.38"	35-400H250	2.56"	4.38"			
35-400D125	1.81"	3.38"	400-480											

Components



Continued Next Page

110/125 Volt Round			MFD	165 Volt Round		
Part #	Dia.	Height		Part #	Dia.	Height
35-430D125	1.81"	3.38"	430-515			
35-430F125	2.06"	3.38"	430-516			
35-460D125	1.81"	3.38"	460-552			
35-540D125	1.81"	3.38"	540-648			
35-540E125	1.81"	4.38"	540-648			
35-590D125	1.81"	3.38"	590-708			
35-590E125	1.81"	4.38"	590-708			
35-645E125	1.81"	4.38"	645-774			
35-708E125	1.81"	4.38"	708-850			
35-708F125	2.06"	3.38"	708-850			
35-708G125	2.06"	4.38"	708-850			
35-800D125	1.81"	3.38"	800-960			
35-815D125	1.81"	3.38"	815-978			
35-815E125	1.81"	4.38"	815-978			
35-829E125	1.81"	4.38"	829-995			
35-829G125	2.06"	4.38"	829-995			
35-850G125	2.06"	4.38"	850-1020			
35-1000G125	2.06"	4.38"	1000-1200			
35-1175G125	2.06"	4.38"	1175-1410			
35-1280G125	2.06"	4.38"	1280-1536			
				35-540G165	2.06" 4.38"	
				35-708G165	2.06" 4.38"	
				35-815G165	2.06" 4.38"	
				35-850G165	2.06" 4.38"	
				35-1000G165	2.06" 4.38"	



35-124A125
Illustrated

35-124G330
Illustrated

Capacitor Wiring Diagrams

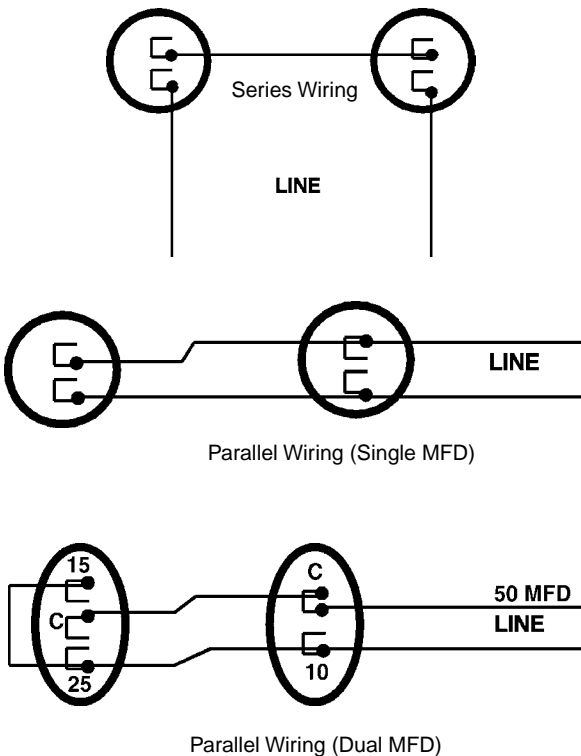

35 - (21) (A) (125)

MFD Range Size Volt

Nomenclature

Size	Dimensions (cm)		Dimensions (")	
	Diameter	Height	Diameter	Height
A	3.66 cm	6.98 cm	1.44"	2.75"
B	3.66 cm	8.58 cm	1.44"	3.38"
C	3.66 cm	11.12 cm	1.44"	4.38"
D	4.60 cm	8.58 cm	1.81"	3.38"
E	4.60 cm	11.12 cm	1.81"	4.38"
F	5.23 cm	8.58 cm	2.06"	3.38"
G	5.23 cm	11.12 cm	2.06"	4.38"
H	5.23 cm	11.12 cm	2.56"	4.38"

NOTE:
CAPACITORS IN SERIES
 • MFD rating decreases; Voltage increases.

$$\text{New MFD Rating} = \frac{\text{MFD}_1 \times \text{MFD}_2}{\text{MFD}_1 + \text{MFD}_2}$$

CAPACITORS IN PARALLEL
 • MFD increases; Voltage rating stays constant.
(ex. two 5 MFD 370 V capacitors wired in parallel is the equivalent of a 10 MFD 370 V Capacitor)

$$\text{New MFD Rating} = \text{MFD}_1 + \text{MFD}_2$$

- When connected in either series or parallel it is recommended that capacitors with the same MFD ratings be used.
- Higher voltages may be substituted for lower voltages in the same MFD rating.

Components

Run Capacitors



Single & Dual Voltage - Oval & Round Capacitors

- Three Styles To Choose From:
 1. Single Voltage / Single MFD
 2. Dual Voltage / Single MFD
 3. Dual Voltage / Dual MFD
- Heavy Duty, Compact Design
- UL & cUL Recognized
- Competitively Priced
- Built In Interrupter
- Largest Selection

**"One Capacitor That's Both 370 & 440 Volt"
"Optimize Your Inventory!"**



Single Voltage 370V • Single MFD

370 Volt Oval						OVAL	MFD
Dimensions (Millimeters)			Dimensions (Inches)				
Width	Depth	Height	Width	Depth	Height		
51.5	31.5	40.0	2.03	1.24	1.58	36-5J370	5
51.5	31.5	60.0	2.03	1.24	2.36	36-7.5J370	7.5
51.5	31.5	70.0	2.03	1.24	2.76	36-10J370	10
51.5	31.5	70.0	2.03	1.24	2.76	36-15K370	15

Dual Voltage 370/440V • Single MFD

370/440 Volt Oval						OVAL	MFD	370/440 Volt Round				
Dimensions (Millimeters)			Dimensions (Inches)					ROUND	Dimensions (Inches)		Dimensions (Millimeters)	
Width	Depth	Height	Width	Depth	Height				Dia.	Height	Dia.	Height
51.5	31.5	40	2.03	1.24	1.58	36-2-370440	2					
51.5	31.5	40	2.03	1.24	1.58	36-3-370440	3	36-3R3744	1.65	1.58	42	40
51.5	31.5	60	2.03	1.24	2.36	36-4-370440	4					
51.5	31.5	60	2.03	1.24	2.36	36-5-370440	5	36-5R3744	1.65	2.37	42	60
51.5	31.5	60	2.03	1.24	2.36	36-6-370440	6	36-6R3744	1.65	2.37	42	60
51.5	31.5	60	2.03	1.24	2.36	36-7-370440	7.5	36-7R3744	1.65	2.37	42	60
51.5	31.5	80	2.03	1.24	3.15	36-10-370440	10	36-10R3744	1.65	2.78	42	70
51.5	31.5	80	2.03	1.24	3.15	36-12-370440	12.5	36-12R3744	1.65	2.78	42	70
51.5	31.5	80	2.03	1.24	3.15	36-15-370440	15	36-15R3744	1.65	3.15	50	80
71.0	45.0	80	2.80	1.77	3.15	36-17-370440	17.5	36-17R3744	1.65	3.15	42	80
71.0	45.0	80	2.80	1.77	3.15	36-20-370440	20	36-20R3744	1.78	3.15	45	80
71.0	45.0	80	2.80	1.77	3.15	36-25-370440	25	36-25R3744	1.78	3.54	50	90
71.0	45.0	90	2.80	1.77	3.55	36-30-370440	30	36-30R3744	2.00	3.94	50	100
71.0	45.0	90	2.80	1.77	3.55	36-35-370440	35	36-35R3744	2.00	3.94	50	100
71.0	45.0	90	2.80	1.77	3.55	36-40-370440	40	36-40R3744	2.00	4.33	50	110
71.0	45.0	110	2.80	1.77	4.33	36-45-370440	45	36-45R3744	2.00	4.33	50	110
71.0	45.0	110	2.80	1.77	4.33	36-50-370440	50	36-50R3744	2.00	4.33	50	110
71.0	45.0	110	2.80	1.77	4.33	36-55-370440	55	36-55R3744	2.17	5.12	55	130
71.0	45.0	130	2.80	1.77	5.12	36-60-370440	60	36-60R3744	2.17	5.12	55	130
Higher Voltage Capacitors Can Be Substituted For Lower Voltage Applications.							70	36-70R3744	2.36	4.72	60	120
							80	36-80R3744	2.36	5.12	60	130
							110	36-110R3744				

Components

Single & Dual Voltage - Oval & Round Capacitors

Dual Voltage 370/440V • Dual MFD

370/440 Volt Oval							MFD	370/440 Volt Round				
Dimensions (Millimeters)			Dimensions (Inches)			OVAL		ROUND	Dimensions (Inches)		Dimensions (Millimeters)	
Width	Depth	Height	Width	Depth	Height				Di.	Height	Di.	Height
71.0	45.0	65	2.80	1.77	2.56	36-10-5-3744	10/5	36-105R3744	1.65	3.15	42	80
71.0	45.0	65	2.80	1.77	2.56	36-15-3-3744	15/3	36-153R3744	1.78	3.15	45	80
71.0	45.0	65	2.80	1.77	2.56	36-15-5-3744	15/5	36-155R3744	1.78	3.15	45	80
71.0	45.0	65	2.80	1.77	2.56	36-15-103744	15/10	36-1510R3744	1.97	3.54	50	90
71.0	45.0	80	2.80	1.77	3.15	36-20-5-3744	20/5	36-205R3744	1.97	3.54	50	90
71.0	45.0	90	2.80	1.77	3.55	36-20-153744	20/15	36-2015R3744	1.97	4.16	50	105
							25/3	36-253R3744	1.97	3.54	50	90
							25/4	36-254R3744	1.97	3.54	50	90
71.0	45.0	80	2.80	1.77	3.15	36-25-5-3744	25/5	36-255R3744	1.97	3.54	50	90
							25/7.5	36-257R3744	1.97	4.16	50	105
71.0	45.0	95	2.80	1.77	3.74	36-25-103744	25/10	36-2510R3744	1.97	4.16	50	105
							30/4	36-304R3744	1.97	4.16	50	105
71.0	45.0	100	2.80	1.77	3.94	36-30-5-3744	30/5	36-305R3744	1.97	4.16	50	105
							35/4	36-354R3744	1.97	4.33	50	110
71.0	45.0	100	2.80	1.77	3.94	36-35-5-3744	35/5	36-355R3744	2.17	4.33	55	110
							35/7.5	36-357R3744	2.17	4.33	55	110
							35/10	36-3510R3744	2.17	4.33	55	110
71.0	45.0	110	2.80	1.77	4.33	36-40-5-3744	40/5	36-405R3744	2.36	4.72	60	120
							40/7.5	36-407R3744	2.36	4.72	60	120
							40/10	36-4010R3744	2.36	4.72	60	120
							45/4	36-454R3744	2.36	4.72	60	120
71.0	45.0	110	2.80	1.77	4.33	36-45-5-3744	45/5	36-455R3744	2.36	4.72	60	120
							45/7.5	36-457R3744	2.36	4.71	60	120
							50/5	36-505R3744	2.36	5.12	60	130
							50/7.5	36-507R3744	2.36	5.12	60	130
							50/10	36-5010R3744	2.36	5.12	60	130
							55/5	36-555R3744	2.36	5.12	60	130
							55/7.5	36-557R3744	2.36	5.12	60	130
							55/10	36-5510R3744	2.36	5.12	60	130
							60/5	36-605R3744	2.36	5.12	60	130
							60/7.5	36-607R3744	2.36	5.12	60	130
							60/10	36-6010R3744	2.36	5.12	60	130
							80/5	36-805R3744	2.36	5.90	60	150



NOTE:
CAPACITORS IN SERIES
 • MFD rating decreases; Voltage increases.

$$\text{New MFD Rating} = \frac{\text{MFD}_1 \times \text{MFD}_2}{\text{MFD}_1 + \text{MFD}_2}$$

CAPACITORS IN PARALLEL
 • MFD increases; Voltage rating stays constant.
(ex. two 5 MFD 370 V capacitors wired in parallel is the equivalent of a 10 MFD 370 V Capacitor)

$$\text{New MFD Rating} = \text{MFD}_1 + \text{MFD}_2$$

• When connected in either series or parallel it is recommended that capacitors with the same MFD ratings be used.
 • Higher voltages may be substituted for lower voltages in the same MFD rating.

Higher Voltage Capacitors Can Be Substituted For Lower Voltage Applications.

Run Capacitor Accessories



36-12204
Illustrated

Part #	Description
36-12204	5.16cm x 3.15cm (2.03" x 1.24") Bracket
36-12205	7.11cm x 4.49cm (2.80" x 1.77") Bracket
36-12206	2.75" x 1.44"



36-12211
Illustrated

Protective Rubber Caps

Part #	Description
36-12210	1 Hole Boot
36-12211	2 Hole Boot
36-12211T	2 Hole Boot - Top
36-12212	3 Hole Boot



36-11205
Illustrated

Wire Leads

Part #	Description
35-11205	15.24cm (6") Wire leads c/w push-on terminals. (10/pk)



35-11206
Illustrated



35-11211
Illustrated

Start Capacitor Accessories

Mounting Brackets

Part #	Description
35-11206	6.9cm (2.75") Bracket
35-11207	8.6cm (3.38") Bracket
35-11208	11.1cm (4.38") Bracket

Protective Plastic End Caps

- On motor end cap leads through bracket.

Part #	Description
35-11210	3.6cm (1 7/16")
35-11211	4.6cm (1 13/16")
35-11212	5.0cm (2 1/16")
35-11213	6.5cm (2 9/16")



35-11216
Illustrated

Protective Plastic End Caps

- On motor end cap top side leads.

Part #	Description
35-11215	3.6cm (1 7/16")
35-11216	4.6cm (1 13/16")
35-11217	5.0cm (2 1/16")
35-11218	6.5cm (2 9/16")



36-11204
Illustrated

Push-On Adaptors

Part #	Description
35-11204	Converts spade terminals to screw. (25/pk)



35-11205
Illustrated

Wire Leads

Part #	Description
35-11205	15.24cm (6") Wire leads c/w push-on terminals. (10/pk)



35-11201
Illustrated

Bleed Resistor

Part #	Description
35-11201	2 Watt, 15,000 OHM, c/w push-on terminals. (10/pk)



35-11204
Illustrated



Push-On Adaptors

Part #	Description
35-11204	Converts spade terminals to screw. (25/pk)



Your Single Source For Quality Motors, Components & Parts

Motor Protection Controls

Part #	Features & Applications	Specifications	Cross Reference
 <p>24-ICM450</p>	<ul style="list-style-type: none"> • Fully Programmable - with LCD diagnostic display. • Easy to configure - simple 7-step push-button setup. • Easy to customize - set points, variables and features are fully adjustable and may be defined by the user while in control SETUP mode. • 25 - fault memory storage, non-volatile. • Independent high and low voltage settings - ideal for dual voltage compressor applications. • Monitors/ identifies front & back side faults. • Reset mode: choice of auto or manual. • Protects against: voltage unbalance, high/ low voltage, phase loss, reversal, faulty power, incorrect sequencing and rapid short cycling. • Reliable, high temperature LCD to 167°F. • Simultaneous voltage display - no scrolling. • Line voltage programmable. • Universal Voltage Operation: 190-630 VAC. 	<ul style="list-style-type: none"> • Voltage: 190-630 VAC. • Frequency: 50/60 Hz. • Voltage Unbalance: adjustable: 2-25%. • Control: 18-240 VAC. • Delay on break timer: (0.1-10 min.). • Output: relay, SPDT N.O.: 10 amps. N.C.: 6 amps. 	<ul style="list-style-type: none"> Diversified • AC-2020 • AC-301 • AC-302 Motorsaver • 455 SSAC • QLM/ QLV Time Mark • 265 Wagner • WPC-800 Watsco • EAC-800 • EAC-8000
 <p>24-ICM400</p>	<ul style="list-style-type: none"> • Lower cost, full performance version featuring bright LED indicators to display system faults. • Monitors "front" and "back" sides of system. • Universal Voltage Operation: 190-630 VAC. • Knob-adjustable features and system set points. • Reset mode: choice of auto or manual lockout. • Built-in anti short-cycle protection. • Protects against: voltage unbalance, high/ low voltage, phase loss, reversal, faulty power, incorrect sequencing and rapid short cycling. • 6.5" x 4.25" x 1.5". 	<ul style="list-style-type: none"> • Voltage: 190-630 VAC. • Frequency: 50/60 Hz. • Voltage Unbalance: adjustable: 2-25%. • Control: 18-240 VAC. • Delay on break timer: (0.1-10 min.). • Output: relay, SPDT N.O.: 10 amps. N.C.: 6 amps. 	<ul style="list-style-type: none"> Diversified • AC-2020 • AC-301 • AC-302 Motorsaver • 455 SSAC • QLM/ QLV Time Mark • 265 Wagner • WPC-800 Watsco • EAC-800 • EAC-8000

24-ICM450 Typical System Diagram

STOP MOTOR BURNOUTS!



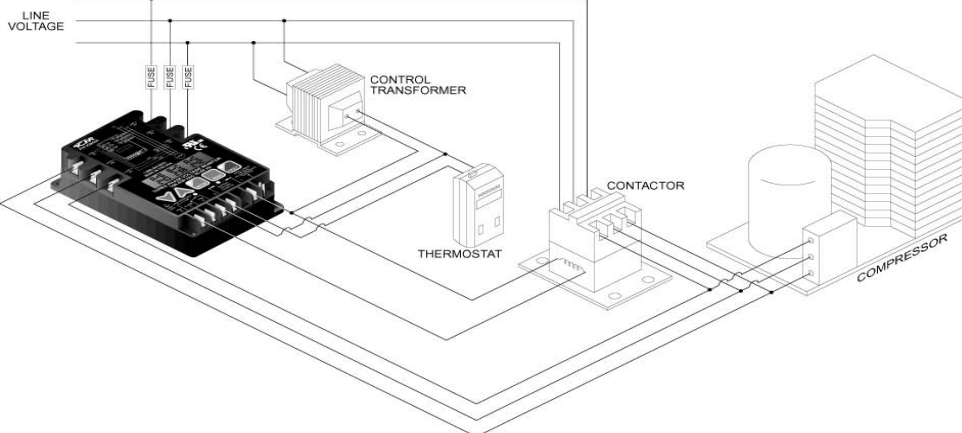

- Monitor voltage unbalance, high/ low voltage, phase loss.



Mode Of Operation

- Voltage Monitors Are Specifically Designed To Protect Compressor Motors And Other 3-Phase Loads From Premature Failure Or Damage Due To Common Voltage Faults. They Offer Complete System Protection By Monitoring Both The Source (Front) And Load (Back) Side Of The System Including The Power, Motor And Contactor Lines. In Addition, An Integral "Delay On Break Timer" Guards Against Rapid Short-Cycling At Both The Control Circuit And The 3-Phase Lines. Compact And Easy To Install, The 24-ICM400 & 24-ICM450 Provide Highly Reliable Protection For Your Valuable Equipment.

Phase Loss & Reversal Protection - Ultra Low Cost



Part #	Features & Applications	Specifications	Cross Reference
 <p>24-ICM401</p>	<ul style="list-style-type: none"> • Low cost 3-phase protection for single side. • Monitors for phase reversal, phase loss, unbalance % as a function of input voltage. • Bright LED indicators for ON and FAULT. • Universal 3-phase input: 190-600 VAC. • Highly reliable passive electronics. • IEEE587 transient-tested. • Epoxy coated for added protection. • Patented: U.S. Patent No. 5,337,206. • 24-ICM401 enclosed model (Open 24-ICM403). • 3.25" x 3" x 1.25". 	<ul style="list-style-type: none"> • Voltage: 190-600 VAC. • Frequency: 50/ 60 Hz. • Control: 18-30 VAC. • Output: relay, SPDT N.O.: 10 amps. 	N/A
 <p>24-ICM402</p>	<ul style="list-style-type: none"> • Low cost 3-phase protection for single side. • Monitors for phase reversal, phase loss, unbalance % as a function of input voltage. • Bright LED indicators for ON and FAULT. • Universal 3-phase input: 190-600 VAC. • Control voltage input: 190-240 VAC. • Highly reliable passive electronics. • IEEE587 transient-tested. • Epoxy coated for added protection. • Patented: U.S. Patent No. 5,337,206. • 24-ICM402 enclosed model (Open 24-ICM404). • 3.25" x 3" x 1.25". 	<ul style="list-style-type: none"> • Voltage: 190-600 VAC. • Frequency: 50/ 60 Hz. • Control: 115 or 208/240 VAC. • Output: relay, SPDT N.O.: 30 amps. 	N/A
 <p>24-ICM408</p>	<ul style="list-style-type: none"> • Reliable 3-phase protection for single side. • Monitors for phase reversal, phase loss, unbalance % and high/ low voltage. • Bright LED indicators for ON and FAULT. • High/ low voltage cut-out: high voltage cut-out set point +12%, low voltage cut-out set point -12%. • Highly reliable passive electronics. • Power/ phase loss detection: within 100ms. • User selectable unbalance voltage: 2 to 8%. • Phase reversal detection: detects on power up. • 8 pin plug-in mount. • 4" x 2.5" x 1.75". 	<ul style="list-style-type: none"> • Voltage: 190-480 VAC. • Frequency: 50/ 60 Hz. • Adjustable DOB: 0.1 to 5 min. • Adjustable DOM: 0.1 to 5 min. • Heavy duty SPDT relay output: NO/ NC - contacts: 10 amps. - resistive @ 250 VAC. 	N/A
 <p>24-ICM409</p>	<ul style="list-style-type: none"> • Reliable 3-phase protection for single side. • Monitors for phase reversal, phase loss, unbalance % and high/ low voltage. • Bright LED indicators for ON and FAULT. • High/ low voltage cut-out: high voltage cut-out set point +12%, low voltage cut-out set point -12%. • Highly reliable passive electronics. • Power/ phase loss detection: within 100ms. • User selectable unbalance voltage: 2 to 8%. • Phase reversal detection: detects on power up. • User selectable delay on make: 0.5 to 5 min. • DIN rail mount. • 4.25" x 3.5" x 2.375". 	<ul style="list-style-type: none"> • Voltage: 190-480 VAC. • Frequency: 50/ 60 Hz. • Adjustable DOB: 0.1 to 5 min. • Adjustable DOM: 0.1 to 5 min. • Heavy duty SPDT relay output: NO/ NC - contacts: 10 amps. - resistive @ 250 VAC. 	NA

Motor Protection Controls

Three Phase Line Voltage Monitors



Part #	Features & Applications	Specifications	Cross Reference																								
 <p>24-ICM441</p>	<ul style="list-style-type: none"> Protects Against: under voltage, over temperature, power interruptions, rapid short cycling, shorted temperature sensor, open temperature sensor. Control Duty, SPST relay layout. 6 amp, 277 VAC relay contacts. Anti-Short-Cycle Time Delay, 4 minute (nominal). 1 second manual bypass. 3.25" x 3" x 1.25". 	<ul style="list-style-type: none"> Voltage: 120 or 208/230 VAC. Frequency: 50/ 60 Hz. Output: relay, SPDT N.O.: 6 amps. 	<table border="0"> <tr> <td>Copeland</td> <td>T.I.</td> </tr> <tr> <td>• 071-0376-01</td> <td>• 15AA1600 B</td> </tr> <tr> <td>• 071-0376-02</td> <td>• 15AA1600 C</td> </tr> <tr> <td>• 071-0397-00</td> <td>• 15AA1603 C</td> </tr> <tr> <td>• 071-0397-01</td> <td>• 31AA1606 E</td> </tr> <tr> <td>• 071-0424-00</td> <td>• 31AA1600 E</td> </tr> <tr> <td>• 071-0424-01</td> <td>Mars</td> </tr> <tr> <td>• 071-9800-00</td> <td>• 37304</td> </tr> <tr> <td>• 071-9800-01</td> <td>• 37306</td> </tr> <tr> <td>Bristol</td> <td>• 37322</td> </tr> <tr> <td>• 241680</td> <td>• 37300</td> </tr> <tr> <td></td> <td>• 37302</td> </tr> </table>	Copeland	T.I.	• 071-0376-01	• 15AA1600 B	• 071-0376-02	• 15AA1600 C	• 071-0397-00	• 15AA1603 C	• 071-0397-01	• 31AA1606 E	• 071-0424-00	• 31AA1600 E	• 071-0424-01	Mars	• 071-9800-00	• 37304	• 071-9800-01	• 37306	Bristol	• 37322	• 241680	• 37300		• 37302
Copeland	T.I.																										
• 071-0376-01	• 15AA1600 B																										
• 071-0376-02	• 15AA1600 C																										
• 071-0397-00	• 15AA1603 C																										
• 071-0397-01	• 31AA1606 E																										
• 071-0424-00	• 31AA1600 E																										
• 071-0424-01	Mars																										
• 071-9800-00	• 37304																										
• 071-9800-01	• 37306																										
Bristol	• 37322																										
• 241680	• 37300																										
	• 37302																										

Single Phase Line Voltage Monitors

Part #	Features & Applications	Specifications	Cross Reference									
 <p>24-ICM491</p>	<ul style="list-style-type: none"> Low cost single phase motor protection. Built-in anti-short cycle protection. Detects high/ low voltage conditions. Helps prevent rapid system recycling. LED indicator: "green" for normal conditions, "red" for fault. Heavy duty SPDT, isolated relay output. Interrogation delay prevents nuisance trips. 3.25" x 3" x 1.25". 	<ul style="list-style-type: none"> Voltage: 95-270 VAC. Output: relay, SPDT N.C./ N.O.: 5 amps. Time Delay Range: adj. 6-600 sec. 	<table border="0"> <tr> <td>Diversified</td> </tr> <tr> <td>• CV-100-RS</td> </tr> <tr> <td>• CV-200-RS15</td> </tr> <tr> <td>• CV-200-RS20</td> </tr> <tr> <td>Watsco</td> </tr> <tr> <td>• EAC-401</td> </tr> <tr> <td>• EAC-402</td> </tr> <tr> <td>• EAC-403</td> </tr> <tr> <td>• EAC-404</td> </tr> </table>	Diversified	• CV-100-RS	• CV-200-RS15	• CV-200-RS20	Watsco	• EAC-401	• EAC-402	• EAC-403	• EAC-404
Diversified												
• CV-100-RS												
• CV-200-RS15												
• CV-200-RS20												
Watsco												
• EAC-401												
• EAC-402												
• EAC-403												
• EAC-404												
 <p>24-ICM515</p>	<ul style="list-style-type: none"> Easy Installation. Low cost, high performance. Weatherproof housing. Rugged, reliable. Protects against: <ul style="list-style-type: none"> Lightning power surges. Voltage surges from air conditioners, generators or motors. 1.75" x 1.62" x 0.75". 	<ul style="list-style-type: none"> Service Voltage: 120/240V single phase. Maximum Surge Current: 24000 amps. Maximum energy dissipation: 200 joules. Installation point: <ul style="list-style-type: none"> Electrical panel. Electrical disconnect. AC protection Modes: line-line, line-ground. 	<p>NA</p>									

Motor Protection Controls

3-Phase Line Voltage Monitors - Plug-in, Single Side Only

Part #	Features & Applications	Specifications	Cross Reference
<p>24-ICM410 24-ICM411 24-ICM412 24-ICM415 24-ICM416 24-ICM417</p> 	<ul style="list-style-type: none"> • Basic low cost, 3-phase motor protection. • Super-quick 100 ms. response time. • Voltage ranges: 200-480 VAC. • 410-412: fixed 8% Voltage Unbalance. • 415-417: adj. 4-8% Voltage Unbalance. • Monitors single side of system for: voltage unbalance, high/ low voltage, phase loss, incorrect sequence, reversal. • LED indicator: green for normal conditions. • Interrogation delay prevents nuisance trips. • Patented: U.S. Patent No. 5,337,206. • 2.5" x 1.75" x 4". 	<ul style="list-style-type: none"> • Line: 200-480 VAC determined by mode. • Control: 18-240 VAC/ VDC. • Frequency: switch selectable 50 or 60 Hz. • Output: relay SPDT, 8 amps resistive. 	<ul style="list-style-type: none"> Diversified • SLA Series • SVA Series
<p>24-ICM420 24-ICM421 24-ICM422 24-ICM425 24-ICM426 24-ICM427</p> 	<ul style="list-style-type: none"> • Same features as Series 24-ICM410-417 plus built-in anti short cycle protection. • Voltage ranges: 200-480 VAC. • 420-422: fixed 8% Voltage Unbalance. • 425-427: adj. 4-8% Voltage Unbalance. • Monitors single side of system for: voltage unbalance, high/ low voltage, phase loss, incorrect sequence, reversal. • LED indicator: green for normal conditions. • Interrogation delay prevents nuisance trips. • Patented: U.S. Patent No. 5,337,206. • 2.5" x 1.75" x 4". 	<ul style="list-style-type: none"> • Voltage: 200-480 VAC determined by model. • Control: 18-240 VAC/ VDC. • Frequency: switch selectable 50 to 60 Hz. • Output: relay SPDT, 8 amps resistive. • ASC timer: range adj. 6-300 sec. 	<ul style="list-style-type: none"> Diversified • AC-410 • AC-411
<p>24-ACS-8</p> 	<ul style="list-style-type: none"> • Relay socket. • 8-pin octal plug-in base. • Locating key ensures proper orientation. • Order ACS-11 for 11-pin base. • For use with 24-ICM410-427, 500-505. • Rated for 480 VAC. 	<ul style="list-style-type: none"> • 10 amps up to 480 VAC. 	<ul style="list-style-type: none"> Diversified • RB-08



Motor Protection Controls - 24-ICM410 to 24-ICM427 Specifications

Part #	24-ICM410-415 Ultra Low Cost Protection	Part #	24-ICM420-427 With Built-in Anti Short-Cycle Protection
24-ICM410	USER-ADJUSTABLE INPUT VOLTAGE: 200 TO 240 VAC. FACTORY FIXED 8% VOLTAGE UNBALANCE.	24-ICM420	USER-ADJUSTABLE INPUT VOLTAGE: 200 TO 240 VAC. FACTORY FIXED 8% VOLTAGE UNBALANCE.
24-ICM411	USER-ADJUSTABLE INPUT VOLTAGE: 360 TO 430 VAC. FACTORY FIXED 8% VOLTAGE UNBALANCE.	24-ICM421	USER-ADJUSTABLE INPUT VOLTAGE: 360 TO 430 VAC. FACTORY FIXED 8% VOLTAGE UNBALANCE.
24-ICM412	USER-ADJUSTABLE INPUT VOLTAGE: 400 TO 480 VAC. FACTORY FIXED 8% VOLTAGE UNBALANCE.	24-ICM422	USER-ADJUSTABLE INPUT VOLTAGE: 400 TO 480 VAC. FACTORY FIXED 8% VOLTAGE UNBALANCE.
24-ICM415	USER-ADJUSTABLE INPUT VOLTAGE: 200 TO 240 VAC. USER-ADJUSTABLE VOLTAGE UNBALANCE: 4% TO 8%.	24-ICM425	USER-ADJUSTABLE INPUT VOLTAGE: 200 TO 240 VAC. USER-ADJUSTABLE VOLTAGE UNBALANCE: 4% TO 8%.
24-ICM416	USER-ADJUSTABLE INPUT VOLTAGE: 360 TO 430 VAC. USER-ADJUSTABLE VOLTAGE UNBALANCE: 4% TO 8%.	24-ICM426	USER-ADJUSTABLE INPUT VOLTAGE: 360 TO 430 VAC. USER-ADJUSTABLE VOLTAGE UNBALANCE: 4% TO 8%.
24-ICM417	USER-ADJUSTABLE INPUT VOLTAGE: 400 TO 480 VAC. USER-ADJUSTABLE VOLTAGE UNBALANCE: 4% TO 8%.	24-ICM427	User-adjustable input voltage: 400 to 480 VAC. User-adjustable voltage unbalance: 4% to 8%.
24-ICM420 TO 24-ICM427 FEATURE AN INTEGRAL, USER-ADJUSTABLE ANTI SHORT-CYCLE TIMER.			

Components

Head Pressure Controls

Dual ON/ OFF Delays Control Fan

Part #	Features & Applications	Specifications	Cross Reference
 <p>24-ICM325H 120-480 VAC</p>	<ul style="list-style-type: none"> • Integral heat pump bypass circuitry allows electronic bypass of speed control. • Eliminates overshoots common to on/ off and pressure switch controls. • Helps prevent evaporator freeze-ups, low pressure cut-outs and liquid-slugged compressors in low ambient conditions. • One model covers 120 to 480 VAC. • Features hard start (adj. 1 to 5 sec.), low speed cut-off (adj.), high temperature bypass, isolated 24 VAC supply. • Controls up to 3 refrigerant circuits. • Typical application: heat pumps. • 4.5" x 3" x 1.75". 	<p>Input</p> <ul style="list-style-type: none"> • Control: 18-30 VAC. • Frequency: 50/ 60 Hz. 1.8 VA max. • Line input: 120-480 VAC. <p>Output</p> <ul style="list-style-type: none"> • Max: 10 amps. • Min: 100 mA. 	<p>One ICM model replaces: Hoffman</p> <ul style="list-style-type: none"> • 800 • 800A • 800AA • 814-50 • 816-10 <p>Ranco</p> <ul style="list-style-type: none"> • E31 Series <p>Johnson Controls</p> <ul style="list-style-type: none"> • P66 • ACT • FM2000
 <p>24-ICM325 120-600 VAC</p>	<ul style="list-style-type: none"> • Eliminates overshoots common to on/ off and pressure switch controls. • One model covers 120 to 600 VAC. • Features hard start, low temperature bypass, isolated 24 VAC supply. • Controls one refrigerant circuit. • Typical application: refrigeration and A/C. • 4.5" x 3" x 1.75". <p>Accessories:</p> <ul style="list-style-type: none"> • 24-ICM375 probe, 50° to 80°F (10° to 27°C). • 24-ICM376 probe, 70° to 100°F (21° to 38°C). • 24-ICM377 probe, 95 to 120°F (35° to 49°C). 	<p>Input</p> <ul style="list-style-type: none"> • Control: 18-30 VAC. • Frequency: 50/ 60 Hz. • Line input: 120-600 VAC. <p>Output</p> <ul style="list-style-type: none"> • Max: 10 amps. • Min: 100 mA. 	N/A
 <p>24-ICM326H 120 OR 208/ 240 VAC 24-ICM327H 480 VAC</p>	<ul style="list-style-type: none"> • Built-in transformer eliminates cost, reduces installation time and simplifies wiring. • Helps prevent evaporator freeze-ups, low pressure cut-outs and liquid-slugged compressors in low ambient conditions. • Features hard start, low temperature cut-off, high temperature bypass. • 4.5" x 3" x 2". • Typical application: ideal for heat pumps, line voltage air conditioning and refrigeration. 	<p>24-ICM326H</p> <ul style="list-style-type: none"> • Control: 120 or 208/ 240 VAC. <p>24-ICM327H</p> <ul style="list-style-type: none"> • Control: 480 VAC. • Frequency: 50/ 60 Hz. <p>Output current:</p> <ul style="list-style-type: none"> • Max: 10 amps. • Min: 100 mA. 	<p>Hoffman</p> <ul style="list-style-type: none"> • 800 • 800A • 800AA • 814-50 • 816-10 <p>Ranco</p> <ul style="list-style-type: none"> • E31 Series <p>Johnson Controls</p> <ul style="list-style-type: none"> • P66

24-ICM326H Typical System Diagram

Applications

- Ideal For Low Ambient Conditions.
- Found In Supermarkets, Frozen Food Storage, Computer Rooms, Cooling Tower Fans, Temperature/ Humidity-sensitive Environments.

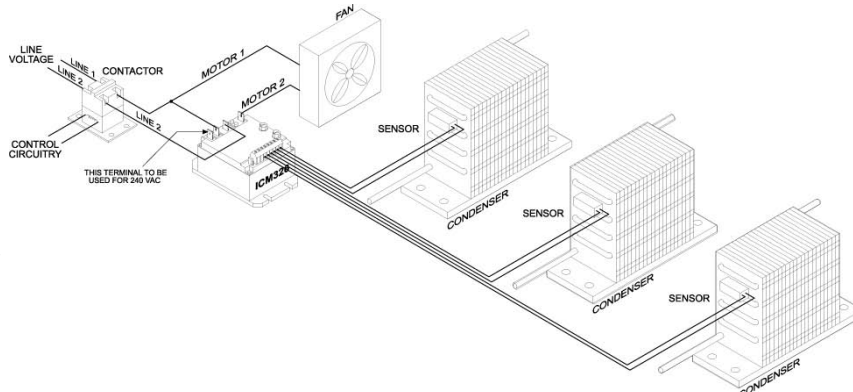

Mode Of Operation

- Head pressure controls operate as temperature-sensitive motor fan speed controls. Head pressure is regulated during low ambient conditions by varying the amount of airflow through the condenser. This helps ensure sufficient pressure across the expansion valve, preventing costly down time and or loss of valuable perishable goods.



3-Phase Head Pressure Controls

With LCD Diagnostics - Designed for 3-Phase Systems

Part #	Features & Applications	Specifications	Cross Reference
 <p>24-ICM336 208/ 240 VAC</p> <p>24-ICM337 460 VAC</p>	<ul style="list-style-type: none"> • Specifically designed for 3-phase systems. • Easy LCD programming and diagnostics. • Helps prevent evaporator freeze-ups, low pressure cutouts & liquid slugged compressors in low ambient conditions. • Controls head pressure by varying the amount of airflow through the condenser. • Low temp cut-off & high temp set points. • Temperature, pressure, milliamps, or DC voltage input. • True sine wave output. • Modulates voltage and frequency. 	<p>24-ICM336</p> <ul style="list-style-type: none"> • Control: 208-240 VAC 1 to 3 HP. <p>24-ICM337</p> <ul style="list-style-type: none"> • Control: 480 VAC 1 to 5 HP. 	<ul style="list-style-type: none"> • Motormaster III • Hoffmann

Head Pressure Control Accessories

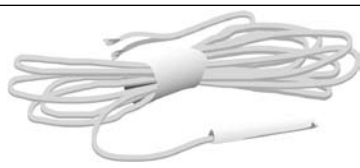
Sensor Probes

Part #	Features & Applications
 <p>24-ICM375 24-ICM376 24-ICM377</p>	<ul style="list-style-type: none"> • Probes for use with 24-ICM325, 24-ICM326, and 24-ICM327 head pressure controls. • Sensor probes, choose from (3) temperature ranges. • 24-ICM375: 50° to 80°F (10° to 27°C). • 24-ICM376: 70° to 100°F (21° to 38°C). • 24-ICM377: 95 to 120°F (35° to 49°C).
 <p>24-ICM379</p>	<ul style="list-style-type: none"> • Probe for use with 24-ICM325H, 24-ICM326H, and 24-ICM327H head pressure controls with optional heat pump bypass features.
 <p>24-ICM380</p>	<ul style="list-style-type: none"> • Optional pressure transducer for 24-ICM336 & 24-ICM337 three-phase head pressure controls.



Outdoor Enclosure

Part #	Features & Applications
 <p>24-ACCOE01</p>	<ul style="list-style-type: none"> • It's worth protecting the controls that protect your equipment! • Rugged Steel Construction. • Easy to mount. • Protects controls from harsh environmental conditions such as temperature, shock, humidity and vibration.

RapidStart® Motor Starters

Current Sensing

By monitoring the compressor "current" upon start-up, RapidStart® is able to engage the hard start capacitor for precisely the correct amount of time, ensuring maximum starting torque without the risk of supplying too much current into the start winding. A timed safety circuit is provided in the event the motor fails to start within 2 seconds. Current sensing hard start precisely increases starting torque.

Part #	Features & Applications	Specifications	Cross Reference
24-ICM803 	<ul style="list-style-type: none"> Operates from 95 to 288 VAC. Max input voltage: 502 VAC. Patented current sensing circuitry. Self-adjusting to voltage fluctuation. Easy to install, 2 wires. OEM approved. Solid-state circuitry. Boosts starting torque. Disengages upon start. 	<ul style="list-style-type: none"> Ideally suited for 1/2 thru 3 Hp. 88 to 106 Mfd. capacitor. 	Supco • SPP-8 Kickstart • TO5 • TO-5
24-ICM805 	<ul style="list-style-type: none"> Operates from 95 to 288 VAC. Max input voltage: 502 VAC. Patented current sensing circuitry. Self-adjusting to voltage fluctuation. Easy to install, 2 wires. OEM approved. Solid-state circuitry. Boosts starting torque. Disengages upon start. 	<ul style="list-style-type: none"> Ideally suited for 3 thru 5 Hp. 145 to 175 Mfd. capacitor. 	Kickstart • KS1
24-ICM810 	<ul style="list-style-type: none"> Operates from 95 to 288 VAC. Max input voltage: 502 VAC. Patented current sensing circuitry. Self-adjusting to voltage fluctuation. Easy to install, 2 wires. OEM approved. Solid-state circuitry. Boosts starting torque. Disengages upon start. 	<ul style="list-style-type: none"> Ideally suited for 5 thru 10 Hp. 243 to 292 Mfd. capacitor. 	N/A

Wiring & System Diagrams

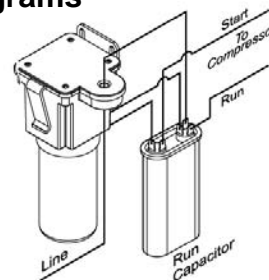
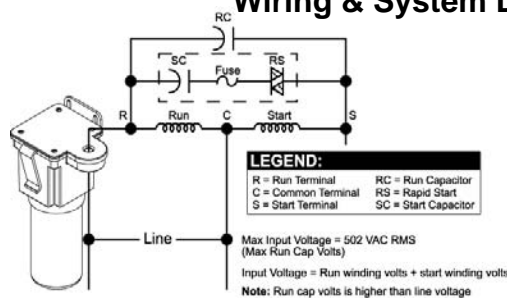

Alternate Wiring Configurations

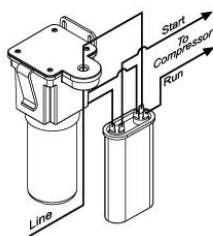

PSC Units

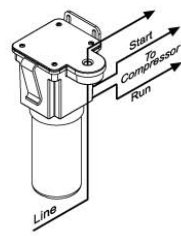

Capacitor Start Induction Run

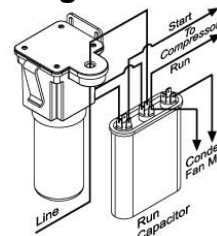

Double Capacitor

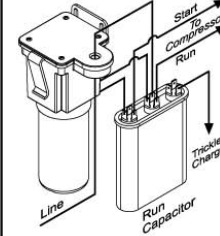



Off Cycle Heat

RapidStart® Motor Starters

Voltage Sensing

ICM's differential voltage sensing products employ patented circuitry which monitors differential compressor auxiliary voltage, determines the state of the motor and precisely engages and disengages the start capacitor. A timed safety circuit is provided in the event the motor fails to start within 2 seconds.

Part #	Features & Applications	Specifications	Cross Reference
24-ICM850 	<ul style="list-style-type: none"> Increases starting torque up to 500%. Ensures precise starts. Reduces inventory. Not affected by ambient temperature. Recycles instantly (less than one second). Multi-voltage operation... either 115 or 240 VAC motors. 	<ul style="list-style-type: none"> Voltage: 90 to 277 VAC. Max input voltage: 390 VAC. Range: 1/12 to 10 Hp. Recommended range: 1/12 to 1 Hp. Oper. Temp. Range: 40°C to +65°C 43 to 52 Mfd 330 V Capacitor. 	N/A
24-ICM860 	<ul style="list-style-type: none"> Increases starting torque up to 500%. Ensures precise starts. Reduces inventory. Not affected by ambient temperature. Recycles instantly (less than one second). Multi-voltage operation... either 115 or 240 VAC motors. 	<ul style="list-style-type: none"> Voltage: 90 to 277 VAC. Max input voltage: 390 VAC. Range: 2 to 5 Hp. Oper. Temp. Range: -40°C to +65°C 88 to 106 Mfd 330 V Capacitor. 	N/A

Wiring & System Diagrams

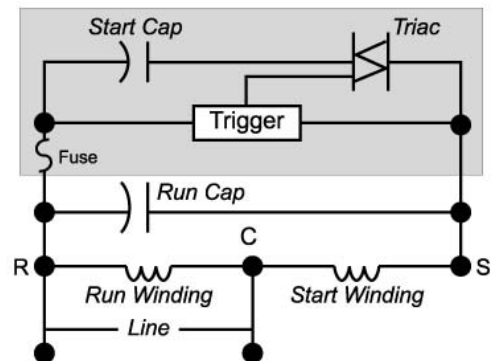
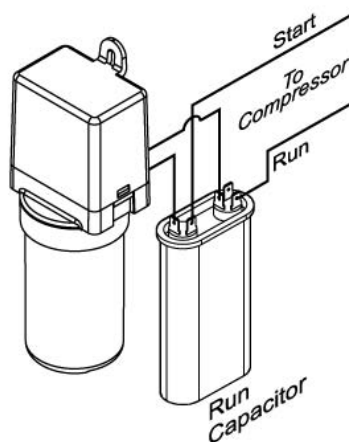

Max Input Voltage = 390 VAC RMS
 (Max Run Cap Volts)
 Input voltage = Run winding volts + start winding volts

Note: Run cap volts is higher than line voltage

RapidStart® Features

- SELF ADJUSTING
- USES CURRENT DIFFERENTIAL TECHNOLOGY
- DOES NOT USE POTENTIAL MOTOR START RELAY
- TWO WIRES, NON-POLARIZED
- RECYCLES INSTANTLY
- SENSES WHETHER MOTOR STARTED OR NOT
- REPLACES 3-WIRE RELAY & CAPACITOR KIT
- UL & CSA RECOGNIZED
- APPROVED BY COMPRESSOR & EQUIPMENT MANUFACTURERS
- USED BY OEM MANUFACTURERS
- SAFETY CUT-OFF
- TRUE POWER FACTOR STARTING NOT REQUIRED
- NOT FACTORY CALIBRATED
- NOT VOLTAGE SENSITIVE
- DOES NOT REQUIRE PTCR DEVICE
- NO TIMING CIRCUIT DEVICE
- NOT AFFECTED BY AMBIENT TEMPERATURE

RapidStart® Applications

- Water Coolers
- Vending Machines
- Household Refrigerators (115 or 230 VAC)
- Commercial Refrigerators (115 or 230 VAC)
- Air Conditioners
- Heat Pumps

Definite Purpose Magnetic Contactors

Rotom Definite Purpose Magnetic Contactors

Contactors are designed to establish or interrupt a power circuit. Definite purpose contactors unlike general purpose contactors are non-rebuildable electronic controls designed for specific application with clearly defined operating conditions.

FEATURES:

- Compact size.
- Quieter than traditional designs.
- Far more efficient operation.
- Universal electrical connections.
- Quick connect terminals.
- Universal galvanized mounting plates.
- Protective Dust arc cover
- Snap on auxiliary contacts.
- Individually packaged.
- Easy to understand part numbers.
- Complete cross reference.
- UL, CE & cUL approved.
- Price competitive.

Typical Applications

- Heating
- Ventilation
- Air Conditioning
- Refrigeration
 - Compressors
 - Motors
- Agriculture
- Pool & Spa Controls
- Food Service Equipment
- Welding Equipment
- Business Machines

Contactor Nomenclature

HC - 1 30 24
HC = Product Code
1 = Poles (1, 2, 3 or 4)
30 = Full Load Amps. (30A, 40A...)
24 = Coil Voltage (24, 120 or 240)

Contactor Terminal Types

- **30 Amp.** = #10-32 Combination Screw Terminals
 - **40, 50 & 60 Amp.** = # 14-4 Compression Lug Terminals with 1/4"-20 Screws
- Custom Terminal Type Models Available Upon Request!*



HC-13024
1 Pole Contactor With Shunt Illustrated

One Pole Contactors

- One pole contactor with shunt
- UL cUL CE Approved
- 4 - 1/4" Brass Spade Terminals Per Power Connection
- #10-32 Combination Screw Terminals
- 50/ 60 Hz

Part #	Full Load Amps.	Coil Voltage 50/60	Resistive Amps.	Locked Rotor Amps.@240V	Height	Width	Depth
HC-13024	30	24	40	180	2.38"	2.00"	3.29"
HC-130120	30	120	40	180	2.38"	2.00"	3.29"
HC-130240	30	208/240	40	180	2.38"	2.00"	3.29"



HC-23024
2 Pole Contactor Illustrated

Two Pole Contactors

- UL cUL CE Approved
- 30 Amp.= 4 - 1/4" Brass Spade Terminals Per Power Connection
- 40 Amp.= 4 - 1/4" Copper Spade Terminals Per Power Connection
- 50/ 60 Hz
- Dust/Arc Cover Over Contacts (40 Amp Models & Up)

Part #	Full Load Amps.	Coil Voltage 50/60	Resistive Amps.	Locked Rotor Amps.@240V	Height	Width	Depth
HC-23024	30	24	40	180	2.45"	2.06"	3.32"
HC-230120	30	120	40	180	2.45"	2.06"	3.32"
HC-230240	30	208/240	40	180	2.45"	2.06"	3.32"
HC-24024	40	24	50	240	2.63"	2.06"	3.32"
HC-240120	40	120	50	240	2.63"	2.06"	3.32"
HC-240240	40	208/240	50	240	2.63"	2.06"	3.32"

Definite Purpose Magnetic Contactors



HC-33024
3 Pole Contactor Illustrated

Three Pole Contactors

- UL, CSA, (CE 30 - 60 Amp)
- 30 Amp.= 2 - 1/4" Brass Spade Terminals Per Power Connection
- 40 Amp.= 2 - 1/4" Copper Spade Terminals Per Power Connection
- 50 - 90 Amp.= 2 - 1/4" Copper Spade Terminals & Aluminum Lug Per Power Connection
- 50/ 60 Hz
- Contact Cover Over Contacts (30 - 40 Amp Feature Built-In Test Button)

Part #	Full Load Amps.	Coil Voltage 50/60	Resistive Amps.	Locked Rotor Amps.@240V	Height	Width	Depth
HC-33024	30	24	40	180	2.99"	2.37"	3.75"
HC-330120	30	120	40	180	2.99"	2.37"	3.75"
HC-330240	30	208/240	40	180	2.99"	2.37"	3.75"
HC-34024	40	24	50	240	2.99"	2.37"	3.75"
HC-340120	40	120	50	240	2.99"	2.37"	3.75"
HC-340240	40	208/240	50	240	2.99"	2.37"	3.75"
HC-35024	50	24	65	300	3.62"	2.75"	4.00"
HC-350120	50	120	65	300	3.62"	2.75"	4.00"
HC-350240	50	208/240	65	300	3.62"	2.75"	4.00"
HC-36024	60	24	75	360	3.62"	2.75"	4.00"
HC-360120	60	120	75	360	3.62"	2.75"	4.00"
HC-360240	60	208/240	75	360	3.62"	2.75"	4.00"
HC-37524	75	24	90	450	4.05"	3.75"	5.18"
HC-375120	75	120	90	450	4.05"	3.75"	5.18"
HC-375240	75	208/240	90	450	4.05"	3.75"	5.18"
HC-39024	90	24	120	540	4.05"	3.75"	5.18"
HC-390120	90	120	120	540	4.05"	3.75"	5.18"
HC-390240	90	208/240	120	540	4.05"	3.75"	5.18"



HC-44024
4 Pole Contactor Illustrated

Four Pole Contactors

- UL, CSA, CE Approved
- 30 Amp.= 2 - 1/4" Brass Spade Terminals Per Power Connection
- 40 Amp.= 2 - 1/4" Copper Spade Terminals Per Power Connection
- 50/ 60 Hz
- Contact Cover Over Contacts With Built-In Test Button

Part #	Full Load Amps.	Coil Voltage 50/60	Resistive Amps.	Locked Rotor Amps.@240V	Height	Width	Depth
HC-43024	30	24	40	180	2.99"	2.75"	3.75"
HC-430120	30	120	40	180	2.99"	2.75"	3.75"
HC-430240	30	208/240	40	180	2.99"	2.75"	3.75"
HC-44024	40	24	50	240	2.99"	2.75"	3.75"
HC-440120	40	120	50	240	2.99"	2.75"	3.75"
HC-440240	40	208/240	50	240	2.99"	2.75"	3.75"

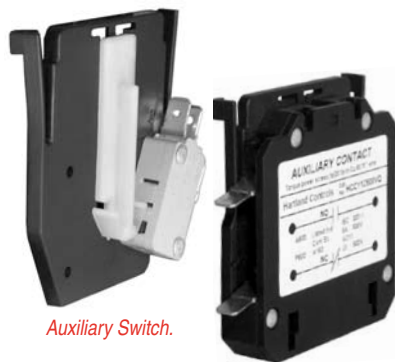

Auxiliary Switch.

HC-250 (One Switch)

HC-500 (Two Switches)

Auxiliary Switch.

HC-600

Auxiliary Contact Switches

- Clips Directly Onto Either End Of Any 3 or 4 Pole Rotom Contactor
- 1/4" Quick Connect Terminals
- Snap Fast Action Switch

Part #	Continuous Amps.	Voltage Rating	Description	Height	Width	Depth
HC-250	10	300	1 x SPDT, N.O. & N.C.	2.81"	2.61"	0.67"
HC-500	10	300	2 x SPDT, N.O. & N.C.	2.81"	2.61"	0.67"
HC-600*	10	600	2 Contacts x 1 Pole, N.O (make) or N.C. (break)	2.77"	3.13"	0.70"

* 6-32 Screw Terminal Model Available - Order Part # **HC-600S**

Definite Purpose Magnetic Contactors - Cross Reference

Poles	Amps	Volts	Arrow Hart	Cutler Hammer	Fasco	Fasco New	Furnas	Furnas Centu- rion	GE 353 Series	GE 453 Series	Rotom
1	25	24	C251U10	C25ANB125T	1S25A	-	-	-	CR353CB1AH1	-	HC-13024
		120	C251U20	C25ANB125A	1S25B	-	-	-	CR353CB1AA1	-	HC-130120
		208/240	C251U30	C25ANB125B	1S25C	-	-	-	CR353CB1AB1	-	HC130240
1	30	24	C301U10	C25ANB130T	1S30A	C1S30A	-	-	CR353CC1AH1	-	HC-13024
		120	C301U20	C25ANB130A	1S30B	C1S30B	-	-	CR353CC1AA1	-	HC-130120
		208/240	C301U30	C25ANB130B	1S30C	C1S30C	-	-	CR353CC1AB1	-	HC-130240
1	40	24	-	C25ANB140T	-	C1S40A	-	-	CR353CD1AH1	-	HC-24024
		120	-	C25ANB140A	-	C1S40B	-	-	CR353CD1AA1	-	HC-240120
		208/240	-	C25ANB140B	-	C1S40C	-	-	CR353CD1AB1	-	HC-240240
1.5	25	24	C251NU10	C25CNB125T	-	-	45DD10AJLL2	45DG10AJD8A	CE353CB3AH1	CR453CB3HAA	HC-23024
		120	C251NU20	C25CNB125A	-	-	45DD10AFLL2	45DG10AFD8A	CR353CB3AA1	CR453CB3AAA	HC-230120
		208/240	C251NU30	C25CNB125B	-	-	45DD10AGLL2	45DG10AGD8A	CR353CB3AB1	CR453CB3BAA	HC-230240
1.5	30	24	C301NU10	C25CNB130T	-	-	45ED10AJLL2	45EG10AJA	CR353CC3AH1	CR453CC3HAA	HC-23024
		120	C301NU20	C25CNB130A	-	-	45ED10AFLL2	45EG10AFA	CR353CC3AA1	CR453CC3AAA	HC-230120
		208/240	C301NU30	C25CNB130B	-	-	45ED10AGLL2	45EG10AGA	CR353CC3AB1	CR453CC3BAA	HC-230240
1.5	40	24	-	C25CNB140T	-	-	45GD10AJ	45GG10AJA	CR353CD3AH1	CR453CD3HAA	HC-24024
		120	-	C25CNB140A	-	-	45GD10AF	45GG10AFA	CR353CD3AA1	CR453CD3AAA	HC-240120
		208/240	-	C25CNB140B	-	-	45GD10AG	45GG10AGA	CR353CD3AB1	CR453CD3BAA	HC-240240
2	20	24	C202U10	C25BNB220T	2S20A	-	45CA20AJ	45CG20AJ	CR353CA2AH1	CR453CA2HAA	H2-23024
		120	C202U20	C25BNB220A	2S20B	-	45CA20AF	45CG20AF	CR353CA2AA1	CR453CA2AAA	HC-230120
		208/240	C202U30	C25BNB220B	2S20C	-	45CA20AG	45CG20AG	CR353CA2AB1	CR453CA2BAA	HC-230240
2	25	24	C252U10	C25BNB225T	2S25A	-	45DA20AJ	45DG20AJ	CR353CB2AH1	CR453CB2HAA	H2-23024
		120	C252U20	C25BNB225A	2S25B	-	45DA20AF	45DG20AF	CR353CB2AA1	CR453CB2AAA	HC-230120
		208/240	C252U30	C25BNB225B	2S25C	-	45DA20AG	45DG20AG	CR353CB2AB1	CR453CB2BAA	HC-230240
2	25	24	ACC220U10	C25DND225T	-	-	41NB20AJM	42AF15AJ	CR353AB2AH1	-	HC-23024
		120	ACC220U20	C25DND225A	-	-	41NB20AFM	42AF15AF	CR353AB2AA1	-	HC-230120
		208/240	ACC220U30	C25DND225B	-	-	41NB20AGM	42AF15AG	CR353AB2AB1	-	HC-230240
2	30	24	C302U10	C25BNB230T	2S30A	C2S30A	45EA20AJ	45EG20AJ	CR353CC2AH1	CR453CC2HAA	H2-23024
		120	C302U20	C25BNB230A	2S30B	C2S30B	45EA20AF	45EG20AF	CR353CC2AA1	CR453CC2AAA	HC-230120
		208/240	C302U30	C25BNB230B	2S30C	C2S30C	45EA20AG	45EG20AG	CR353CC2AB1	CR453CC2BAA	HC-230240
2	30	24	ACC320U10	C25DND230T	-	-	42BE15AJ106	42BF15AJ	CR353AC2AH1	-	HC-23024
		120	ACC320U20	C25DND230A	-	-	42BE15AF106	42BF15AF	CR353AC2AA1	-	HC-230120
		208/240	ACC320U30	C25DND230B	-	-	42BE15AG106	42BF15AG	CR353AC2AB1	-	HC-230240
2	40	24	C402U10	C25BNB240T	2M40A	C2S40A	45GA20AJ	45GG20AJ	CR353CE2BH1	CR453CE2HBB	HC-24024
		120	C402U20	C25BNB240A	2M40B	C2S40B	45GA20AF	45GG20AF	CR353CE2BA1	CR453CE2ABB	HC-240120
		208/240	C402U30	C25BNB240B	2M40C	C2S40C	45GA20AG	45GG20AG	CR353CE2BB1	CR453CE2BBB	HC-240240
2	40	24	ACC420U10	C25DNF240T	-	-	42CE15AJ106	42CF15AJ	CR353AD2AH1	-	HC-24024
		120	ACC420U20	C25DNF240A	-	-	42CE15AF106	42CF15AF	CR353AD2AA1	-	HC240120
		208/240	ACC420U30	C25DNF240B	-	-	42CE15AG106	42CF15AG	CR353AD2AB1	-	HC-240240
2	50	24	ACC520U10	C25FNF250T	-	-	42DE15AJ106	42DF15AJ	CR353FE2BH1	-	HC-35024
		120	ACC520U20	C25FNF250A	-	-	42DE15AF106	42DF15AF	CR353FE2BA1	-	HC-350120
		208/240	ACC520U30	C25FNF250B	-	-	42DE15AG106	42DF15AG	CR353FE2BB1	-	HC-350240
2	60	24	ACC620U10	C25FNF260T	-	-	42EE15AJ106	42EF15AJ	CR353FF2BH1	-	HC-36024
		120	ACC620U20	C25FNF260A	-	-	42EE15AF106	42EF15AF	CR353FF2BA1	-	HC-360120
		208/240	ACC620U30	C25FNF260B	-	-	42EE15AG106	42EF15AG	CR353FF2BB1	-	HC-360240
3	25	24	ACC230U10	C25DND325T	3M25A	-	41NB30AJM	42AF35AJ	CR353AB3AH1	CR453AB3HAA	HC-33024
		120	ACC230U20	C25DND325A	3M25B	-	41NB30AFM	42AF35AF	CR353AB3AA1	CR453AB3AAA	HC-330120
		208/240	ACC230U30	C25DND325B	3M25C	-	41NB30AGM	42AF35AG	CR353AB3AB1	CR453AB3BAA	HC-330240
3	30	24	ACC330U10	C25DND330T	3M30A	C3M30A	42BE35AJ106	42BF35AJ	CR353AC3AH1	CR453AC3HAA	HC-33024
		120	ACC330U20	C25DND330A	3M30B	C3M30B	42BE35AF106	42BF35AF	CR353AC3AA1	CR453AC3AAA	HC-330120
		208/240	ACC330U30	C25DND330B	3M30C	C3M30C	42BE35AG106	42BF35AG	CR353AC3AB1	CR453AC3BAA	HC-330240
3	40	24	ACC430U10	C25DNF340T	3M40A	C3M40A	42CE35AJ106	42CF35AJ	CR353AD3BH1	CR453AD3HBB	HC-34024
		120	ACC430U20	C25DNF340A	3M40B	C3M40B	42CE35AF106	42CF35AF	CR353AD3BA1	CR453AD3ABB	HC-340120
		208/240	ACC430U30	C25DNF340B	3M40C	C3M40C	42CE35AG106	42CF35AG	CR353AD3BB1	CR453AD3BBB	HC-340240
3	50	24	ACC530U10	C25FNF350T	3L50A	C3L50A	42DE35AJ106	42DF35AJ	CR353FE3BH1	-	HC-35024
		120	ACC530U20	C25FNF350A	3L50B	C3L50B	42DE35AF106	42DF35AF	CR353FE3BA1	-	HC-350120
		208/240	ACC530U30	C25FNF350B	3L50C	C3L50C	42DE35AG106	42DF35AG	CR353FE3BB1	-	HC-350240
3	60	24	ACC630U10	C25FNF360T	3L60A	C3L60A	42EE35AJ106	42EF35AJ	CR353FF3BH1	-	HC-36024
		120	ACC630U20	C25FNF360A	3L60B	C3L60B	42EE35AF106	42EF35AF	CR353FF3BA1	-	HC-360120
		208/240	ACC630U30	C25FNF360B	3L60C	C3L60C	42EE35AG106	42EF35AG	CR353FF3BB1	-	HC-360240
4	25	24	-	C25END425T	-	-	42AF25AJ	42AF25AJ	CR353AB4AH1	-	HC-43024
		120	-	C25END425A	-	-	42AF25AF	42AF25AF	CR353AB4AA1	-	HC-430120
		208/240	-	C25END425B	-	-	42AF25AG	42AF25AG	CR353AB4AB1	-	HC-430240
4	30	24	ACC34U10	C25END430T	-	C4L30A	42BE25AJ106	42BF25AJ	CR353AC4AH1	-	HC-43024
		120	ACC34U20	C25END430A	-	C4L30B	42BE25AF106	42BF25AF	CR353AC4AA1	-	HC-430120
		208/240	ACC34U30	C25END430B	-	C4L30C	42BE25AG106	42BF25AG	CR353AC4AB1	-	HC-430240
4	40	24	ACC440U10	C25ENF440T	-	C4L40A	42CE25AJ106	42CF25AJ	CR353AD4BH1	-	HC-44024
		120	ACC440U20	C25ENF440A	-	C4L40B	42CE25AF106	42CF25AF	CR353AD4BA1	-	HC-440120
		208/240	ACC440U30	C25ENF440B	-	C4L40C	42CE25AG106	42CF25AG	CR353AD4BB1	-	HC-440240

Contactor Nomenclature • HC - 1 30 24

HC = Product Code • 1 = Poles (1, 2, 3 or 4) • 30 = Full Load Amps. (30A, 40A...) • 24 = Coil Voltage (24, 120 or 240)

Definite Purpose Magnetic Contactors - Cross Reference

Poles	Amps	Volts	Honeywell	Honeywell Economy	Honeywell Obsolete	Joslyn Clark	Mars	Mars Private	Products Unlimited	Square D	WR Stevco	Rotom		
1	25	24	DP1025A5005	-	R824A1289	A77306652A3	-	60010	-	3100Y10Q1350	-	94-385	HC-13024	
		120	DP1025B5046	-	R4242A1148	A77306652A1	-	60011	-	3100Y10T1350	-	94-386	HC-130120	
		208/240	DP1025C5045	-	R4242A1155	A77306652A2	-	60012	-	3100Y10U1350	-	94-387	HC130240	
1	30	24	DP1030A5013	-	R8243A1361	A77306651A3	-	60025	91101	3100Y10Q2350	-	94-388	HC-13024	
		120	DP103085020	-	R4243A1139	A77306651A1	-	60026	91102	3100Y10T2350	-	94-389	HC-130120	
		208/240	DP1030C5029	-	R4243A1147	A77306651A2	-	60027	91103	3100Y10U2350	-	94-390	HC-130240	
1	40	24	DP1040A5004	-	-	-	-	-	91301	3100Y10Q19350	-	94-394	HC-24024	
		120	DP1040B5003	-	-	-	-	-	91302	3100Y10T19350	-	94-395	HC-240120	
		208/240	DP1040C5002	-	-	-	-	-	91303	3100Y10U19350	-	94-396	HC-240240	
1.5	25	24	-	-	-	A77306654A3	-	-	-	3100Y15Q1350	8910DP21V14	-	HC-23024	
		120	-	-	-	A77306654A1	-	-	-	3100Y15T1350	8910DP21V02	-	HC-230120	
		208/240	-	-	-	A77306654A2	-	-	-	3100Y15U1350	8910DP21V09	-	HC-230240	
1.5	30	24	-	-	-	A77306653A3	-	-	91111	3100Y15Q2350	8910DP31V14	-	HC-23024	
		120	-	-	-	A77306653A1	-	-	91112	3100Y15T2350	8910DP31V02	-	HC-230120	
		208/240	-	-	-	A77306653A2	-	-	91113	3100Y15Y2350	8910DP31V09	-	HC-230240	
1.5	40	24	-	-	-	-	-	-	91311	3100Y15Q19350	-	-	HC-24024	
		120	-	-	-	-	-	-	91312	3100Y15T19350	-	-	HC-240120	
		208/240	-	-	-	-	-	-	91313	3100Y15U19350	-	-	HC-240240	
2	20	24	DP2020A5021	-	R8242B1006	A77306680A3	-	60000	91121	3100Y20Q3350CL	8910DP12V14	-	H2-23024	
		120	DP2020B5038	-	R4242B1005	A77306680A1	14122	60001	91122	3100Y20T3350CL	8910DP12V02	-	HC-230120	
		208/240	DP2020C5037	-	R4242B1013	A77306680A2	14123	60002	91123	3100Y20U3350CL	8910DP12V09	-	HC-230240	
2	25	24	-	-	-	A77306660A3	-	-	60015	91221	3100Y20Q5350CL	8910DP22V14	-	H2-23024
		120	-	-	-	A77306660A1	14222	60016	91222	3100Y20T5350CL	8910DP22V02	-	HC-230120	
		208/240	-	-	-	A77306660A2	-	60017	91223	3100Y20U5350CL	8910DP22V09	-	HC-230240	
2	25	24	-	-	-	A77309039A3	13083	60110	-	3100Y20Q8350	8910DPA22V14	-	HC-23024	
		120	-	-	-	A77309039A1	13084	60111	-	3100Y20T8350	8910DPA22V02	-	HC-230120	
		208/240	-	-	-	A77309039A2	13085	60112	-	3100Y20U8350	8910DPA22V09	-	HC-230240	
2	30	24	DP2030A5004	DP2030A1003	R8243B1005	A77306657A3	14321	60030	91321	3100Y20Q6350CL	8910DP32V14	90-244	H2-23024	
		120	DP2030B5003	DP2030B1002	R4234B1004	A77306657A1	14322	60031	91322	3100Y20T6350CL	8910DP32V02	90-245	HC-230120	
		208/240	DP2030C5002	DP2030C1001	R4243B1012	A77306657A2	14323	60032	91323	3100Y20U6350CL	8910DP32V09	90-246	HC-230240	
2	30	24	DP2030A5012	-	-	A77309043A3	-	60130	-	3100Y20Q9350	8910DPA32V14	-	HC-23024	
		120	DP2030B5011	-	-	A77309042A1	-	60131	-	3100Y20T9350	8910DPA32V02	-	HC-230120	
		208/240	DP2030C5010	-	-	A77309042A2	-	60132	-	3100Y20U9350	8910DPA32V09	-	HC-230240	
2	40	24	DP2040A5003	DP2040A1002	R8243B1020	-	14421	60045	91421	3100Y20Q18350CL	8910DP42V14	90-247	HC-24024	
		120	DP2040B5002	DP2040B1001	-	-	-	14422	60046	91422	3100Y20T18350CL	8910DP42V02	90-248	HC-240120
		208/240	DP2040C5001	DP2040C1000	-	-	-	14423	60047	91423	3100Y20U18350CL	8910DP42V09	90-249	HC-240240
2	40	24	-	-	-	A77309045A3	-	60140	-	3100Y20Q10350	8910DPA42V14	-	HC-24024	
		120	-	-	-	A77309045A1	-	60141	-	3100Y20T10350	8910DPA42V02	-	HC-240120	
		208/240	-	-	-	A77309045A2	-	60142	-	3100Y20U10350	8910DPA42V09	-	HC-240240	
2	50	24	-	-	-	DP5C5023	-	-	-	3100Y20Q16350	8910DPA52V14	-	HC-35024	
		120	-	-	-	DP5C5021	-	-	-	3100Y20T16350	8910DPA52V02	-	HC-350120	
		208/240	-	-	-	DP5C5020	-	-	-	3100Y20U16350	8910DPA52V09	-	HC-350240	
2	60	24	-	-	-	DP5C6023	-	-	-	3100Y20Q17350	8910DPA62V14	-	HC-36024	
		120	-	-	-	DP5C6021	-	-	-	3100Y20T17350	8910DPA62V02	-	HC-360120	
		208/240	-	-	-	DP5C6022	-	-	-	3100Y20U17350	8910DPA62V09	-	HC-360240	
3	25	24	DP3025A5003	DP3025A1002	-	A77309042A3	14231	60115	91231	3100Y30Q8350	8910DPA23V14	90-160	HC-33024	
		120	DP3025B5002	DP3025B1001	-	A77309042A1	14232	60116	91232	3100Y30T8350	8910DPA23V03	90-161	HC-330120	
		208/240	DP3025C5001	DP3025C1000	-	A77309042A2	14233	60119	91233	3100Y30U8350	8910DPA23V09	90-162	HC-330240	
3	30	24	DP3030A5003	DP3020A1002	R8212G1209	A7730904A3	14331	60135	91331	3100Y30Q9350	8910DPA33V14	90-163	HC-33024	
		120	DP3030B5002	DP3020B1001	R4212R1014	A7730904A1	14332	60136	91332	3100Y30T9350	8910DPA33V03	90-164	HC-330120	
		208/240	DP3030C5001	DP3030C1000	-	A7730904A2	14333	60139	91333	3100Y30U9350	8910DPA33V09	90-165	HC-330240	
3	40	24	DP3040A5002	DP3040A1001	R8214G1140	A77309046A3	14431	60145	91431	3100Y30Q10350	8910DPA43V14	90-170	HC-34024	
		120	DP3040B5001	DP3040B1000	R4214G1347	A77309046A1	14432	60146	91432	3100Y30T10350	8910DPA43V03	90-171	HC-340120	
		208/240	DP3040C5000	DP3040C1009	-	A77309046A2	14433	60149	91433	3100Y30U10350	8910DPA43V09	90-172	HC-340240	
3	50	24	DP3050A5001	DP3050A1000	R8220B1051	DP5C5033	14531	60200	91531	3100Y30Q16350	8910DPA53V14	92-459	HC-35024	
		120	DP3050B5000	DP3050B1009	R4220B1009	DP5C5031	14532	60201	91532	3100Y30T16350	8910DPA53V03	92-460	HC-350120	
		208/240	DP3050C5009	DP3050C1008	R4220B1100	DP5C5032	14533	60202	91533	3100Y30U16350	8910DPA53V09	92-461	HC-350240	
3	60	24	DP3060A5000	DP3060A1009	R8234B1022	DP5C6033	14631	60205	91631	3100Y30Q17350	8910DPA63V14	92-463	HC-36024	
		120	DP3060B5009	DP3060B1008	R4234B1054	DP5C6031	14632	60206	91632	3100Y30T17350	8910DPA63V03	92-464	HC-360120	
		208/240	DP3060C5008	DP3060C1007	R4234B1062	DP5C6032	14633	60207	91633	3100Y30U17350	8910DPA63V09	92-465	HC-360240	
4	25	24	-	-	-	A77309026A3	-	-	-	3100Y40Q8350	8910DPA24V14	-	HC-43024	
		120	-	-	-	A77309026A1	-	-	-	3100Y40T8350	8910DPA24V03	-	HC-430120	
		208/240	-	-	-	A77309026A2	-	-	-	3100Y40U8350	8910DPA24V09	-	HC-430240	
4	30	24	-	-	-	A77309027A3	-	-	-	3100Y40Q9350	8910DPA34V14	-	HC-43024	
		120	-	-	-	A77309027A1	-	-	-	3100Y40T9350	8910DPA34V03	-	HC-430120	
		208/240	-	-	-	A77309027A2	-	-	-	3100Y40U9350	8910DPA34V09	-	HC-430240	
4	40	24	-	DP4040A1000	-	A77309028A3	-	-	-	3100Y40Q10350	8910DPA44V14	-	HC-44024	
		120	-	DP4040B1009	-	A77309028A1	-	-	-	3100Y40T10350	8910DPA44V03	-	HC-440120	
		208/240	-	DP4040C1008	-	A77309028A2	-	-	-	3100Y40U10350	8910DPA44V09	-	HC-440240	

Components

All reasonable effort has been made to accurately compose this contactor cross reference chart. However, product users are responsible to ensure actual product suitability & application use.

Shafts



67-61610
Illustrated

- Sized to bearing manufacturers specifications
- Slabbed on pulley end.
- Rust protected.
- Individually wrapped.
- Protective end caps.
- Part number and size listed on every shaft.

Part #	Diameter	Length	Reference
67-61100	3/4"	11"	Lennox, 2100157
67-61110		11 5/8"	Lennox
67-61212		12 3/4"	8-5-495C, 2100002
67-61400		14"	8-5-245C, 2100159
67-61550		15 5/16"	G9, G12-9, 2100160
67-61600		16"	8-6-23608, WW15X36, 2100162, 2100163, 2100198
67-61610		16 5/8"	8-5-240C, G10, G110, 2100011, 2100161
67-61800		18"	8-5-247C, 8-5-241C, 2100012
67-61920		19 1/8"	G12, 2100168
67-62000		20"	M90-256, RS620
67-62200		22"	2100013
67-62400		24"	8-5-243C
67-63600		36"	
67-82000		1"	20"
67-82400	24"		8-5-252C & 255C, M90-257, G15, 2100037, 55, 56, 2100166
67-83600	36"		P-S-209, M90-270, 2100168, 2100052, 210054

Bearings



67-4336-1
Illustrated



67-4036-2
Oil Type Illustrated



67-4136-2
Sealed Type Illustrated

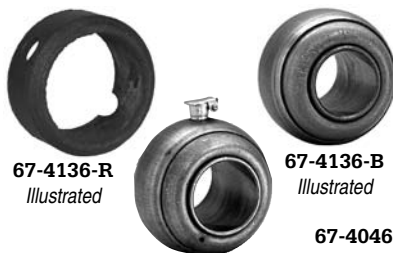

67-4136-R
Illustrated

67-4136-B
Illustrated

67-4046-B
Illustrated

Ball Bearings

Bearings complete with collar.

Part #	Bore	OD	Replaces
67-4336-1	3/4"	1 13/16"	LRCR
67-4336-2			(2) Bearings & (2) Collars
67-4346-1	1"	2 1/4"	RCR

Sleeve Bearing Paks

Kits include 2 bearings & 2 rubber sleeves.

Part #	Bore	OD	Type	Replaces
67-4036-2	3/4"	1 25/32"	Oil	Delhi
67-4046-2	1"	2 1/2"		Delhi
67-4135-2	5/8"	1 7/8"	Sealed	Lau
67-4136-2	3/4"	1 13/16"		Delhi
67-4137-2				Lau & Lennox
67-4138-2	1 7/8"	Torin		
67-4146-2	1"	2 1/2"		Delhi
67-4147-2				Lau & Lennox
67-4148-2			Torin	

Bearings & Sleeves

Part #	Bore	Type
67-4136-R	3/4"	Rubber sleeve
67-4146-R	1"	Rubber sleeve
67-4136-B	3/4"	Sealed bearing
67-4146-B	1"	Sealed bearing
67-4036-B	3/4"	Oil bearing
67-4046-B	1"	Oil bearing

67-2165
Illustrated



Thrust Collar Paks

Part #	Description
67-2164	(2) 5/8" collars & washers.
67-2165	(2) 3/4" collars & washers.
67-2166	(2) 1" collars & washers.

Ball Bearings

Bearing Types Available

- ZZ** - Double metallic shield (removable).
- 2RS** - Double Rubber (synthetic) shield.
- C3** - Radial internal clearance before mounting.



68-6000-2RS
Illustrated

Exploded View Of Ball Bearing

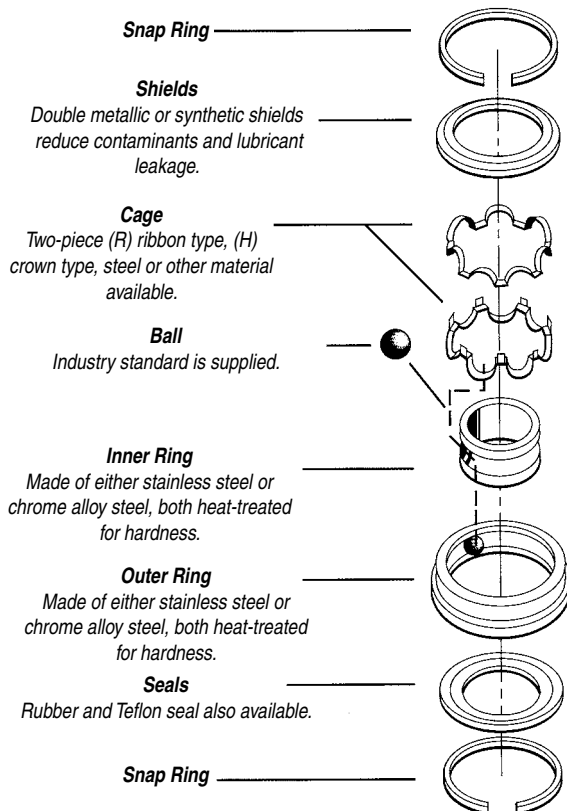

68-6000 Series

Add "2RS", "ZZ" or "C3" to end of part # when ordering.

Part #	ID		OD		Width	
	mm	inches	mm	inches	mm	inches
68-6000	10	0.3937	26	1.0236	8	0.3150
68-6001	12	0.4724	28	1.1024	8	0.3150
68-6002	15	0.5906	32	1.2598	9	0.3543
68-6003	17	0.6693	35	1.3780	10	0.3937
68-6004	20	0.7874	42	1.6535	12	0.4724
68-6005	25	0.9843	47	1.8504	12	0.4724
68-6006	30	1.1811	55	2.1654	13	0.5118
68-6007	35	1.3780	62	2.4409	14	0.5512
68-6008	40	1.5748	68	2.6772	15	0.5906
68-6009	45	1.7717	75	2.9528	16	0.6299
68-6010	50	1.9685	80	3.1496	16	0.6299
68-6011	55	2.1654	90	3.5433	18	0.7087
68-6012	60	2.3622	95	3.7402	18	0.7087
68-6013	65	2.5591	100	3.9370	18	0.7087
68-6014	70	2.7559	110	4.3307	20	0.7874
68-6015	75	2.9528	115	4.5276	20	0.7874
68-6016	80	3.1500	125	4.9212	22	0.8661
68-6017	85	3.3464	130	5.1181	22	0.8661
68-6018	90	3.5433	140	5.5118	24	0.9449

68-6200 Series

Add "2RS", "ZZ" or "C3" to end of part # when ordering.

Part #	ID		OD		Width	
	mm	inches	mm	inches	mm	inches
68-6200	10	0.3937	30	1.1811	9	0.3543
68-6201	12	0.4724	32	1.2598	10	0.3937
68-6202	15	0.5906	35	1.3780	11	0.4331
68-6203	17	0.6693	40	1.5748	12	0.4724
68-6204	20	0.7874	47	1.8504	14	0.5512
68-6205	25	0.9843	52	2.0472	15	0.5906
68-6206	30	1.1811	62	2.4409	16	0.6299
68-6207	35	1.3780	72	2.8346	17	0.6693
68-6208	40	1.5748	80	3.1496	18	0.7087
68-6209	45	1.7717	85	3.3465	19	0.7480
68-6210	50	1.9685	90	3.5433	20	0.7874
68-6211	55	2.1654	100	3.9370	21	0.8268
68-6212	60	2.3622	110	4.3307	22	0.8661
68-6213	65	2.5591	120	4.7244	23	0.9055
68-6214	70	2.7559	125	4.9213	24	0.9449
68-6215	75	2.9528	130	5.1181	25	0.9843
68-6216	80	3.1500	140	5.5118	26	1.0236
68-6217	85	3.3464	150	5.9055	28	1.1023

To convert inches to millimeters - multiply inches by 25.4

To convert millimeters to inches - divide millimeters by 25.4

Ball Bearings

Bearing Types Available

- ZZ - Double metallic shield (removable).
- 2RS - Double Rubber (synthetic) shield.
- C3 - Radial internal clearance before mounting.



68-6300 Series

Add "2RS", "ZZ" or "C3" to end of part # when ordering.

Part #	ID		OD		Width	
	mm	inches	mm	inches	mm	inches
68-6300	10	0.3937	35	1.3780	11	0.4331
68-6301	12	0.4724	37	1.4567	12	0.4724
68-6302	15	0.5906	42	1.6535	13	0.5118
68-6303	17	0.6693	47	1.8504	14	0.5512
68-6304	20	0.7874	52	2.0472	15	0.5906
68-6305	25	0.9843	62	2.4409	17	0.6693
68-6306	30	1.1811	72	2.8346	19	0.7480
68-6307	35	1.3780	80	3.1496	21	0.8268
68-6308	40	1.5748	90	3.5433	23	0.9055
68-6309	45	1.7717	100	3.9370	25	0.9843
68-6310	50	1.9685	110	4.3307	27	1.0630
68-6311	55	2.1654	120	4.7244	29	1.1417
68-6312	60	2.3622	130	5.1181	31	1.2205
68-6313	65	2.5591	140	5.5118	33	1.2992
68-6314	70	2.7559	150	5.9055	35	1.3780
68-6315	75	2.9528	160	6.2992	37	1.4567
68-6316	80	3.1500	170	6.6929	39	1.5354

Typical 2RS & ZZ Bearing

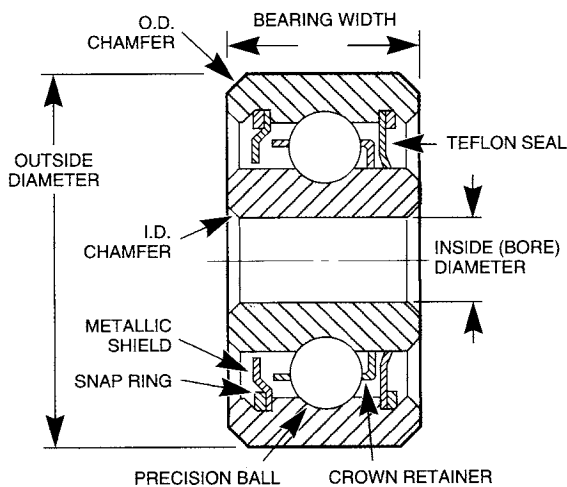

Add "2RS", "ZZ" or "C3" to end of part # when ordering.

Part #	ID		OD		Width	
	mm	inches	mm	inches	mm	inches
68-634	4	0.1575	16	0.6299	5	0.1969
68-625	5	0.1969	16	0.6299	5	0.1969
68-626	6	0.2362	19	0.7480	6	0.2362
68-607	7	0.2756	19	0.7480	6	0.2362
68-627	7	0.2756	22	0.8661	7	0.2756
68-608	8	0.3150	22	0.8661	7	0.2756
68-6201-500	13	0.5000	32	1.2598	10	0.3937
68-6201-13	13	0.5118	32	1.2598	10	0.3937
68-6202-500	13	0.5000	35	1.3780	11	0.4331
68-6202-625	16	0.6250	35	1.3780	11	0.4331
68-6202-16	16	0.6299	35	1.3780	11	0.4331
68-6203-625	16	0.6250	40	1.5748	12	0.4724
68-6203-16	16	0.6299	40	1.5748	12	0.4724
68-6203-2RSNR	17	0.6693	40	1.5748	12	0.4724
68-6203-750	19	0.7500	40	1.5748	12	0.4724
68-6204-875	22	0.8750	47	1.8504	14	0.5512
68-6205-1	25	1.0000	52	2.0472	15	0.5906

To convert inches to millimeters - multiply inches by 25.4

To convert millimeters to inches - divide millimeters by 25.4

Centrifugal Blower Wheels

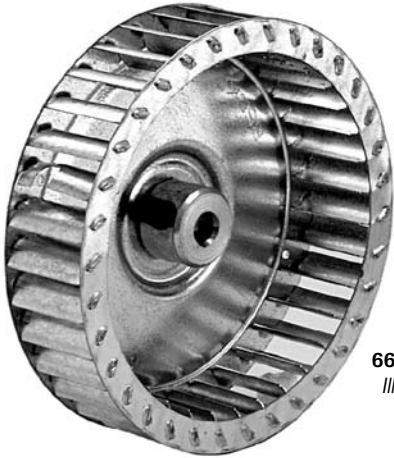

66-A8660
Illustrated

Applications

- Condensers
- Small Appliance
- Furnaces

Single Inlet Centrifugal Blower Wheels

- All single inlet blower wheels are galvanized steel.
- Rotation determined by viewing closed end.
- Wheel should be guarded.
- Tighten set screw securely.

Single Inlet Blower Wheels

Part #	Dia.	Width	Rot'n.	Bore	Max RPM
92-A8223	3 3/4"	2"	CW	1/4"	6500
92-A8222	3 3/4"	2"	CCW	1/4"	6500
66-A8650	3 13/16"	1 1/4"	CW	1/4"	7200
66-A8655	3 13/16"	1 1/4"	CCW	1/4"	7200
66-A8660	4"	1"	CW	1/4"	7200
66-A8664	4"	1 1/2"	CW	5/16"	
66-A8665	4"	2"	CW	5/16"	7200
66-A8666	4"	2"	CW	3/8"	4500
66-A8667	4"	2"	CCW	3/8"	4500
66-A8610	4 1/4"	2"	CCW	5/16"	3000
66-A8611	4 1/4"	2"	CW	5/16"	
66-A8640	4 1/4"	3"	CW	1/4"	3000
66-2-0542	4 3/4"	3"	CW	5/16"	3600
66-2-0328	4 3/4"	3"	CCW	5/16"	3600
66-2-0697	4 3/4"	3 1/2"	CW	5/16"	3600
66-2-0426	4 3/4"	3 1/2"	CCW	5/16"	3600
66-A508216	5"	2 1/2"	CCW	5/16"	3600
66-A8676	5 1/4"	1 1/4"	CCW	5/16"	2800
66-A508202	5 1/4"	2"	CCW	5/16"	3600
66-2-0253	5 1/4"	2 1/2"	CW	5/16"	3600
66-2-0047	5 1/4"	2 1/2"	CCW	5/16"	3600
66-2-0053	5 1/4"	3"	CW	5/16"	3600
66-2-0054	5 1/4"	3"	CCW	5/16"	3600
66-2-0281	5 3/4"	3"	CW	5/16"	3000
66-2-0350	5 3/4"	3"	CCW	5/16"	3000
66-2-1157	5 3/4"	3 1/2"	CW	5/16"	3000
66-2-0157	5 3/4"	3 1/2"	CCW	5/16"	3000
66-2-0353	5 3/4"	4"	CW	1/2"	2800
66-2-0338	5 3/4"	4"	CCW	1/2"	2800
66-A610215	6"	2 1/2"	CCW	5/16"	3600
66-A610220	6"	2 1/2"	CW	1/2"	3600
66-A610225	6"	2 1/2"	CCW	1/2"	3600
66-1-1548	6 5/32"	3 1/4"	CW	1/2"	2200

Table Continues

Single Inlet Blower Wheels -Table Continued

Part #	Dia.	Width	Rot'n.	Bore	Max RPM
66-1-4873	6 5/32"	3 1/4"	CCW	1/2"	2200
66-1-0098	6 5/32"	3 5/8"	CW	1/2"	2000
66-1-4952	6 5/32"	3 5/8"	CCW	1/2"	2000
66-1-9339	6 5/16"	3 7/8"	CW	1/2"	2000
66-1-9340	6 5/16"	3 7/8"	CCW	1/2"	2000
66-1-1077	6 5/16"	4"	CW	1/2"	2000
66-1-9341	6 5/16"	4"	CCW	1/2"	2000
66-A8652	6 5/8"	1 7/16"	CW	5/16"	4000
66-1-1074	7 1/8"	3 1/2"	CW	1/2"	1700
66-1-8350	7 1/8"	3 1/2"	CCW	1/2"	1700
66-1-5931	7 1/8"	3 3/4"	CW	1/2"	1500
66-1-9343	7 1/8"	3 3/4"	CCW	1/2"	1500
66-1-0166	7 1/8"	4"	CW	1/2"	1500
66-1-3978	7 1/8"	4"	CCW	1/2"	1500
66-1-4879	7 1/2"	3 1/2"	CW	1/2"	1800
66-1-6887-R	7 1/2"	9"	CCW	1/2"	1600
66-1-6071	8"	3 1/2"	CCW	1/2"	1850
66-1-0464	8"	3 1/2"	CW	1/2"	1850
66-1-0203	8"	3 1/2"	CCW	1/2"	1850
66-1-0206	8"	4"	CW	1/2"	1650
66-1-0207	8"	4"	CCW	1/2"	1650
66-1-3705	8 1/2"	3"	CW	1/2"	2050
66-1-9344	8 1/2"	3"	CCW	1/2"	2050
66-1-5266	9 1/8"	4 1/4"	CW	1/2"	1500
66-1-5693	9 1/8"	4 1/4"	CCW	1/2"	1500
66-1-4697	9 1/8"	5"	CW	1/2"	1350
66-1-0242	9 1/8"	5"	CCW	1/2"	1350
66-1-4620	9 7/8"	4"	CW	1/2"	1350
66-1-9342	9 7/8"	4"	CCW	1/2"	1350
66-1-2073	9 7/8"	6"	CW	1/2"	1100
66-1-2074	9 7/8"	6"	CCW	1/2"	1100

Centrifugal Blower Wheels

Double Inlet Centrifugal Blower Wheels

- Double inlet blower wheels are either galvanized steel or aluminum.
- Rotation determined by viewing hub extension.
- Wheel should be guarded.
- Tighten set screw securely.



66-A8675
Illustrated

Applications

- Condensers
- Small Appliance
- Furnaces

Double Inlet Blower Wheels

Part #	Dia.	Width	Rot'n.	Bore	Made	Max Rpm
66-A8675	3 3/4"	3 3/12	CCW	5/16	Galv.	5000
66-2-6480	4"	5"	CW			
66-2-0414	4 3/4"	7"	CW	1/2"	Alum.	3600
66-2-0415	4 3/4"	7"	CCW	1/2"	Alum.	3600
66-2-0223	5 1/4"	7"	CW	1/2"	Galv.	3600
66-2-0891	5 1/4"	7"	CCW	1/2"	Galv.	3600
66-1-8045	5 1/2"	5"	?	21/32"	?	?
66-1-2657	5 1/2"	6 1/2"	CW	1/2"	Galv.	2800
66-1-2873	5 1/2"	6 1/2"	CCW	1/2"	Galv.	2800
66-2-0600	5 3/4"	7 5/8"	CW	1/2"	Galv.	3000
66-2-0678	5 3/4"	7 5/8"	CCW	1/2"	Galv.	3000
66-1-4721	5 3/4"	7 7/8"	CW	1/2"	Alum.	1800
66-1-0439	6 1/4"	7"	CW	1/2"	Galv.	2050
66-1-0438	6 1/4"	7"	CCW	1/2"	Galv.	2050
66-2-0549	6 1/4"	7 5/8"	CW	1/2"	Galv.	1800
66-2-0749	6 1/4"	7 5/8"	CCW	1/2"	Galv.	1800
66-1-0315	6 1/4"	7 7/8"	CW	1/2"	Alum.	1725
66-1-6005	7/18"	4"	CCW	1/2"	?	1500
66-1-0336	7 1/2"	4"	CW	3/4"	Galv.	2700
66-1-0337	7 1/2"	4"	CCW	3/4"	Galv.	270
66-1-8677	7 1/2"	4 1/2"	CW	3/4"	Galv.	2500
66-1-8678	7 1/2"	4 1/2"	CCW	3/4"	Galv.	2500
66-1-0343	7 1/2"	6"	CW	3/4"	Galv.	1950
66-1-0344	7 1/2"	6"	CCW	3/4"	Galv.	1950
66-1-3226	7 1/2"	9"	CW	1/2"	Alum.	1550
66-1-9338	9 1/2"	4"	CW	1/2"	Galv.	2100
66-1-2204	9 1/2"	6"	CW	1/2"	Galv.	1750
66-1-3028	9 1/2"	7"	CW	1/2"	Galv.	1550
66-1-3184	9 1/2"	8"	CW	1/2"	Galv.	1400
66-1-2286	9 1/2"	9 1/4"	CW	1/2"	Galv.	1300
66-1-1532	10 3/4"	4 1/4"	CW	1/2"	Galv.	1750
66-1-1094	10 3/4"	6"	CW	1/2"	Galv.	1550
66-1-3101	10 3/4"	7"	CW	1/2"	Galv.	1350
66-1-2483	10 3/4"	7 3/4"	CW	1/2"	Galv.	1250
66-1-1266	10 3/4"	9 1/4"	CW	1/2"	Galv.	1200
66-1-2640	10 3/4"	10 1/2"	CW	1/2"	Galv.	1150

Aluminum Pulleys



67-4325
Illustrated

Variable Speed Pulleys

Part #	Bore	Dia
67-4325	1/2"	3 1/4"
67-4350		3 1/2"
67-4375		3 3/4"
67-4400		4"
67-5325	5/8"	3 1/4"
67-5350		3 1/2"
67-5375		3 3/4"
67-5400		4"



67-660
Illustrated

Blower Pulleys

Part #	Bore	Dia
67-650	3/4"	5"
67-660		6"
67-670		7"
67-680		8"
67-690	1"	9"
67-610		10"
67-612		12"

Table Continued

Part #	Bore	Dia
67-860	1"	6"
67-870		7"
67-880		8"
67-890		9"
67-810	1 1/2"	10"
67-812		12"

Plastic Fan Blades

Features

- Lightweight and Durable
- Reduce Air Noise
- Improved Motor Bearing Life
- Eliminate Bent Blades

Fixed - Hub Type

Part #	Bore	Rotation	Diameter	# of Blades
93-40421	1/8"	CW	4.00"	4
93-40522	1/8"	CCW	4.00"	5
93-45522	1/8"	CCW	4.50"	5
93-35431	3/16"	CW	3.50"	4
93-40531	3/16"	CW	4.00"	5
93-60431	3/16"	CW	6.00"	4
93-50432	3/16"	CCW	5.00"	4
93-55432	3/16"	CCW	5.50"	4
93-60432	3/16"	CCW	6.00"	4
93-40541	1/4"	CW	4.00"	5
93-65571	7/32"	CW	6.50"	5



Impeller Type

Part #	Diameter	Width	Shaft Size
93-A7100	4.50"	1.0625"	7/32" (W/ FLAT)
93-A7105	5.00"	1.25"	7/32 (EB50)

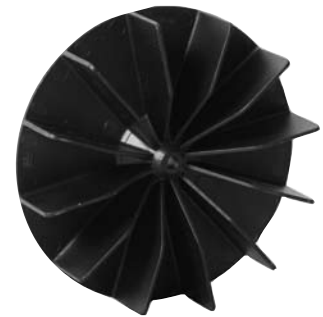

Unit Bearing - Hubless Type

Part #	Rotation	Diameter	# of Blades
93-A7353	CCW	4.00"	4
93-A7351	CW	4.00"	5
93-A7352	CCW	4.00"	5



Flue Exhaust Motor Cooling Blades



1 3/4" Diameter
5/16" Hub I.D. with 1/4"

Keeprite - Blade Only
504015K

92-FMK CW ROTATION
92-FMK1 CCW ROTATION

93-31042 3" x 1/4"
93-41042 4" x 1/4"

Metal Fan Blades

Unit Bearing - Hubless Type



Typical Applications

- Freezers
- Refrigerators

Features

- 7" - 10" Diameter
- High Quality Aluminium Blades

5 Blades

Part #	Rot	Dia	Pitch	
93-A7022	CW	7"	15°	
93-A7023	CW		20°	
93-A7024	CCW		20°	
93-A7025	CW		25°	
93-A7026	CW		30°	
93-A7027	CCW		30°	
93-A7005	CW		38°	
93-A7028	CW		40°	
93-A7030	CW		7 3/4"	21°
93-A7033	CW		8"	25°
93-A7034	CW	30°		
93-A7035	CCW	30°		
93-A7029	CCW	30°		
93-A7042	CW	40°		
93-A7036	CCW	40°		
93-A7039	CW	8 3/4"	30°	
93-A7040	CCW		30°	
93-A7041	CW	10"	23°	

3 Blades

Part #	Rot	Dia	Pitch
93-A7332	CW	7"	32°
93-A7008	CW	7 3/4"	18°
93-A7009	CW		32°
93-A8332	CW	8 1/2"	32°
93-A7014	CCW	8 3/4"	30°
93-A7018	CW	9 1/2"	20°

Performance Tables

Order By : Part number or Diameter,
Pitch and Number of blades

One Piece - Fixed Hub Type

Features

- 5 Blade
- 5 1/2" - 10" diameter
- High quality aluminium blades
- CW fans have hub attached on discharge side
- CCW fans have hub attached on intake side
- Zinc and chromate coated hub
- For motor speeds up to 3450 RPM

Typical Applications

- Freezers
- Refrigerators
- Heaters

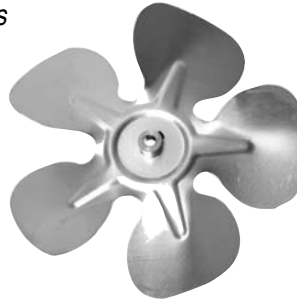

Performance Tables

Order By : Part number or Diameter,
Pitch and Number of blades

Part #	Rot	Dia	Pitch	Bore	Replace
93-6-4587	CW	5 1/2"	27°	1/4"	GE7451
93-6-4588	CCW	5 1/2"	27°	1/4"	GE7452
93-6-4589	CW	5 1/2"	27°	5/16"	GE7551
93-6-4590	CCW	5 1/2"	27°	5/16"	GE7552
93-6-4591	CW	7"	27°	1/4"	GE7471
93-6-4592	CCW	7"	27°	1/4"	GE7472
93-6-4593	CW	7"	27°	5/16"	GE7571
93-6-4594	CCW	7"	27°	5/16"	GE7572
93-6-4595	CW	8"	24°	1/4"	GE7481
93-6-4596	CCW	8"	24°	1/4"	GE7482
93-6-4597	CW	8"	24°	5/16"	GE7581
93-6-4598	CCW	8"	24°	5/16"	GE7582
93-6-4599	CW	8"	32°	1/4"	GE7483

Part #	Rot	Dia	Pitch	Bore	Replace
93-6-4600	CCW	8"	32°	1/4"	GE7484
93-6-4601	CW	8"	32°	5/16"	GE7583
93-6-4602	CCW	8"	32°	5/16"	GE7585
93-6-4603	CW	9"	26°	1/4"	GE7491
93-6-4604	CCW	9"	26°	1/4"	GE7492
93-6-4605	CW	9"	26°	5/16"	GE7591
93-6-4606	CCW	9"	26°	5/16"	GE7592
93-6-4607	CW	10"	20°	1/4"	GE7493
93-6-4608	CCW	10"	20°	1/4"	GE7494
93-6-4609	CW	10"	20°	5/16"	GE7593
93-6-4610	CCW	10"	20°	5/16"	GE7594
93-6-4611	CW	10"	31°	5/16"	GE7595
93-6-4612	CCW	10"	31°	5/16"	GE7596

Free-Air Type Fan Blades - Interchangeable Hub

Typical Applications

- Pedestal Fans
- Wall and Roof Exhausters
- Air Circulators
- Window Fans
- Commercial Ventilation Equipment
- Unit Heaters

3 Blades

Part #	Rot	Dia	Pitch	
93-6-4300	CW	10"	23°	
93-6-4301	CCW		23°	
93-6-4302	CW		27°	
93-6-4303	CCW		27°	
93-6-4304	CW	12"	23°	
93-6-4306	CW		27°	
93-6-4308	CW	14"	23°	
93-6-4309	CCW		23°	
93-6-4312	CW	16"	23°	
93-6-4313	CCW		23°	
93-6-4314	CW		27°	
93-6-4315	CCW		27°	
93-6-4316	CW		18"	23°
93-6-4318	CW		20"	23°
93-6-4320	CW	24"	12°	
93-6-4321	CCW		12°	
93-6-4322	CW		18°	

4 Blades

Part #	Rot	Dia	Pitch
93-6-4324	CW	10"	23°
93-6-4325	CCW		23°
93-6-4326	CW		27°
93-6-4328	CW		33°
93-6-4329	CCW	12"	33°
93-6-4330	CW		23°
93-6-4331	CCW	14"	23°
93-6-4332	CW		27°
93-6-4333	CCW		27°
93-6-4334	CW		33°
93-6-4335	CCW		33°
93-6-4336	CW		23°
93-6-4337	CCW	14"	23°
93-6-4338	CW		27°
93-6-4339	CCW		27°
93-6-4340	CW		33°
93-6-4341	CCW	33°	

4 Blades (cont.)

Part #	Rot	Dia	Pitch
93-6-4342	CW	16"	23°
93-6-4343	CCW		23°
93-6-4344	CW		27°
93-6-4345	CCW		27°
93-6-4347	CCW	18"	33°
93-6-4348	CW		23°
93-6-4350	CW	20"	27°
93-6-4351	CCW		27°
93-6-4353 ¹	CCW		33°
93-6-4354	CW		23°
93-6-4355	CCW		23°
93-6-4356	CW		27°
93-6-4357	CCW	24"	27°
93-6-4358 ²	CW		33°
93-6-4359 ²	CCW		33°
93-6-4362 ²	CW		18°
93-6-4363 ²	CCW	24"	18°
93-6-4354 ²	CW		23°
93-6-4365 ²	CCW		23°
93-6-4367 ²	CCW	27°	



Features

- 3 or 4 Blade
- 10" - 24" diameter
- High quality heavy duty aluminium blades
- Maximum air delivery, minimum noise
- Zinc and dichromate plated steel spiders
- For motor speeds up to 1725 RPM

Performance Tables

Order By : Part number or Diameter, Pitch and Number of blades
 1 = Rated to 1550 RPM
 2 = Rated to 1140 RPM

Pressure (condenser) Type Fan Blades - Interchangeable Hub

Typical Applications

- Air Conditioning Condensers
- Power Roof Ventilators
- Heat Pumps
- Heat Exchangers
- Commercial & Industrial Equipment
- Unit Heaters

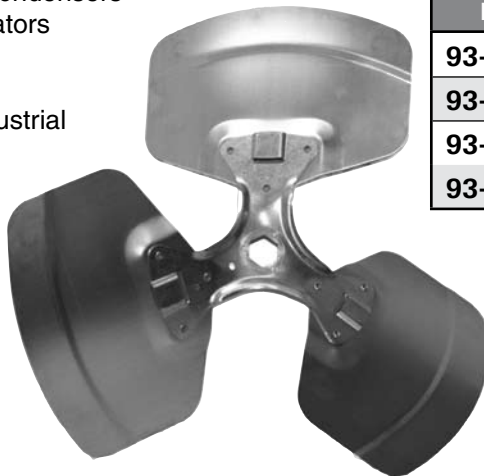

2 Blades

Part #	Rot	Dia	Pitch
93-6-4941	CCW	18"	27°
93-6-4942	CCW	20"	25°
93-6-4943	CCW	22"	18°
93-6-4944	CCW		27°

3 Blades

Part #	Rot	Dia	Pitch
93-6-4368	CW	18"	27°
93-6-4369	CCW		27°
93-6-4371	CCW		30°
93-6-4372	CW		33°
93-6-4374	CW	20"	24°
93-6-4377	CCW		28°
93-6-4379	CCW		31°
93-6-4382	CW	22"	35°
93-6-4383	CCW		35°
93-6-4384	CW	24"	26°
93-6-4386	CW		33°
93-6-4387	CCW		33°

Features

- 18" - 24" diameter
- High quality heavy duty aluminium blades
- Maximum air delivery, minimum noise
- Zinc and dichromate plated steel spiders
- For motor speeds up to 1140 RPM

Performance Tables

Order By : Part number or Diameter, Pitch and Number of blades

Pressure (condenser) Type Fan Blades - Interchangeable Hub

Typical Applications

- Air Conditioning Condensers
- Power Roof Ventilators
- Heat Pumps
- Heat Exchangers
- Commercial & Industrial Equipment
- Unit Heaters

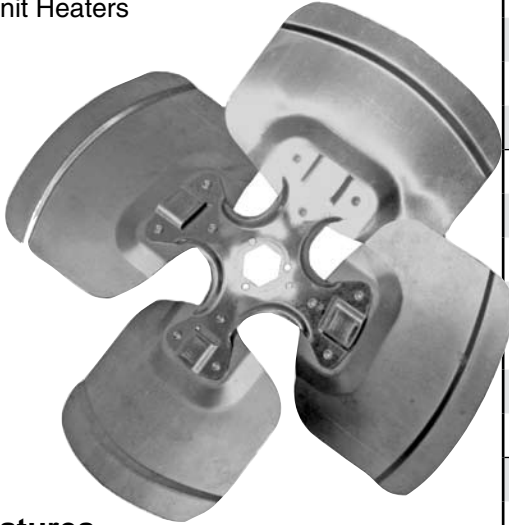

Features

- 10" - 26" diameter
- High quality heavy duty aluminium blades
- Maximum air delivery, minimum noise
- Zinc and dichromate plated steel spiders
- For motor speeds up to 1625 RPM

4 Blades

Part #	Rot	Dia	Pitch
93-6-4328	CW	10" ^{m2}	33°
93-6-4329	CCW		33°
93-6-4330	CW	12" ^{m2}	23°
93-6-4331	CCW		23°
93-6-4334	CW		33°
93-6-4335	CCW	14"	33°
93-6-4388	CW		23°
93-6-4389	CCW		23°
93-6-4390	CW		33°
93-6-4391	CCW	16"	33°
93-6-4392	CW		23°
93-6-4393	CCW		23°
93-6-4394	CW	18"	33°
93-6-4396	CW		27°
93-6-4397	CCW		27°

4 Blades (cont.)

Part #	Rot	Dia	Pitch
93-6-4402	CW	20"	26°
93-6-4403	CCW		26°
93-6-4404	CW	22"	29°
93-6-4406	CW		33°
93-6-4407	CCW		33°
93-6-5736	CW	24"	23°
93-6-5741	CCW		23°
93-6-4408	CW		27°
93-6-4409	CCW		27°
93-6-4411	CCW	26"	35°
93-6-5737	CW		18°
93-6-5738	CW		23°
93-6-5743	CCW		23°
93-6-4412	CW		27°
93-6-4413	CCW	27°	27°
93-6-4414	CW		33°
93-6-4415	CCW	27°	33°
93-6-4416	CW		27°
93-6-4419	CCW		27°

Performance Tables

Order By : Part number or Diameter, Pitch and Number of blades

Interchangeable Hex Hubs

Part #	Dia.	# Of Set Screws
93-217-002	5/16"	1
93-217-003	3/8"	1
93-217-004	1/2"	2
93-217-004	5/8"	2

Fits All Interchangeable Hub Type Fan Blades

- Pre-tapped holes with mounting & set screws started
- Packaged 12/carton; Order in multiples of 12/size
- Bore sizes to fit most field applications
- Zinc & dichromate plated alloy steel
- Simple screw design



Pressure (condenser) Type Fan Blades - Fixed Hub

Typical Applications

- Air Conditioning Condensers
- Power Roof Ventilators
- Heat Pumps
- Heat Exchangers
- Commercial & Industrial Equipment
- Unit Heaters



Features

- 14" - 24" diameter
- High quality heavy duty aluminium blades
- 1/2" bore, shaved & staked hub, attached on intake side
- Zinc and dichromate plated steel spiders
- For motor speeds up to 1625 RPM

3 Blades

Part #	Rot	Dia	Pitch
93-6-4227	CW	14"	33°
93-6-4228	CCW		33°
93-6-4229	CW	16"	33°
93-6-0896	CW	18"	33°
93-6-4231	CCW		33°
93-6-0899	CW	20"	33°
93-6-4232	CCW		33°
93-6-4233	CW	22"	33°
93-6-4235	CW	24"	33°

4 Blades

Part #	Rot	Dia	Pitch
93-6-4238	CW	16"	33°
93-6-4240	CW	18"	33°
93-6-4241	CCW		33°
93-6-4242	CW	20"	33°
93-6-4245	CCW	22"	33°
93-6-4246	CW	24"	33°
93-6-4247	CCW		33°

Performance Tables

Order By : Part number or Diameter, Pitch and Number of blades

Heavy Duty, All Steel Type Fan Blades

Typical Applications

- Commercial Air Conditioning & Ventillation
- Air Handlers
- Cooling Towers
- Agricultural Applications
- Large Unit Heaters

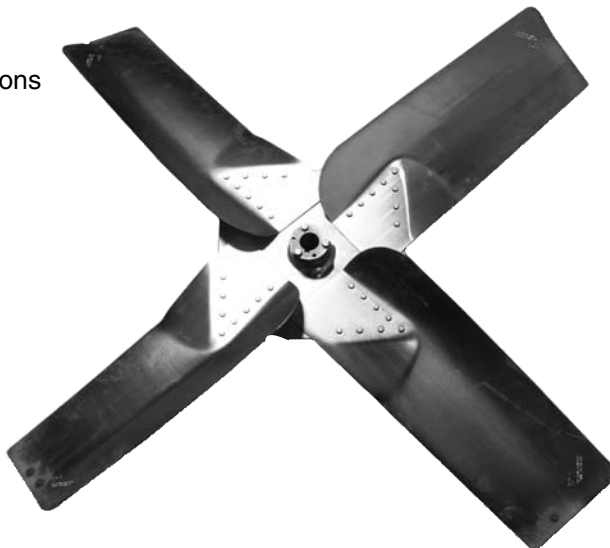

Part #	Rot	Dia	Pitch
93-5-2186*	CW	26" ²	
93-5-2225		26"	
93-5-2241		28"	38°
93-5-2190		36"	
93-5-2191		42"	

Performance Tables

Order By : Part number or Diameter, Pitch and Number of blades

* = Furnished with 3/4" fixed bore hub on discharge side. Comes with 2 set screws and standard keyway. Key not included.

Split Tapered Bushings

Features

- For 1/2" - 1-3/8" bore ranges
- Malleable iron construction
- Two-bolt design
- Two 1/4-20 x 3/4" cap screws provided
- Packaged individually



Part #	Pitch	Part #	Pitch
67-QH1/2	1/2"	67-QH1	1"
67-QH5/8	5/8"	67-QH1-1/8	1 1/8"
67-QH3/4	3/4"	67-QH1-3/16	1 3/16"
67-QH7/8	7/8"	67-QH1-3/8	1 3/8"

Blower Wheel Pullers



*Blower Wheel Puller Kit

92-CD3570

Includes all sizes plus a carrying case

Part #	Discription
92-CD3500	Drive Bolts, Shank & 1 1/4" Hub
92-CD3510	Drive Bolts, Shank & 1 3/8" Hub
92-CD3520	Drive Bolts, Shank & 1 1/2" Hub
92-CD3530	Drive Bolts, Shank & 1 5/8" Hub
92-CD3505*	1 1/4" Hub Only
92-CD3515*	1 3/8" Hub Only
92-CD3525*	1 1/2" Hub Only
92-CD3535*	1 5/8" Hub Only
92-CD3540*	Pin & Drive Bolt
92-CD3555	Set Screw (3/Pkg.)
92-CD3560*	5/32" Allen Wrench
92-CD3565*	1" Sears Adapter

Motor Mounting Bases

48 Frame Resilient Mount Kit

92-A240	9" Blowers (2 1/2" Rings)
92-A241	12" Blowers (2 1/2" Rings)
92-A242	10" Blowers (2 1/2" Rings)



Fits 1 3/4" Resilient Rings

Part #	Shaft Height	"A"
92-A8041	2 1/4"	4.4"
92-A8042	2 1/4"	4.6"

Fits 2 1/2" Resilient Rings

Part #	Shaft Height	"A"
92-A8035	2 1/2"	4.7"
92-A8043	2 1/2"	5.0"

Convert Hub to Resilient Ring

For 3 1/2" ht. c/w mounting base, 2 resilient rings, 2 latch assemblies, 2 end caps and a slinger

Part #	"A"	Fits
92-A8279	8.6"	S1450, S1454, T2532
92-A8280	8.1"	S1452, T2532, T2534
92-A8281	11.1"	T2536, T2537, T2539, T2544
92-A8282	10.1"	T2542, T2543
92-A8283	9.1"	T2538, T2540

Fits 2 1/4" Resilient Rings

Part #	Shaft Height	"A"
92-A8044	2 5/8"	5.3"
92-A8045		5.5"
92-A8076		6.0"
92-A8077		6.5"
92-A8069	3"	5.0"
92-A8078		5.1"
92-A8070		5.3"
92-A8052	3 1/2"	4.0"
92-A8053		4.3"
92-A8054		4.5"
92-A8057		5.3"
92-A8058		5.6"
92-A8059		6.5"

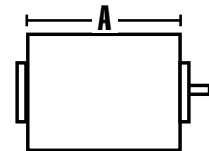

Motor Mounting Accessories

Base Mounting Adapter Kit

For 5 1/2" with flat end shields or use on extended thru-bolt motors to gain additional length to fit old base



Part #	Description
92-A8095	Includes (1) adapter plate w/ mounting ring, (4) split rings, (8) nuts & (4) lock washers



Base Clips

Part #	Description
92-A8092	Set of 2 alluminium clips for 4.1" motors bases
92-A8094	Set of 2 spring clips for 5.0" motor bases
92-A8096	Set of 2 clips for 5.5" motor bases
92-A8098	Set of 2 clips for 6.5" motor bases
92-A8233	Set of 4 studs and nuts for 11 frame motor
92-A8236	Set of 4 studs and nuts for 21/29 frame motor

Resilient Clips

Part #	Description
92-A8104	2 1/4" Unbonded cushion ring
92-A8105	2 1/4" Bonded cushion ring
92-A8106	2 1/4" Hubbed to resilient (2 resil. rings, 4 split rings)
92-A8031	2 1/4" Rings to 2 1/2" rings converter (4 split rings)
92-A8103	2 1/2" Unbonded cushion ring
92-A8102	2 1/2" Bonded cushion ring
92-A8107	2 1/2" Hubbed to resilient(2 Resil. rings, 4 split rings)

Mounting Bases



Transition Bases (Adapters)

A transition base inserted under the motor feet (one on each side) will allow you to compensate for the difference in the mounting dimensions and shaft height of a rigid base "T" Frame to the next higher "U" Frame. It has the same heavy duty fabrication as the slide rails. For horizontal mounting only. Shimming may be necessary for direct coupled loads. Thread size shown is for mounting base to the "T" Frame motor. Dimensions listed are for one piece - two are supplied

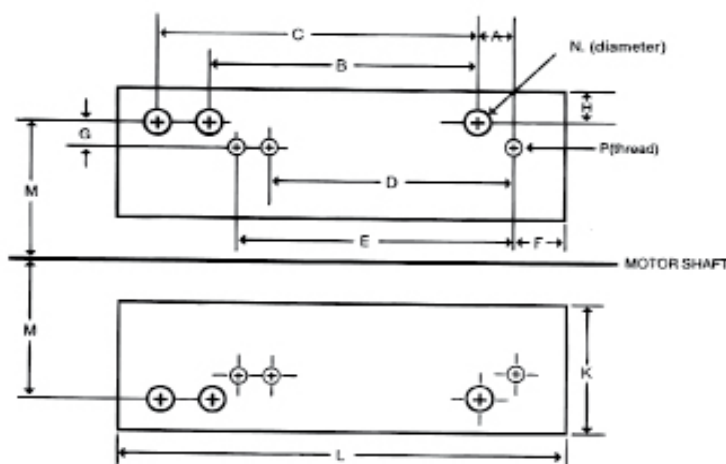

Part #	"T" Frame Converts	To "U" Frame	(OAHT) Height	A	B	C	D	E	F	G	H	K	L	M	N	P
92-1814T	143T/145T	182/184	1	1/2	4 1/2	5 1/2	4	5	3/4	1	1/2	2 1/4	7 1/2	3 3/4	7/16	5/16 - 18
92-2118T	182T/184T	213/215	3/4	1	5 1/2	7	4 1/2	5 1/2	1	1/2	5/8	1 7/8	9 1/2	4 1/4	7/16	3/8 - 16
92-25U21T	213T/215T	254U/256U	1	1 1/8	8 1/4	10	5 1/2	7	1	3/4	3/4	2 1/2	13	5	9/16	3/8 - 16
92-28U25T	254T/256T	284U/286U	3/4	1 3/8	9 1/2	11	8 1/4	10	1 1/4	1/2	3/4	2 1/2	14 1/2	5 1/2	9/16	1/2 - 13
92-32U28T	284T/286T	324U/326U	1	1 1/2	10 1/2	12	9 1/2	11	1 1/2	3/4	3/4	3	16	6 1/4	11/16	1/2 - 13
92-36U32T	324T/326T	364U/365U	1	1 3/4	11 1/4	12 1/4	10 1/2	12	1 3/4	3/4	3/4	3 1/2	16 3/4	7	11/16	5/8 - 11
92-40U36T	364T/365T	404U/405U	1	2	12 1/4	13 3/4	11 1/4	12 1/4	2	1	1 1/4	4	18 3/4	8	13/16	5/8 - 11
92-44U40T	404T/405T	444U/445U	1	2 1/4	14 1/2	16 1/2	12 1/4	13 3/4	2 1/4	1	1 1/4	4	22	9	13/16	3/4 - 10

Components

Motor Mounting Accessories

Adjusting Motor Bases (Slide Rails)

- From NEMA 56 to 588 T FRAME
- Heavy duty steel fabrication
- Rust and corrosion resistant
- Continuous welds on all units
- Zinc plated adjusting screw
- Gussets and reinforced channels on larger units
- Four mounting bolts included with each base (D BOLT)

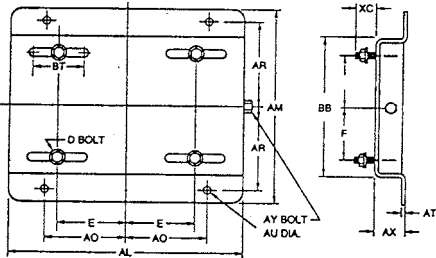

Fig.1

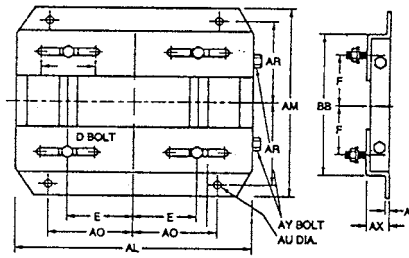

Fig.2

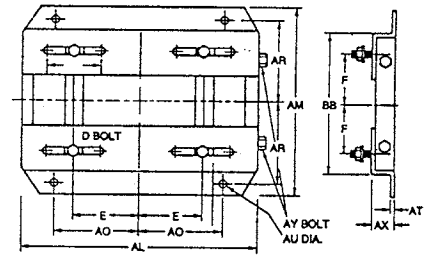

Fig.3

Part No.	Fr. Size	Fig.	AL	AM	AX	BB	E	F	AO	AR	AU	XB	AT	D (BOLT)	AY (BOLT)
92-056	56	1	10 5/8	6 1/2	1 1/8	4 1/2	2 7/8	3	7 5/8	5 3/4	3/8	3 1/2	0.076	5/16 x 1	3/8 x 4
92-143	143T		10 1/2	7 1/2	1 1/8	5 1/2	3 1/2	4	7 1/2	6 3/4	3/8	3 1/4	0.119	5/16 x 1	3/8 x 5
92-145	145T		10 1/2	8 1/2	1 1/8	6 1/2	5 1/2	5	7 1/2	7 3/4	3/8	3 1/4	0.119	5/16 x 1	3/8 x 5
92-182	182T		12 3/4	9 1/2	1 1/2	6 1/2	7 1/2	4 1/2	9	8 1/2	1/2	4	0.134	3/8 x 1 1/2	1/2 x 6
92-184	184T		12 3/4	10 1/2	1 1/2	7 1/2	7 1/2	5 1/2	9	9 1/2	1/2	4	0.134	3/8 x 1 1/2	1/2 x 6
92-213	213T		15	11	1 3/4	7 1/2	8 1/2	5 1/2	10 1/2	9 1/2	1/2	4	0.164	3/8 x 1 1/2	1/2 x 6
92-215	215T		15	12 1/2	1 3/4	9	8 1/2	7	10 1/2	11	1/2	4	0.164	3/8 x 1 1/2	1/2 x 6
92-254	254T	2	17 3/4	15 1/8	2	10 3/4	10	8 1/4	12 1/2	13 1/4	5/8	4 1/2	3/16	1/2 x 1 3/4	5/8 x 9
92-256	256T		17 3/4	16 7/8	2	12 1/2	10	10	12 1/2	15	5/8	4 1/2	3/16	1/2 x 1 3/4	5/8 x 9
92-284	284T		19 3/4	16 7/8	2	12 1/2	11	9 1/2	14	15	5/8	4 1/2	3/16	1/2 x 1 3/4	5/8 x 9
92-286	286T		19 3/4	18 3/8	2	14	11	11	14	16 1/2	5/8	4 1/2	3/16	1/2 x 1 3/4	5/8 x 9
92-324	324T		22 3/4	19 1/4	2 1/2	15 1/2	12 1/2	10 1/2	16	17	3/4	5 1/4	3/16	5/8 x 2 1/2	3/4 x 11
92-326	326T		22 3/4	20 3/4	2 1/2	15 1/2	12 1/2	12	16	18 1/2	3/4	5 1/4	3/16	5/8 x 2 1/2	3/4 x 11
92-364	364T		25 1/2	20 1/2	2 1/2	15 1/2	14	11 1/4	18	18 1/4	3/4	6 1/2	1/4	5/8 x 2 1/2	3/4 x 11
92-365	365T	25 1/2	21 1/2	2 1/2	16 1/2	14	12 1/4	18	19 1/4	3/4	6 1/2	1/4	5/8 x 2 1/2	3/4 x 11	
92-404	404T	3	28 3/4	22 3/8	3	16 1/2	16	12 1/4	20	19 3/4	7/8	7 1/2	1/4	3/4 x 2 3/4	3/4 x 11
92-405	405T		28 3/4	23 7/8	3	18	16	13 3/4	20	21 1/4	7/8	7 1/2	1/4	3/4 x 2 3/4	3/4 x 13
92-444	444T		31 1/4	24 5/8	3	19 1/4	18	14 1/2	22	22	7/8	7 3/4	5/16	3/4 x 2 3/4	3/4 x 13
92-445	445T		31 1/4	26 5/8	3	21 1/4	18	16 1/2	22	24	7/8	7 3/4	5/16	3/4 x 2 3/4	3/4 x 13
92-447	447T		31 1/4	30 1/8	3	24 3/4	18	20	22	27 1/2	7/8	7 3/4	5/16	3/4 x 3	3/4 x 14
92-449	449T		31 1/4	35 1/8	3	29 3/4	18	25	22	32 1/2	7/8	7 3/4	5/16	3/4 x 3	3/4 x 14
92-504	504T		35	28	3 1/2	20 3/4	20	16	25	25	1	8 3/4	5/16	7/8 x 3 1/2	7/8 x 16
92-505	505T		35	30	3 1/2	22 3/4	20	18	25	27	1	8 3/4	5/16	7/8 x 3 1/2	7/8 x 16
92-506	506T		35	32	3 1/2	24 3/4	20	20	25	29	1	8 3/4	5/16	7/8 x 3 1/2	7/8 x 16
92-507	507T		35	34	3 1/2	26 3/4	20	22	25	31	1	8 3/4	5/16	7/8 x 3 1/2	7/8 x 16
92-508	508T	35	37	3 1/2	29 3/4	20	25	25	34	1	8 3/4	5/16	7/8 x 3 1/2	7/8 x 16	
92-509	509T	35	40	4	32 3/4	20	28	25	37	1	8 3/4	5/16	7/8 x 3 1/2	7/8 x 16	
92-583	583T	38 3/4	29	4	20 3/4	23	16	29	26	1	9 3/4	3/8	7/8 x 3 1/2	7/8 x 16	
92-584	584T	38 3/4	31	4	22 3/4	23	18	29	28	1	9 3/4	3/8	7/8 x 3 1/2	7/8 x 16	
92-585	585T	38 3/4	33	4	24 3/4	23	20	29	30	1	9 3/4	3/8	7/8 x 3 1/2	7/8 x 16	
92-586	586T	38 3/4	35	4	26 3/4	23	22	29	32	1	9 3/4	3/8	7/8 x 3 1/2	7/8 x 16	
92-587	587T	38 3/4	38	4	29 3/4	23	25	29	35	1	9 3/4	3/8	7/8 x 3 1/2	7/8 x 16	
92-588	588T	38 3/4	41	4	32 3/4	23	28	29	38	1	9 3/4	3/8	7/8 x 3 1/2	7/8 x 16	

Mounting Bases



Motor Mounting Brackets

End-Mount Brackets

Part #	Description	Height shaft center to base
92-A8004	45 Adjustable Bracket	4 1/8" - 5 3/8"
92-A8007	A-BR Bracket	-



Pedestal Type Brackets

Part #	Height shaft center to base
92-A8008	4 1/8"
92-A8009	4 9/16"
92-A8010	5 3/8"
92-A8012	6 1/4"
92-A8013*	6 3/8"

* 50 watt motor bracket



4 Bolt Adapter Plate

Part #	Description
92-A278	Used to match Fedders/Clare rectangular mounting stud pattern on 5 5/8" motors



Skeleton Motor Mounting Adapter Kit

Part #	Description
92-A8670	Converts skeleton mount to 3.3" motor diameter mount. Extends mounting bolts from 2" to 3" across



Condenser Fan Rainshields

Part #	Shaft Dia.	Slinger O.D.
92-M3582	1/2"	7"
92-M3584		7 1/2"
92-M3583	5/8"	7"
92-M3585		7 1/2"



Blower Hardware

Part #	Description
92-A8220	Round Flange/ Round Discharge, 2" outlet
92-A8218	Square Flange/Round Discharge, 2" Outlet
92-A8216	Bezel and Screen, 3 1/2" Bolt Circle
92-A8221	Cushion Ring

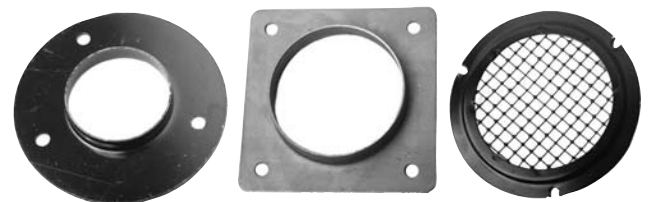

Triangle Brackets

Part #	Description
92-A8120	3.62" Bolt Circle
92-A8005	4.0" Bolt Circle



Motor Mounting Brackets

48/56 Frame Adapter

Part #	Description
92-A4856	Converts 48 to 56 frame motors



Mounting Hardware

Part #	Description
92-A8097	Includes screws, eyelet, speed nut and vibration dampener
92-A8099	Vibration dampener



Blower Motor Mounting Bracket

Part #	Description
92-A8022	Fits 5.0" diameter motors, 9" bolt circle
92-A8023	Fits 5.5" diameter motors, 10" bolt circle



Torsion Flex Bracket

Part #	Description
92-A8617	Fits 5.0" & 5.5 diameter motors
92-A8550	Fits 5.0" diameter motors
92-A8555	Fits 5.5" diameter motors



Heavy Duty Torsion Flex Bracket

Part #	Description
92-A8556	Fits 5.5" diameter motor, 1/2, 3/4, and 1 HP motors, 9" bolt circle, Fits York, Lennox, Keeprite, Olsen, Rheem, Miller, Janitrol
92-A8551	Fits 5.0" diameter motors, 8.37" bolt circle, fits Unilux and Temspec



Lug Mounting Bracket

Part #	Description
92-A8410	Fits 5 5/8" diameter motor, 3/4" holes for large mounting rubber, 1/4" slot for direct mounting screw, two mounting slots accept either 1/4" or 3/4" mounting, bolt circle diameter ranges from 6 3/8" to 7 5/8"



Mounting Bases

Motor Mounting Brackets

Lug Mounting Bracket

Part #	Motor Dia.	Min. Bolt Circle Dia	Max Bolt Circle Dia	Lug Size
92-A8379	3 3/8"	4 5/8"	5 7/8"	Small - 1 3/4"
92-A8380	3 3/8"	5 7/8"	9 7/8"	Large - 4"
92-A8377	4 1/4"	5 1/2"	6 3/4"	Small - 1 3/4"
92-A8378	4 1/4"	6 3/4"	10 3/4"	Large - 4"
92-A8320	5"	6 5/16"	7 9/16"	Small - 1 3/4"
92-A8366	5"	7 9/16"	11 9/16"	Large - 4"
92-A8323	5 5/8"	6 7/8"	8 1/8"	Small - 1 3/4"
92-A8364	5 5/8"	8 1/8"	12 1/8"	Large - 4"



Anti - Windmill Brake

Part #	Description
92-AW12	For 1/2" Shaft
92-AW58	For 5/8" Shaft



Vibration Insulators

Part #	Karmen #	Max. Load in Pounds	
		Compression	Shear
92-A7801	K-30	60	-
92-A7802	K-33	100	-
92-A7803	K-40	25	13
92-A7804	K-44	40	10

Part #	Karmen #	Max. Load in Pounds	
		Compression	Shear
92-A7805	K-47	50	10
92-A7806	K-130	60	-
92-A7807	K-133	100	-



A7801

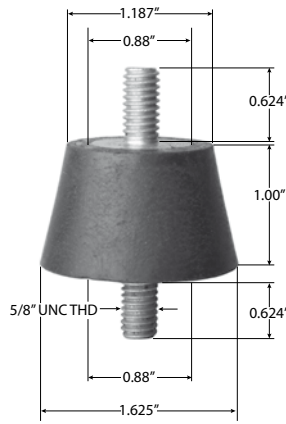

A7802



A7803

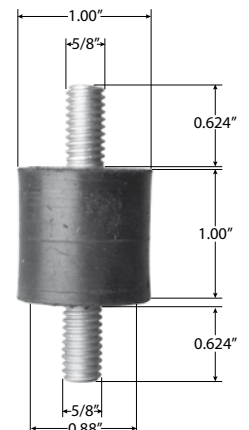

A7804

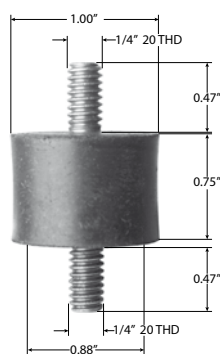

A7805



A7806

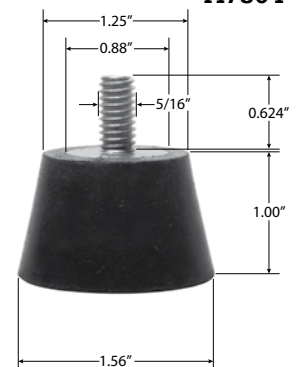

A7807

Components

Shaft Adapters

Shaft Extensions

Part #	O.D.	Length
92-A8115	5/16"	4 3/4"



Tapered Fork

Part #	Description
92-A258	Use for 5/8" shaft dia. or smaller when prying off pulleys, fan blades, etc. Good Leverage - 16" long handle



Shaft Couplers

Part #	I.D.	Length
92-A8114	1/4"	1 1/4"
92-A8116	5/16"	1 1/4"
92-A8111	3/8"	1 1/4"
92-A8112	1/2"	1 1/2"



Threaded to Smooth Shaft Converters

Part #	I.D.	Length
92-A8110	3/16" Threaded to 1/4" Smooth	1 1/2"



Steel Bushings

Part #	Description
92-A8201	5/16" OD x 1/4" ID
92-A8202	3/8" OD x 1/4" ID
92-A8203	3/8" OD x 5/16" ID
92-A8205	7/16" OD x 5/16" ID
92-A8204	7/16" OD x 3/8" ID
92-A8206	1/2" OD x 5/16" ID
92-A8207	1/2" OD x 3/8" ID
92-A8208	1/2" OD x 7/16" ID
92-A8209	5/8" OD x 7/16" ID
92-A8210	5/8" OD x 1/2" ID
92-A8215	5/8" OD x 1/2" ID adapter w/key
92-A8217	3/4" OD x 5/8" ID adapter w/ key



Plastic Bushings

Part #	Description
92-P8121	1/4" OD x 3/16" ID
92-P8122	5/16" OS x 3/16" ID
92-P8123	5/16" OD x 1/4" ID



Motor Speed Controls

Part #	Description
92-A8301	3 Amp, 120 Volt
92-A8302	6 Amp, 120 Volt
92-A8305	10 Amp, 120 Volt
92-A8306	15 Amp, 120 Volt



Silicone

Features

- Contractors Grade
- 300 ml Cartridge
- 24 Per Case

Silicone

Part #	Description
83-SCS1000C	Clear
83-SCS1000W	White
83-SCS1000A	Aluminum
83-SCS1000B	Black
83-IS806	Red "Hi-Temp"

General Purpose Sealant / Adhesives

Contractor grade sealants and adhesives are formulated for professional contractor use only and are available in a variety of general purpose styles for increased convenience and efficiency. The long-term reliability under extremely environmental conditions make these general purpose silicone adhesives the ideal rubber sealant for any interior or exterior job.

83-SCS1000 Application Temperature: -37°C to 60°C (-35°F to 140°F).

Performance Temperature: -62°C to 204°C (-80°F to 400°F).

83-IS806 Performance Temperature: -60°C to 260°C (-75°F to 500°F).

83-SCS1000W
Illustrated



83-IS806
Hi-Temp Silicone



Illustrated

Strapping

Copper & Steel All Purpose Strapping

- The smooth wavy edges make it easier to bend.
- Uniform strength - no weakness at strip holes.
- 1001 uses!

All Purpose Strapping

Part #	Description
15-PC-10	1/2 Gauge x 10' Copper (wavy edges)
15-PC-25	1/2 Gauge x 25' Copper (wavy edges)
15-PS-10	3/4" Gauge x 10" Steel - zinc coated (straight edges)
15-PS-25	3/4" Gauge x 25" Steel - zinc coated (straight edges)
15-PS-50	3/4" Gauge x 50" Steel - zinc coated (straight edges)



15-PC-10
Copper



15-PS-10
Steel

Anti-Vibration Pads

Features

- Can be installed directly under machinery.
- A highly effective Anti-vibration pad.
- Used in residential, industrial and commercial applications.
- Superior anti-vibration pad made from recycled rubber by-products.
Surface - Anti-Skid Honeycomb (shallow hexagons).
Underside - Air circulation grooves every 19 mm (3/4").
- Shock-absorbing properties.
- Water-resistant.
- Coefficient of heat transmission: R-2/ inch.



15-VP44
Illustrated

Anti-Vibration

Alltemp Anti-Vibration Pads designed for industry and machinery applications.

- Air conditioning and heating
- Pumps
- Compressors
- Household appliances
- Construction Applications

Anti-Vibration Pads

Part #	Description
15-VP22	2" x 2" (5.08cm x 5.08cm)
15-VP33	3" x 3" (7.62cm x 7.62cm)
15-VP44	4" x 4" (10.16cm x 10.16cm)
15-VP66	6" x 6" (15.24cm x 15.24cm)
15-VP1212	12" x 12" (30.48cm x 30.48cm)
15-VP1818	18" x 18" (45.72cm x 45.72cm)

All Anti-Vibration Pads 7/8" Thick

Bungee Cords

Part #	Description
12-BC9	23 cm (9")

Heavy Duty Rubber Tie Down Straps

- Available in 9" lengths.
- Sold individually.



15-BC9
Illustrated

Super Value!
Excellent Price!

Applications

- Tie down:
- Cylinders
 - Ladders
 - Tubing to equipment
 - Car trunks
 - Basically anything in seconds!!
- A Must For Every Truck!**

Form Holders

Part #	Description	Form Size	Storage Capacity
15-AH8512	"A"-Holder Compact & versatile!	8½" x 12"	3/8"
15-KK8512	Clip Board Controlled environment applications!	9" x 12½"	1/2"
15-RR8512	Ready-Rite - bottom opening. Portable storage desk & organizer!	8½" x 12"	1½"
15-SN5795	Snapak - side opening. Interior clip & storage forms holder	5 2/3" x 9½"	3/8"
15-SN8512	Snapak - side opening. Interior clip & storage forms holder	8½" x 12"	3/8"
15-SN8515	Snapak - side opening. Interior clip & storage forms holder	8½" x 15"	3/8"
15-SN9512	Snapak - side opening. Interior clip & storage forms holder	9½" x 12"	3/8"

Saunders - The Original Aluminum Form Holders

- Aluminum - heavy duty construction.
- Finish resists weather, stains & mildew.
- Lightweight & built to last!
- A size and style for every need!



"A"-Holder



Clip Board

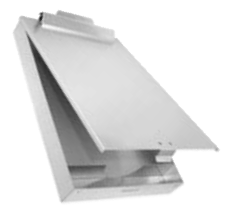

Ready-Rite



Snapak

Privacy cover / hinged writing plate conceals confidential documents, prevents write-through on carbon forms & protects documents from the elements.

Rags

Service & Shop Wipers

Reclaimed rags are sold by net weight for maximum value. Buttons and zippers have been removed. Service & shop wipers use a highly specialized packaging system, which compresses wiping rags into small, compact, clear plastic packages. These packages hold numerous benefits over corrugated boxes.

Package Features

- Compact: 50% space savings.
- Save money on storage.
- Save money on transport.
- Waterproof.
- Stackable.
- Easy-to-handle.
- Extremely attractive for resale purposes.
- Hassle-free dispensing design.

Heavy Duty Service & Shop Rags

Coloured rags equivalent to soft, thick, fleece like sweatshirt material.

Part #	Description	Weight
13-546-5	5 lbs. service size pack.	5 (lbs.)
13-546-10	10 lbs. service size pack.	4.5 kg (10 lbs)
13-546-25	25 lbs. shop size pack.	11.3 kg (25 lbs)

Heavy Duty

- Soft, general purpose wiping cloths are an ideal medium weight rag for absorbing or cleaning liquids, oils and grease. Perfect for auto shops and HVAC/R contractors.

Service Package

20-536-10
10 lbs. Package



Medium Duty Service & Shop Rags

Coloured rags, similar to balbriggan or Polo cotton T-shirt material.

Part #	Description	Weight
13-536-10	10 lbs. service size pack.	4.5 kg (10 lbs)
13-536-25	25 lbs. shop size pack.	11.3 kg (25 lbs)

Medium Duty

- Low cost, no lint, light weight general purpose shop rags. A good general purpose, medium quality wiper at a relatively low cost.

Shop Package

20-536-25
25 lbs. Package



Light/ Medium Duty

- Low cost, no lint, light weight general purpose shop rags. A good general purpose wiper at a relatively low cost.

Light/ Medium Duty Service & Shop Rags

Lightly coloured, near white cotton blend rags, similar to dress shirts or linen sheet material.

Part #	Description	Weight
13-538-10	10 lbs. service size pack.	4.5 kg (10 lbs)
13-538-25	25 lbs. shop size pack.	11.3 kg (25 lbs)

Spray Nine - Premium Multi-Purpose Cleaner/ Degreaser/ Disinfectant

Spray Nine - The First & Still The Best!

Spray Nine cleans hard surfaces such as stainless steel, plastic, tile, rubber, vinyl, fiberglass, porcelain and formica with "spray on-wipe off" ease.

Digs Out Tough Soils Fast!

Enriched with a powerful germicidal, Spray Nine can be used to disinfect and deodorize hospitals, nursing homes, schools, and other institutions where housekeeping is of prime importance. Also controls mold and mildew while destroying bacterial odors.

30 second disinfecting time*!

When used as directed, Spray Nine will disinfect hard non-porous surfaces such as walls, floors, tables, chairs and countertops. Spray Nine kills many bacteria and destroys powerful odors. Used as a hospital grade disinfectant, Spray Nine has been registered by Health and Welfare Canada to kill HIV-1 virus (associated with AIDS), Salmonella, Staphylococci, and Pseudomonas on inanimate surfaces in just 30 seconds. Used regularly, Spray Nine greatly reduces the risk of cross infection.

** Most disinfectant products require a 10 minute contact time to kill germs.*



15-26824
700 ml Pump



15-26825
739 ml Spray



15-26832
946 ml Spray



15-26820
20 L pail



15-26804
4 L Jug

Spray Nine

Part #	Description	Package
15-26824	700 ml pump bottle	12/ctn
15-26825	739 ml spray bottle	12/ctn
15-26832	946 ml spray bottle	12/ctn
15-26804	4 L jug	4/ctn
15-26820	20 L pail	1

Degreasers / Multi Purpose

Spray Nine - Industrial Multi-Purpose Cleaner/ Degreaser

Spray Nine Industrial - The In-process Cleaning & Degreasing Solution!

No other product removes really tough industrial soils as quickly and effectively from manufacturing equipment, engines and machinery to countertops, floors and even washrooms as Spray Nine Industrial. The ready to use formula saves time, labour and money by effectively serving as a all in one cleaner.

Spray Nine - Industrial

Part #	Description	Package
15-13532	946 ml spray bottle	12/ctn
15-13501	3.78 L jug	6/ctn
15-13520	20 L pail	1
15-13545	208 L	1



15-13501
Illustrated



15-13532
Illustrated

Lubricants & Protectants

EZ Telescopic Oiler

The Finest All-Purpose Industrial Oil

The telescoping Spout That Reaches Everywhere! Telescopic Oiler's are specially formulated to reduce wear on moving parts. The oil contains superior additives with anti-rust properties preventing corrosion. The convenient retractable spout makes it easy to get to those hard to reach places.

Oiler

Part #	Description	Package
10-ZS75	118 ml telescopic bottle	12/ctn

EZ Rust Breaker

The Finest All-Purpose Industrial Oil

Alltemp's Rust Breaker is specially formulated to quickly loosen rust and frozen parts. Rust Breaker's demoisturizing agents act as a penetrating oil and superior rust inhibitor. The telescoping spout reaches everywhere! The convenient retractable spout makes it easy to get to those hard to reach places.

Rust Breaker

Part #	Description	Package
10-RB75	118 ml telescopic bottle	12/ctn



10-RB75
Illustrated

10-ZS75
Illustrated

Glass Cleaner

Glass & Stainless Steel Cleaner

All-Purpose Glass Cleaner

Glass & Stainless Steel Cleaner cuts soils instantly on glass, metal, formica and more. A true light duty, all-purpose cleaner that sprays on and wipes clean without streaking, leaving glass and metal sparkling.

Part #	Description	Package
15-C23319	539 g aerosol can style	12/ctn



Fireplace Cleaner

Fireview - Fireplace

Premium Fireplace, Glass & Woodstove Cleaner

Fireview Premium Fireplace Glass & Woodstove Cleaner is formulated to remove stubborn carbon-based soils without tedious scrubbing. Dissolves burned-on carbon deposits and creosote build-up on contact! Tackles smoke residue, soot, ash dust and grime on stone, brick, grates, grills, toolsets, hearth rugs and more. Cleans cast, iron, steel, porcelain, soapstone and enamel surfaces quickly. Safer - no acids, non-caustic and non-corrosive.



15-C15825
Illustrated



15-C15825DSP
Illustrated

Fireplace Cleaner

Part #	Description	Package
15-C15825	739 ml spray bottle	12/ctn

Fireview - Fireplace Display Program

Great Merchandising Solution!

Enhance your fireplace selection with the Fireview Display Program. In-store impulse sales are maximized with Fireview's traffic stopping merchandising unit - Free to every stocking location. This attractive, durable and two shelf unit comes pre-assembled and occupies just 2½ square feet of floor space to display 24 bottles.

Gas Fireplace Cleaner

Part #	Description	Package
15-C15825DSP	(24) 739 ml spray bottles & display merchandiser.	24/ctn

Fireview - Gas

Gas Fireplace Glass Cleaner

Fireview Gas Fireplace Cleaner is specially formulated to remove unsightly "white haze", baked-on smoke, carbon and mineral deposits caused by gas-log fires. Gas fireplace cleaner polishes glass crystal clear and leaves a protective, invisible coating to help prevent future build-up. Fireview Gas Fireplace Cleaner is the sure-fire solution for maintaining the beauty and ambiance of your gas fireplace.



15-C15808
Illustrated



Gas Fireview display merchandiser available upon request.

Gas Fireplace Display Pack

Part #	Description	Package
15-C15808	236 ml bottle	12/ctn

Grez-Off - Industrial Strength Degreaser

Rated #1 in an independent consumer report! A breakthrough degreaser with block buster power. Grez-Off cuts thru heavy grease and soil quickly and effectively on engines, shop machinery, tools, garden & farm equipment, condenser & evaporator coils, gas grills, driveway stains, garage floors and much more. Grez-Off is a great non-flammable alternative to harsh petroleum solvent-based degreasers. Biodegradable, Grez-Off is made with you and the environment in mind.

Part #	Description	Package
15-12632	946 ml spray bottle	12/ctn
15-12620	20 L pail	1
15-12656	57 L	1
15-12645	208 L	1



Hand Cleaners

Grease Grabber

Hand Cleaner

Hard Hitting, Two Fisted Mechanics' Hand Cleaner!

Grease Grabber's improved, fast-breaking, cleaning power cuts through grease, tar, paint, gasket cement, ink and other tough soils on contact. Fortified with soothing lanolin for chapped skin. Pleasant fragrance too! Grease Grabber does not contain any acids or caustic chemicals. Bolstered with additional heavier grade pumice, Knight's extra heavy duty Grease Grabber digs out really nasty soils as the original with soothing skin conditioner for rough hands.



15-C21501
Illustrated

Grease Grabber

Part #	Description	Package
15-C21501	3.78 L pump jug	6/ctn

Poly Scrub

Hand Cleaner

Antibacterial industrial hand cleaner formulated with millions of dirt busting poly "scrubbers" that dig out and mob up even the toughest soils. Removes ink, grease, adhesives, varnish, hydraulic fluids, carbon and other tough industrial soils. Poly Scrub also eliminates nasty odors leaving a fresh lemon/lime fragrance. Solvent free Poly Scrub moisturizes hard working hands and softens skin. Poly Scrub contains chloroxylenol which is a skin substantive antiseptic that destroys micro-organisms, kills germs and reduces the risk of cross infection.



Poly Scrub

Part #	Description	Package
15-C13175	213 g container	12/ctn

Knuckles

Dirt Blocking Hand Cream

The proactive hand cleaner that effectively blocks dirt and grime and allows quick and easy removal of the toughest soils such as grease, tar, asphalt, pitch, caulk, adhesives, cement, glue, paint, ink and more. Simply apply the non-greasy formula with pleasant floral fragrance to hands before they get dirty and tough soils will simply wash away.



15-C46216
Illustrated

Knuckles

Part #	Description	Package
15-C46216	473 ml bottle	12/ctn

Penetrating Oil & Lubricants

Break•Away

Fast Penetrating Oil

Brake•Away is a pure oil-based product that penetrates faster and lubricates longer. It leaves a thicker, longer lasting film vs. light duty solvent-based water displacement formulas. Brake•Away is famous for completing the cycle of lubrication and reducing the coefficient of friction on hot or cold moving parts. Whether it be freeing frozen parts, lubricating moving components or protecting tools and equipment from rust or corrosion, Brake•Away's fast penetrating oil is your anywhere, anytime solution. Contains no ozone depleting CFC's. (pin point applicator straw included).



15-C10
Illustrated

Break Away

Part #	Description	Package
15-C10	369g aerosol can style	12/ctn

Silicone Spray

Synthetic Polymer Lube - The Heavy Duty, Industrial Grade Lubricant!

Silicone Spray's industrial grade formula is an extra heavy-duty concentrate of high quality silicone for maximum performance. Silicone Spray lubricates mechanical parts, conditions rubber, waterproofs and protects against rust or corrosion. Silicone is a stain-free synthetic polymer lubricant that virtually dries to the touch. It reduces friction and lubricates without petroleum oil or grease. Contains no ozone depleting CFC's. (pin point applicator straw included).



15-C33
Illustrated

Silicone Spray

Part #	Description	Package
15-C33	450 ml aerosol can style	12/ctn

White Grease

Heavy Duty Lithium Plus Teflon®

White Grease is a uniquely blended grease that sprays on as a liquid, penetrates and then sets up as a lubricating grease to reduce wear, stop squeaks and repel moisture. Once set-up White Grease remains soft and pliable without drying out. Excellent for applications with close tolerances where metal to metal or metal to plastic lubrication and lasting protection are desired. White Grease works well in both high or low temperatures and in all types of weather. Contains no ozone depleting CFC's. (pin point applicator straw included).



15-C34
Illustrated

White Grease

Part #	Description	Package
15-C34	443.5 ml aerosol can style	12/ctn

Throughout this catalogue certain terms and phrases have been abbreviated. Below is a list of these abbreviations and their meanings.

1/4 x 5/16 Bushing	(1/4" x 5/16" Bush) comes with 1/4" x 5/16 Bushing	Left Hand Thread	Shaft has Thread to Screw on Plastic Fan with a Slot in End
2 Spd-Plug	2 Speed Motor with Special Plug or Leads	Leg Mount	Motor has Feet with Holes Drilled and Tapped
2Pt (2 Point Mount)	2 Extended Bolts and Tapped Holes on Front or Back of Motor	Lyall Plug	Round Plug with Round Pins for Electrical Connection
2Pt-4Pt Mount	Motor has 4 Extended Studs & 2 or 4 may be used for Mounting	Notched Shaft	Shaft has a Flat Cut in it
3Pt (3 Point Mount)	3 Extended Bolts or 3 Tapped Holes on Back of Motor	O.D.	Open Drip Construction
3Pt Wire Mt	Motor has 3 Holes in the Side to Fit in Special Wire Bracket	P.S.C.	Permanent Split Capacitor
A.	Automatic Overload Protection	Pad/Leg	Pad Mount or Leg Mount
A.A.	All Angle Mounting (Vertical Up, Vertical Down or Horizontal)	Pad Mount	Motor has Mounting Hole in Rear Part of the Body
All	Stud, Strap or Base Mounting	Panel	Panel Mounting
Ball	(B) Ball Bearing	Plug	2 or 3 Prong Plug
B.C.	Bolt Circle	R.A.C.	Room Air Conditioning
C Ring Groove	Groove Cut in Shaft for Positioning C Ring Clip	R.P.	Reversing Plug
C.C.W.	Counter Clockwise Rotation	R.S.	Rain Shield
C.F.	Condenser Fan	Rev.	Reversible
C.S.	Capacitor Start	Ring Term	Round Eyelet Terminal
C.W.	Clockwise Rotation	Sleeve	(S) Sleeve Bearing
C/W	Complete With	S.E.	Semi-Enclosed Construction
Capacitor Included	(Cap.Incl.) Motor Shipped with Capacitor	S.F.	Service Factor
Case Bolt	Motor Assembly Bolts Extended for Mounting	S.P.	Shaded Pole
Conduit Box	Conduit Box Attached to Motor for Electrical Connections	S.S.	Stud or Strap Mounting
Cont. Duty	Continuous Duty	SPD/RPM	Number of Speeds and the Highest R.P.M.
Cooling Ring	External Rings Attached to Motor to Assist Heat Dissipation	St.	Strap Mounting
Cut Offs	Cuts in Shaft for Exact Positioning and Ease of Cutting	Spades	Spade Terminals Supplied
Dble Brkt	(Double Bracket) Bracket Welded to Motor	Speed Control	Motor with Additional Lead to be Used with a Variable Speed Control
E.F.	Mounting Ears Flush to End of Motor	Split	Split Phase
E.R.	Mounting Ears Recessed from End of Motor	Stud Mount	Bolts of Motor Extend for Mounting
F	Flat on Shaft	Switch & Cord	Motor has Off/On Switch C/W Cord and Plug Assembly
F.C.	Fan Canopy	T.B.	Triangle Bracket
Flange	Flange Mounting	T.E.	Totally Enclosed Construction
Fleck Plug	Rectangular Plug with Round Pins	THR Shaft	Threaded Shaft-Thread at End of Shaft for Plastic Impellor
Flex	Flex Mounting	Terminals	Spade or Other - Terminals Included in Box
Grooved Shaft	Shaft has a Groove Cut for Positioning	Triangle Brkt	Triangle Bracket with Rubber Grommets Mounted on Front or Back
H.H.	Hex Hubs	U Bracket	(U Brkt) Bracket Attached to Motor
H.V.A.C.	Heating Ventilation and Air Conditioning	V.D.	Vertical Down Mounting
Hayco Plug	Round Plug and Round Pins for Electrical Connection	V.U.	Vertical Up Mounting
Inc.	Included	Vertical Mt	Motor has Special Lubrication System for Shaft Up Operation
Internal Fan	(Int.Fan) Motor has Fan Inside for Additional Cooling Purposes	Watts	(W) Wattage
K	Keyed Shaft	Worm Gear	Gear Attached to Shaft as Drive Unit
K.F.	Keyed Shaft with Flat		
L-K Fitting	For Attaching Conduit Connector		

Motor Type

SKELETON MOTORS	1-7	4.1" DIAMETER MOTORS	24
EVAPORATOR FAN.....	7	4.0" DIAMETER MOTORS	47
VENT FAN KITS.....	1-7	5.0" DIAMETER MOTORS	25-29
3.0" D.C. MOTORS	8	SINGLE SHAFT, 115 VOLTS.....	25-26, 47, 51
3.3" DIAMETER MOTORS	6, 9-17, 22-23	SINGLE SHAFT, 208/230 VOLTS.....	28
OPEN CONSTRUCTION, SINGLE SHAFT.....	9-11, 14	DOUBLE SHAFT, 115 VOLTS.....	27
TOTALLY ENCLOSED, SINGLE SHAFT.....	12-14	DOUBLE SHAFT, 208/230 VOLTS.....	29
OPEN & T.E., 3000 RPM SINGLE & DOUBLE SHAFT.....	14	5.5" DIAMETER MOTORS	30-56
OPEN & T.E., DOUBLE SHAFT.....	15	SINGLE SHAFT, 115 VOLTS.....	30-34, 46-49, 53-56
P.S.C., SINGLE & DOUBLE SHAFT.....	16	SINGLE SHAFT, 208-230 VOLTS.....	35-41, 46, 48, 53-56
TOTALLY ENCLOSED HUBLESS REFRIGERATION.....	17	SINGLE SHAFT, 460 VOLTS.....	44-45, 55-56
FLUE EXHAUST	22-23	SINGLE SHAFT, 575 VOLTS.....	45, 55-56
3.5" TOTALLY ENCLOSED UNIT BEARING	18-20	DOUBLE SHAFT, 208-230 VOLTS.....	42-43
" SQUARE STYLE" TOTALLY ENCLOSED MOTORS.....	21	6.5" DIAMETER MOTORS	48, 49, 50, 53-58

Motor Type

AGITATOR MOTORS	7	DUCT BOOSTERS	77-78
AIR COMPRESSOR MOTORS	50	EVAPORATOR FAN MOTORS	7
AIR CONDITIONING MOTORS		FAN CANOPY MOTORS	55-56, 58
3.3" DIAMETER	15-16	FAN COIL MOTORS	51
5.0" DIAMETER	27, 29	FIREPLACE	
5.5" DIAMETER	34, 42-43	BLOWERS.....	63-67
AXIAL FANS	66-67	BLOWER ASSEMBLIES.....	72-76
BLOWER MOTORS		PELLET STOVE.....	63
AUTOMOTIVE.....	8	FLUE EXHAUST	
BELTED FAN.....	49, 53-54, 57	BLOWERS.....	68-71
COMMERCIAL & INDUSTRIAL - SINGLE PHASE.....	50, 53-56	MOTORS.....	22-23
COMMERCIAL & INDUSTRIAL - THREE PHASE.....	57-58	HEAT RECOVERY VENTILATION MOTORS	10-16
DIRECT DRIVE.....	76	HUMIDIFIER MOTORS	7
FIREPLACE.....	63-67, 72-76	INCREMENTAL MOTORS	24, 27-29, 35-36, 40, 42
FLUE EXHAUST.....	22-23, 68-71	MULTI HORSEPOWER	40, 46
ROOM TO ROOM.....	66, 79	O.E.M. REPLACEMENT MOTORS	79-127
WOODSTOVE.....	9, 15, 17, 72-76, 83	OIL BURNER MOTORS	48
CARBONATOR PUMP MOTORS	50	PELLET STOVE MOTORS	63
CIRCULATOR PUMP MOTORS	52	REFRIGERATION MOTORS	
CONDENSER FAN MOTORS		SKELETON	1-4, 7
ALL ANGLE.....	40, 46	3.3" DIAMETER	9-17
SHAFT UP.....	39	UNIT BEARING	18-20
FAN CANOPY.....	55-56	ELCO "SQUARE"	21
MULTI-HORSEPOWER.....	46	SPECIALTY	100
6.5" DIAMETER		ROOFTOP MOTORS	
D.C.		BELTED FAN MOTORS	53-54
3.0" MOTORS	8	FLUE EXHAUST BLOWERS	68-71
AXIAL FANS	66	FLUE EXHAUST MOTORS	22-23
DIRECT DRIVE BLOWER	76	UNIT BEARING MOTORS	18-20
DIRECT DRIVE MOTORS		UNIT HEATER MOTORS	47-48
115V	25-26, 30-33, 46	VACUUM MOTORS	59-62
208/ 230V	35-38	VENT FAN MOTORS	
460V	44-45	DOMESTIC SKELETON	1-6
575V	45	DOMESTIC 3.3" DIAMETER	6, 9-16
FAN COIL	51	COMMERCIAL	50
MULTI-HORSEPOWER	46	WINDOW AIR CONDITIONING MOTORS	15-16
ROOFTOP SINGLE PHASE	55-56	WOODSTOVE	
ROOFTOP THREE PHASE	58	BLOWERS.....	72-76
		MOTORS.....	9, 15, 17, 83

Accessories

AQUA STATS	51	FORM HOLDERS	163
BEARINGS	145-147	HARD START KITS	139-140
BLOWER HOUSINGS	51	LUBRICANTS	166, 170
BLOWER WHEELS	148-149	MOTOR BRACKETS	21, 158-160
BLOWER WHEEL PULLERS	54	MOUNTING BASES	155-157
CAPACITORS		PULLEYS	149
START	128-129	PUMP COUPLERS	52
RUN	130-131	SHAFTS	145
ACCESSORIES	132	SHAFT ADAPTERS	161-162
CHEMICAL CLEANERS	164-169	SILICONE	162
CLEANING RAGS	164	SOLID STATE CONTROLS	133-138
CONTACTORS	141-144	SPEED CONTROLS	162
FAN BLADES	21, 150-154	TIE-DOWN STRAPS	162-163
FAN GUARDS	21, 67	VIBRATION INSULATORS	160, 163

O.E.M.	Page	O.E.M.	Page
Acorn Woodstoves	79	Johnson,	102
Addison-Comfortaire	79	Keeprite	103,104
Air 2000	79	Kemac	105
Airdex	79	Kingsman	105
Air King	79	Kysor	105
Airtemp	79	Larkin	106
Arkla Tappen, Janitrol	80	Lau	106
Amana	80	Lear	106
American Air Filter	80	Leigh	106
Armstrong	80	Lennox	107,108
Belding	81	Liebert	109
Blanchard Ness	81,82	Life Breath - Nutech	109
Bohn	82	Lincoln	109
Broan	83	Lord Burnham	109
Buck Stove	83	Magic Chef	109
Caloritech	83	Majestic	110
Camco GE, Hot Point, Westinghouse	84	Mark Hot	110
Canadian Armature	84	McQuay Remington	110
Cancoil	84	Miami Carey	111
Carrier	85-87	Miller Furnace	111
Chrysler	88	Montego, Selkirk	111
Chromalox	88	Moyer & Diebel	111
Clare Brothers	89	Napoleon	112
Clawsey - Sohrt	89	Newmac	112
Climetec	89	Nordica	112
Climate Master	89	Nordyne, Frigidaire, Miller	113
Coldstream Refrigeration	90	Nutech	113
Coleman	90	Nutone	113, 114
Comfort Air	90	Olsen	115
Command Air	90	Osburn	115
Copeland	91	Pacific Energy Esteem	115
Cornelius - QBD	91	Polaris	116
Ducane, Lennox Air Flo	92	Prestcold	116
Dundas Foundry	92	QBD	116
Dunham Bush	92	Quadra Fire	116
Duotherm	93	Rapid Refrigeration	116
E.K.W.	93	Ref Plus	116
Elmira Woodstoves	94	Regency	117
Emerson	94	Remington - McQuay	117
F.P.E. (Federal Pioneer - Westcan)	94	Remington Singer	117
Fedders	95	Reversomatic	117
Flame Master	95	Reznor	117
Foster Refrigeration	95	Rheem Ruud	118
Friedrich	96	Scotsman	118
Frigidaire	96	Security	119
Goodman-Janitrol	96	Selkirk Metalbestos	119
Grimsby	97	Singer	119
G.S.W.	97	Snyder General	119
Habco (H.A. Brown)	97	Tecumseh	120
Hartell	97	Temspec	120
Hearth & Home Technologies	97	Torin	121
Heat-N-Glow	98	Trane	121, 122
Heatilator	98	Tweed Steel	123
Heritage Energy Fireplaces	98	Tyler	123
Heil - Quaker	98	Unilux	123
Hill	99	Vanee	123
Honeywell	99	Venmar	124
Hunter	99	B.D. Waite	124
Hussmann	100	Weather King	124
ICP	101	Westcan	124
Ideal	102	Whirpool - Inglis	124
Intercity	102	Whitefield Auger Motors	124
Jennair	102	York	125 - 127